

Laboratory Instruments



GERMAN ENGINEERING
with German Quality Test Certificate

ISO 9001 Certified
ISO 13485 Certified Products
CE-Marked Products
CE-MDD Marked Products
Validation (IQ & OQ) Service



Witeg Labortechnik GmbH is one of the leading manufacturers and suppliers of laboratory glassware, custom-built glassware, liquid handling articles, electronic Wisd instruments and equipment.

Witeg Labortechnik GmbH was founded in the year 1960 to develop glass devices. Nowadays, we can offer beside glass articles almost everything for the laboratories. The products fulfil the very high demands in the chemical, pharmaceutical and medical sectors and are delivered to **more than 100 countries worldwide**. Our actual product range covers **more than 30.000 products** which are mostly **ex stock** available.

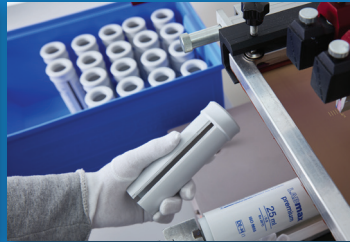

Our company's philosophy is preliminary **Quality for the customer**. The **quality management system** of witeg Labortechnik has been officially **certified** already in 1994 by the **DIN EN ISO 9001** to guarantee the highest international quality standards. We permanently perform investment in qualified and engaged employees to reach the optimum level of quality. Furthermore, we emphasize to make use of latest computer-aided equipment and technique which is necessary to obtain best performance and utmost quality.

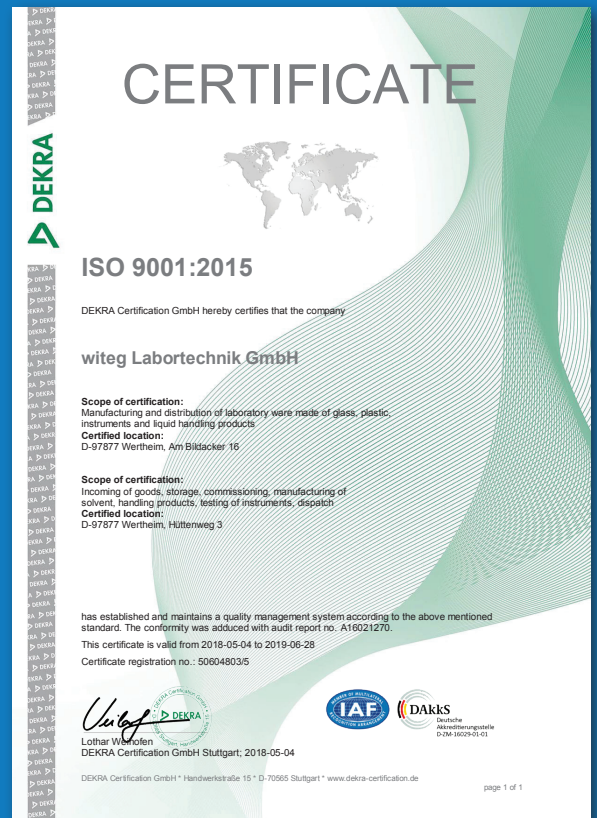

German engineering and technology knowledge is the footing of many inventions especially in the laboratory industry when it comes to devices and consumables. Our Wisd-devices are the result of our ideas and are developed in cooperation with the excellent economical manufacturing philosophy of our South Korean partner.

The used materials are of superior quality in order to ensure a long-lasting, interference-free application. The electronic components are always up-to-date and we are continuously working on their further development.

In general, all devices have the advantage that they are identical when it comes to the design and moreover that all components, technical elements, spare parts etc. match the same manufacturing philosophy.

This advantage becomes very clear during a potentially necessary after sales service since we are capable of helping in a warranty case.

The largely identical spare parts are easy to exchange and facilitate the technical laboratory organization significantly. The variety and the wide range of products form the same technology therefore speaks for itself.

Due to the mentioned advantages, we were able to reduce the production costs, so that in general we can offer our products competitively and at reasonable prices.

Before the dispatch, each device is individually check twice regarding the functionality. Therefore, we always add a quality examination certificate, which contains depending on the priority the end control data true to the motto:

GERMAN ENGINEERING with German Quality Test Certificate

The whole process contains also the guidance of **ISO 9001**.

A price comparison therefore pays off within a delivery warranty time of 2 years.



Content



HEATING

Hotplate	17
Magnetic stirrer with hotplate.....	22
Dry bath (Incubator).....	30
Heating mantle	34
Heating tape	47
Bath (water, oil, viscosity, circulation, shaking).....	48
Incubator (standard, B.O.D., shaking).....	58
Growth chamber	70
Oven (gravity-/forced-air, vacuum)	74
Muffle furnace.....	80

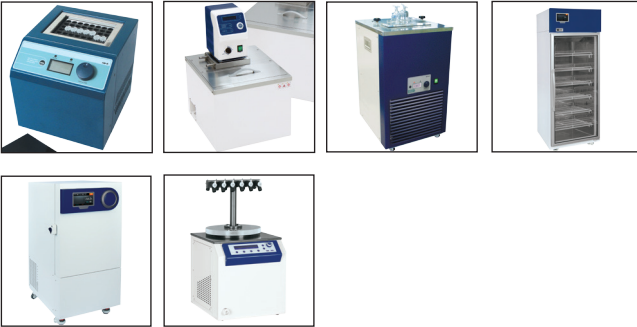

COOLING & FREEZING

Dry bath (Incubator).....	30
Bath (circulation).....	86
Cold trap	88
Refrigerator.....	90
Freezer	96
Freeze dryer	102



MIXING & SHAKING

Magnetic stirrer with hotplate.....	22
Dry bath (Incubator).....	30
Bath (shaking)	55
Incubator (shaking).....	66
Magnetic stirrer	107
Jar tester.....	111
Overhead stirrer.....	112
Homogenizer	122
Vortex mixer.....	126
Shaker	128
Rotator.....	133
Rocker	134
Ball mill	135



SAFETY & PURIFICATION

Ultrasonic cleaner	137
Clean bench	141
Fume hood wet scrubber.....	142
Fume hood	142
Autoclave.....	145

SEPARATION & FILTRATION

Centrifuge	149
Evaporator	152
Filtration (filter holder).....	156
Filtration system	166
Manifold	168
Suction system	173



MISCELLANEOUS

Balance.....	181
Moisture analyzer	184
Colony counter	185
Peristaltic pump	186
Vacuum pump (oil-free)	188
Vacuum pump (chemical resistant)	193
Compressor (oil-free).....	197
Air supply system	198
Gel documentation system.....	199
Electrophoresis.....	201
UV transilluminator	202
Water distillation apparatus	203
Plate stand & accessories	214
Lab burner & accessories.....	216
Lab jack	217
Stopwatch, counter, timer	217



Consumables

Magnet stirrer bar	28
Volumetric flask	220
Beaker	223
Erlenmeyer flask.....	224
Graduated cylinder	226
Bottles (Laboratory, B.O.D., Meplat, Culture).....	228
Culture flasks.....	232
Extraction apparatus.....	233
Separatory funnels	233
Staining jars.....	235
Petri dish.....	235
Tubes (test, culture, centrifuge).....	236
Brush	241
Parafilm	241
Cleaning concentrate.....	241
Crucibles.....	242
Weighing accessories.....	243



Index

A

Air supply system	198
Alarm system.....	101
Amber flasks.....	221,224
Analytical balance.....	181-183
ASTM tubes.....	239
Autoclave.....	144-146

B

Bacteria counting.....	185
Balances.....	181-184
Ball mill	135
Baskets.....	137-139
Baths	48-55,88
circulation water bath ..	52-54,86-87
cold trap bath.....	88
oil bath.....	49
ultrasonic bath.....	137-139
viscosity water bath.....	51
water bath.....	48,50-55
extraction.....	50
shaking.....	55

Beaker	223
Biostill	203
BioVac	173
Blutbank.....	93
B.O.D. bottles	231
B.O.D. incubator.....	62-63
Bossheads.....	215
Bottles.....	228-231
Brushes	241
Bunsen burner.....	216
Burner.....	216
Bunsen	216
gas, digital	216
Meker	216
safety.....	216

C

Cell culture aspiration.....	166,173-177
Centrifuge.....	149-150
mini.....	149
Centrifuge tubes	236-239
Circulation water bath.....	52-54,86-87
Clamps	215
Clean bench	140-141
Cleaning concentrate.....	241
Cold trap bath.....	88
Colony counter	185
Compressor.....	197
Conical flasks	224-225
Consumables.....	219-243
Beaker	223
Bottles	228-231
Brushes	241
Crucibles	242
Culture tubes	236
cylinders	226-227

Erlenmeyer flasks.....	224-225
Petri dishes.....	235
Racks	240
Test tubes.....	236-239
Weighing accessories	243
Controller.....	46
Coplin	235
Counters.....	185,217
Couplings.....	121
Crucibles.....	242
Cryo-boxes	101
Culture tubes	236-239
Cylinder, graduated	226-227

D

Digital gas burner	216
Digital timer.....	217
Distillation apparatus	203
Drying blocks	33
Drying systems.....	102-103

E

Electrophoresis.....	199-202
Software	201
Environmental test chamber.....	70-72
Erlenmeyer flasks.....	224-225
Evaporating flasks	153
Evaporator.....	152-153
Extraction water bath.....	50

F

Filter funnels.....	156-165
Filter holder.....	156-164
glass	156-158
PES	160,162-163
stainless steel.....	159,161,164
Filtration.....	156-172
funnels.....	156-164,171
manifolds.....	169-171
sets.....	165,172
Filtration systems.....	156-164
glass	156-158
PES	160,162-163
stainless steel.....	159,161,164
Flasks	103,220-222
freeze drying.....	103
volumetric.....	220-222
Flask shaker ..	128-131,129-132,130-133
Flocculation test.....	111
Freeze dryer	102-103
Freezer	95-101
-35°C	100
-86°C	96,98-99
-95°C	97
Fume hood	140-141
Furnace	80-82

Galaxy 330	185
Gas burner.....	216
Gel documentation system.....	199-202
Software	201
Glass stirring bars.....	28
Graduated cylinder	226-227
Growth chambers	70-72

H

Heating mantle	34-46
controller.....	46
for beaker	34-36
for big flasks	41
for flasks	37-40,38-41
for reaction vessels	42-44
multi-place	45
Heating tapes	47
HEPA filter	141
High-speed stirrer	114-116
High-torque stirrer.....	117-119
Homogenizer	122-125
analog.....	123-124
digital	122
Hose barsbs	195
Hotplates	17-20
analog.....	19
digital	16-17,17-18
large-type	20
Hotplate with magnetic stirrer.....	21-30
analog.....	25-26
square-type	25
digital	22-25,23-26,26
multi-type.....	26
square-type	24

I

Impellers	120
Incubator.....	56-75
forced-air	60-66
4 chambers	64
B.O.D.	62-63
gravity-air.....	58-59
growth chamber.....	70-72
shaking	66-69

J

Jacks	217
Jars, staining	235
Jar tester.....	111

L

Lab-jacks	217
Laboratory refrigerator.....	90-93
Lafil	166-167
Laminar flow clean bench.....	140-141

M

Magnetic stirrer.....	106-111
-----------------------	---------

analog.....	109
digital.....	107-108,110
multi-type.....	110
Magnetic stirrer with hotplate.....	21-30
analog.....	25-26
square-type.....	25
digital.....	22-25,23-26,26
multi-type.....	26
square-type.....	24
Manifolds.....	168-172
Microplate manifold.....	168
with spin-lock.....	171
with stopper.....	169-170
Meker burner.....	216
Membrane filtration.....	156-165
Microplate manifold.....	168
Mills.....	135
Mischapparate	
Vortex Mixer.....	127
Mixers.....	66-69,105-133
Ball mill.....	135
Homogenizer.....	122-125
Jar tester.....	111
Magnetic stirrer.....	106-111
Magnetic stirrer with hotplate.....	21-30
Overhead stirrer.....	112-121
Rocker.....	134
Rotator.....	133
Shaker... 128-130,129-131,130-132	
Shaking incubator.....	66-69
Vortex mixer.....	126
Moisture analyzer.....	184
Moisture traps.....	195
Muffle furnace.....	80-82
Multifunktionsmischer.....	131
Multifunktionsschüttler.....	131
Multi plates.....	110
MultiVac.....	169-172

O

Oil bath.....	49
Orbital shaker.....	128,129,130
Ovens.....	74-82
forced-air.....	76-77
gravity-air.....	74-75
muffle furnace.....	80-81
vacuum.....	78-79
Overhead stirrer.....	112-121
analog.....	116,119
high-speed.....	116
high-torque.....	119
digital.....	114-115,117-118
high-speed.....	114-115
high-torque.....	117-118

P

Parafilm.....	241
Peristaltic pump.....	186-187
Petri dishes.....	235

Phoretix 1D.....	201
Plate stands.....	125,214
Platforms.....	132
Portable suction system.....	173-175
Propellers.....	120
PTFE-stirring bar.....	28
Pumps.....	186-199
accessories.....	195-196
air supply system.....	198
chemical resistant vacuum.....	193-194
oil-free compressor.....	197
oil-free vacuum.....	188-192
peristaltic.....	186-187

R

Racks.....	240
Racks, freezers.....	101
Reaktorsystem.....	208-213
Receiver flasks.....	196
Reciprocating shaker.....	130
Refrigerator	
pharmaceutical.....	93
Refrigerator, laboratory.....	90-93
Remote alarm system.....	101
Rings.....	215
Rocker.....	134
Rods for plate stands.....	214
Rotary evaporator.....	152-153
Rotator.....	133

S

Safety beaker.....	29
Safety burner.....	216
Separating funnel shaker.....	
128-131,129-132,130-133	
Separatory funnels.....	233-234
Shaker.....	128-130,129-131,130-132
orbital motion.....	128
reciprocating motion.....	130
Shaking incubator.....	66-69
Shaking water bath.....	55
Software, gel documentation system.....	201
Spring rack.....	132
Staining jars.....	235
Stand rods.....	214
Steam sterilizer.....	144-146
Stirrer.....	22-30,23-31,107-125
Homogenizer.....	122-125
Jar tester.....	111
Magnetic stirrer.....	107-110
Magnetic stirrer with hotplate.....	22-30,23-31
Overhead stirrer.....	114-121
Stirrer couplings.....	121
Stirring bars.....	28
Stirring rods.....	121
Stopper.....	224
Stopwatches.....	217
Suction cap.....	175

Suction system.....	173-177
portable.....	173-175
universal.....	176-177

T

Tapes, heating.....	47
Temperature recorder.....	101
Test tube mixer.....	126
Test tubes.....	236
Thermal printer.....	181-184
TotalLab™ Quant.....	201
Transilluminator.....	202
Trays.....	240
Triangles.....	217
Tripods.....	217
Tubing pumps.....	186-187

U

Ultrasonic cleaner.....	137-139,146
analog.....	137
digital.....	138-139,146
Universal clamps.....	215
Universal suction kit.....	176-177
USP graduated glassware.....	222,227
UV transilluminator.....	202

V

Vacuum filtration system.....	156-167
Vacuum manifolds.....	168-171
Vacuum oven.....	78-79
Vacuum pump.....	152,165,188-192,193-194
Vacuum regulator.....	195
Vakuumentorset.....	211-213
Vapor traps.....	195
Viscosity water bath.....	51
Volumetric flasks.....	220-222
Vortex mixer.....	126

W

Waste bottles.....	196
Water bath.....	48,50-55,86-87
Water distillation apparatus.....	203
Water purification system.....	204-207
Weighing accessories.....	243
Wire gauzes.....	217
witegvapor.....	152-153
Workbench.....	140-141

Anytime - Anywhere

SMART-Lab™



The all new **SMART-Lab™** devices enable an unprecedented workflow in all laboratories. Limited research manpower and limited surveillance time on-site belong to the past.

The outstanding features of **SMART-Lab™** are:

Remote controlling
Remote monitoring

Wherever you have access to the internet with your Android® or Apple® smart-phone and tablet you have the possibility to manage the devices within your laboratory - **no matter where in the world you are!**

connected laboratory



WiRe® App service

Check and manage your **SMART-Lab™** devices whenever and wherever it is necessary - in real-time:

Temperature
Humidity
Illumination

Also receive push-notifications for different errors like **opened doors** or **power failures**.



Please note: The ongoing development of SMART-Lab™ and its features ensure continual software updates, new options and improvements!

SMART-Lab™

Controller

Anytime - Anywhere
connected laboratory



User interface

All settings are made on the touch screen of the **SMART-Lab™** controller. The Android®-based 4" or 7" controller has an easy to understand and intuitive UI which is fully controllable by touch input.

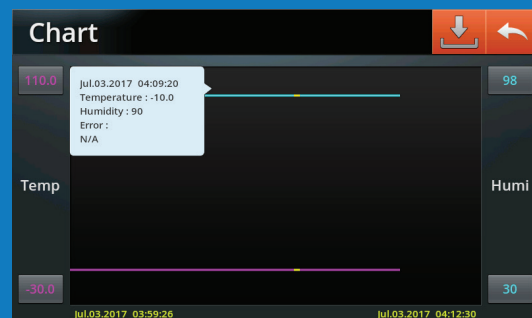

Graphs & data recording

Watch all heating and cooling circles in „Graph view“ for live logging and controlling. The graph is completely zoomable for a more detailed view.

All data is recorded and can be transferred to a computer for analysing processes via USB stick.

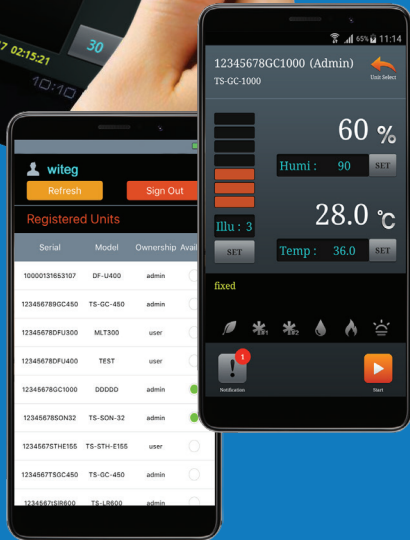

Remote control

Check and manage the **SMART-Lab™** device via smartphone or tablet. Settings like temperature, humidity and illumination (if available) can be changed and monitored in real-time.

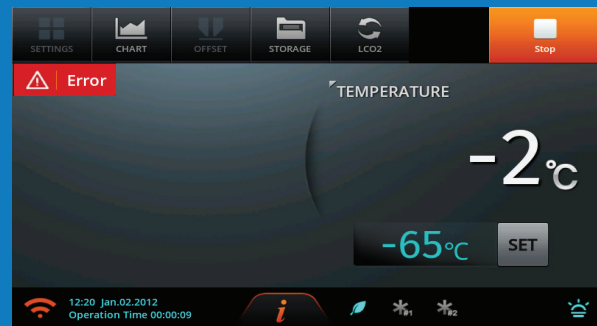

Self diagnostic function & push notification

Internal sensors provide highest accuracy and stability. All errors will be displayed on the touch screen.

The **WiRe™ App** service allows push notifications to smartphone or tablet for major failures like „door opened“ or „power failure“.

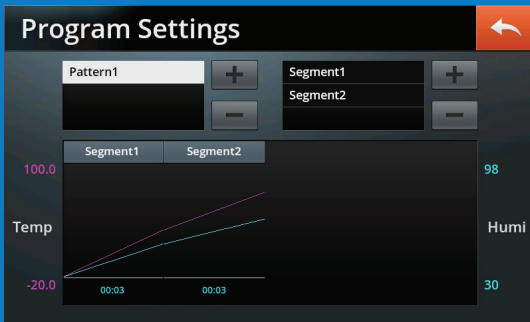

Program control function

Variable program settings for multiple patterns with multiple settings can be made directly via touch input. Additionally, the set patterns will be graphically shown in a preview window.

User registration management

The built-in user management allows multiple users to manage the device as well as management of multiple devices by one user - or a group of users.

What is IQ and OQ?

According to your DQ (Design Qualification) needs, witeg offers a highly qualified IQ (Installation Qualification) and OQ (Operational Qualification).

To meet all mentioned aspects of a DQ please get into contact with our sales team and get an individual consulting before buying a device. We are anxious to satisfy all customer needs and will attend every device from the production process right up to the delivery and if desired up to the installation at your site.

What does IQ and OQ contain?

IQ

INSTALLATION QUALIFICATION

Documented verification of the device according to following aspects:

- integrity of scope of delivery
- identification of device (serial number)
- configuration and technical structure
- hard and software configuration
- network connection (if available)
- site and wiring
- creation of device journal
- determine a responsible person
- briefing of personal for OQ

OQ

OPERATIONAL QUALIFICATION

Approved and documented operability of the device in terms of:

- display
- LEDs
- functions (depending on device):
 - ◇ temperature setting
 - ◇ pressure setting
 - ◇ speed setting
 - ◇ CO² regulation
 - ◇ vacuum regulation
 - ◇ fan speed setting
 - ◇ illumination setting
 - ◇ timer setting

Which devices are IQ- and OQ-capable?



Oven



Autoclave



Growth chamber



Freezer

IQ | OQ



Incubator



Shaking water bath



Shaking incubator

What to expect from IQ and OQ?

After the IQ process a completely filled out **IQ audit report** is created on basis of an elaborated **IQ inspection plan** according to all aspects of the specific device. Every step of production is reviewed, controlled and tested before delivering a device to the customer - all for your added value!

The OQ process makes a full field test at the customer's site. It will be arranged and installed according to necessary standards to guarantee a faultless working. It is very important that the running tests of a device are made together with professionals - you are the expert and user! Every step will be guided, reviewed and documented. After completing the arrangement, installation and tests a filled-out **OQ audit report** will be created according to **OQ inspection plan**.

Please note:

The IQ and OQ qualification is only possible for new acquired devices. The services must be bought together with the device. As the IQ is affecting the production process this can't be bought when the device has been delivered to a customer. Thus, the OQ can't be bought separately as it is necessary that the IQ has been made in advance.

HEATING



HEATING

Hotplate	17
Magnetic stirrer with hotplate.....	22
Dry bath (Incubator).....	30
Heating mantle	34
Heating tape	47
Bath (water, oil, viscosity, circulation, shaking).....	48
Incubator (standard, B.O.D., shaking)	58
Growth chamber	70
Oven (gravity-/forced-air, vacuum)	74
Muffle furnace	80

Hotplate

HP-500

NEW

Highest performance

- powerful: temperature up to 500 °C
- protection against corrosion due to the smart design
- superior heat- and chemical-resistant full ceramic plate
- precise temperature by digital feedback control

Highest convenience

- intuitive and very easy to use control elements
- illuminated digital display for easy setting
- easy to clean full ceramic plate

Highest user safety

- hot top indicator for temperatures over 50°C
- high quality insulation to protect user and device against heat damage
- two independent internal sensors for accurate temperature and overheating protection

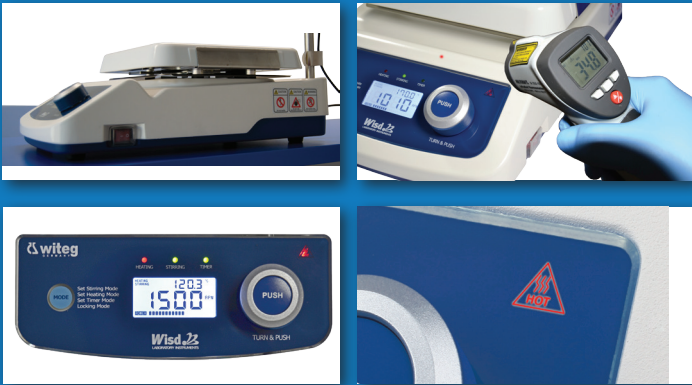

Protection

Two features protect the device from internal corrosion and prolong its life time: the **closed coverage type** and the **intelligent fluid management system**, which leads off accidentally spilled liquids away from the interior of the device.

Surface

The **superior full ceramic plate** achieves up to 500°C, is **resistant against aggressive chemicals** and **easy to clean**.

Housing

The **die-cast case** with **high-quality insulation** ensures **user safety** during operation at high temperatures. The **minimized heat transfer** from the plate to the inside also ensures a **longer life time**.

Temperature control & safety

Two independent internal temperature sensors assure **accurate temperature control** and **prevent from malfunction or danger** caused by overheating.



Accessories

The **external temperature sensor** allows **accurate temperature** due to **digital feedback control system**.

Safety first

Hot top indicator lamp illuminates when temperature on the plate is over 50°C.

Controller

New **Jog-Dial “Turn + Push”** and **touch button** are designed for **intuitive, easy and direct use**.

Hotplate

digital, up to 500°C, solid ceramic plate 200x200 mm

NEW

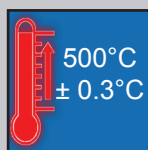

HP-500 Set

HP-500 digital, 500°C

Ideal for:

- sample drying and general lab heating applications where high temperature is needed

Features:

- digital display with backlight
- new design: lighter and more compact than the previous model
- high-quality solid ceramic plate 200x200 mm, up to 500°C
- heat-, chemical- and acid-resistant
- perfect heat uniformity from the inner to the edge
- no liquid can get into the body
- powder-coated aluminium body
- CE certified and unique serial number for tracing

Safety mechanism:

- hot top indicator lamp
- timer 99h 59min with timer-end signal
- ideal fourfold insulation: BTU, ceramic paper and 2 x SUS
- error status
- locking mode
- operation LEDs

Controller:

- **Jog-Dial** controller with touch-button for precise temperature control

Model	HP-500
Body	powder-coated aluminium
Plate	solid ceramic plate, 200x200 mm
Temperature range & accuracy	max. 500°C, ±0.3°C
Temperature resolution	0.1°C display, 0.5°C control
Temperature uniformity	specialty designed heating module: temperature difference less than 10%
Heating power / consumption	850W
Timer & alarm	99hr 59min (with continuous run), error status and timer-end
Display	digital LCD with backlight function
Controller	digital feedback controller with Jog-Dial (Turn+Push) and touch-button
Safety circuit	overheat protection, hot top indicator LED lamp
Permissible temperature & RH %	ambient temperature +5 ~ 50°C, 85% RH
Dimension & weight	220 x 332 x 114 mm, 3.8 kg
Power supply	1 Phase AC 120V, 60 Hz or AC 230V, 50/60 Hz
Order number 230V	Set: DH. WHP01500 Unit: DH.WHP00500
Order number 120V	Set: DH. WHP01501 Unit: DH.WHP00501

Set includes: Unit HP-500
 Temperature probe SS500
 Stand rod RD200, Ø12xL450 mm, stainless steel
 Holder / clamp / clip CL220 for fixation of temperature probe

Accessories: External temperature probes, stand rod and holder / clamp / clip on page 27

Hotplate

digital, up to 500°C, solid ceramic plate 200x200 mm

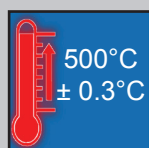

HP-500D Set

HP-500D digital, 500°C

Ideal for:

- sample drying and general lab heating applications where high temperature is needed

Features:

- up to 500°C
- digital display with backlight
- high-quality solid ceramic plate 200x200 mm
- heat-, chemical- and acid-resistant
- perfect heat uniformity from the inner to the edge
- no liquid can get into the body
- powder-coated aluminium body
- CE certified and unique serial number for tracing

Safety mechanism:

- hot top indicator lamp
- high quality insulation (BTU)
- timer 99h 59min with timer-end signal
- error status
- locking mode
- operation LEDs

Controller:

- **Jog-Dial** controller with touch-button for precise temperature control

Model	HP-500D
Body	powder-coated aluminium
Plate	solid ceramic plate, 200x200 mm
Temperature range & accuracy	max. 500°C, ±0.3°C
Temperature resolution	0.1°C display, 0.5°C control
Temperature uniformity	specialty designed heating module: temperature difference less than 10%
Heating power / consumption	850W
Timer & alarm	99hr 59min (with continuous run), error status and timer-end
Display	digital LCD with backlight function
Controller	digital feedback controller with Jog-Dial (Turn+Push) and touch-button
Safety circuit	overheat protection, hot top indicator LED lamp
Permissible temperature & RH %	ambient temperature +5 ~ 50°C, 85% RH
Dimension & weight	205x345xh135 mm, 3.3 kg
Packaging size	400x280xh160 mm, unit: 4.8 kg, set: 5.4 kg
Power supply	1 Phase AC 120V, 60 Hz or AC 230V, 50/60 Hz
Order number 230V	Unit: DH.WHP05020 Set: DH.WHP04020
Order number 120V	Unit: DH.WHP05021 Set: DH.WHP04012

Set includes: Unit HP-500D
 Temperature probe Ø4xL250 mm, cable length: 190 mm
 Stand rod Ø12xL450 mm with thread, stainless steel
 Holder / clamp / clip for fixation of temperature probe

Accessories: External temperature probes, stand rod and holder / clamp / clip on page 27

Hotplate

digital, up to 380°C, ceramic-coated plate

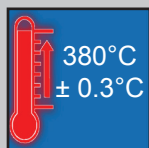

HP-30D

HP-20D Set

HP-D digital, 380°C

Ideal for:

- sample drying and general lab heating applications

Features:

- up to 380°C
- digital display with backlight
- ceramic-coated aluminium plate 180x180 / 260x260 mm
- heat-, chemical- and restricted acid-resistant
- powder-coated body
- CE certified and unique serial number for tracing

Safety mechanism:

- timer 99h 59min with timer-end signal
- error status
- locking mode
- operation LEDs

Controller:

- **Jog-Shuttle** controller with touch-button

Model	HP-20D	HP-30D
Body	powder-coated aluminium	powder-coated steel
Plate	ceramic-coated aluminium 180x180 mm	ceramic-coated aluminium 260x260 mm
Temperature range & accuracy	max. 380°C, ±0.3°C	
Temperature resolution	0.1°C display, 0.5°C control	
Temperature uniformity	specially designed heating module: temperature difference less than 10%	
Heating power / consumption	600W	1.2kW
Timer & alarm	99hr 59min (with continuous run), error status and timer-end	
Display	digital LCD with backlight function	
Controller	digital feedback controller with Jog-Dial (Turn+Push) and touch-button	
Safety circuit	overheat protection	
Permissible temperature & RH %	ambient temperature +5 ~ 50°C, 85% RH	
Dimension & weight	206x307xh99 mm, 2.8 kg	286x387xh99 mm, 3.2 kg
Packaging size	400x280xh200 mm, 5 kg	430x320xh200 mm, 5 kg
Power supply	1 Phase AC 120V, 60 Hz or AC 230V, 50/60 Hz	
Order number 230V	Unit: DH.WHP03020 Set: DH.WHP03021	Unit: DH.WHP03022 Set: DH.WHP03023
Order number 120V	Unit: DH.WHP02020 Set: DH.WHP02021	Unit: DH.WHP02022 Set: DH.WHP02023

Set includes: Unit HP-D
 Temperature probe Ø4xL250 mm, cable length: 190 mm
 Stand rod Ø12xL450 mm, stainless steel (stand rod for HP-20D with thread)
 Holder / clamp / clip for fixation of temperature probe

Accessories: External temperature probes, stand rod and holder / clamp / clip on page 27

Hotplate

analog, up to 380°C, ceramic-coated plate

HP-A analog, 70°C - 380°C

Ideal for:

- sample drying and general lab heating applications

Features:

- up to 380°C
- ceramic-coated aluminium plate 180x180 / 260x260 mm
- heat-, chemical- and restricted acid-resistant
- powder-coated body
- CE certified and unique serial number for tracing

Safety mechanism:

- operation LEDs

Controller:

- **PWM controller**

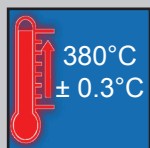

HP-20A

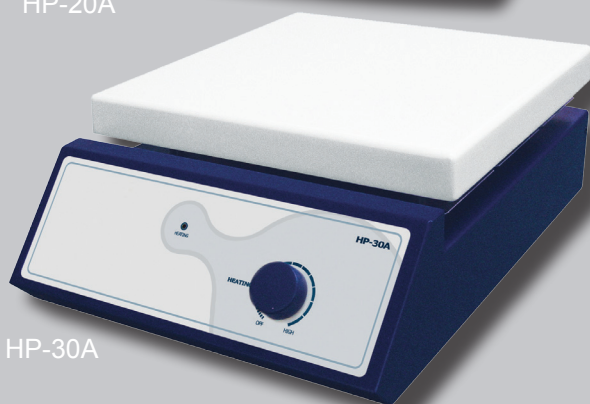

HP-30A

Model	HP-20A	HP-30A
Body	powder-coated aluminium	powder-coated steel
Plate	ceramic-coated aluminium 180x180 mm	ceramic-coated aluminium 260x260 mm
Temperature range & accuracy	70°C - 380°C, ±0.3°C	
Temperature resolution	0.5°C control	
Temperature uniformity	specially designed heating module: temperature difference less than 10%	
Heating power / consumption	600W	1.2kW
Controller	superior linearity PWM Controller	
Permissible temperature & RH %	ambient temperature +5 ~ 50°C, 85% RH	
Dimension & weight	206x307xh99 mm, 2.8 kg	286x387xh99 mm, 3.2 kg
Packaging size	400x280xh200 mm, 5 kg	430x320xh200 mm, 5 kg
Power supply	1 Phase AC 120V, 60 Hz or AC 230V, 50/60 Hz	
Order number 230V	DH.WHP03120	DH.WHP03121
Order number 120V	DH.WHP02120	DH.WHP02121

Accessories:



Stand rod RD200 Ø12xL450 mm with stainless steel thread

DH.WHP503036

Holder, clamp and clip

DH.WHP503012

Hotplate

digital, up to 350°C, large ceramic-coated aluminium surface 310x620 mm

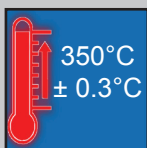

HPLP large-type, digital, 350°C

Ideal for:

- sample drying and general lab heating applications where a large surface is needed

Features:

- up to 350°C
- ceramic-coated aluminium plate 310x620 mm
- heat-, chemical- and restricted acid-resistant
- aluminium body
- CE certified and unique serial number for tracing

Safety mechanism:

- timer 99h 59min with timer-end signal
- error status
- locking mode
- operation LEDs

Controller:

- HPLP-C-P: **Jog-Shuttle** controller with touch-button
- HPLP-C-R: **Remote controller** with touch-button

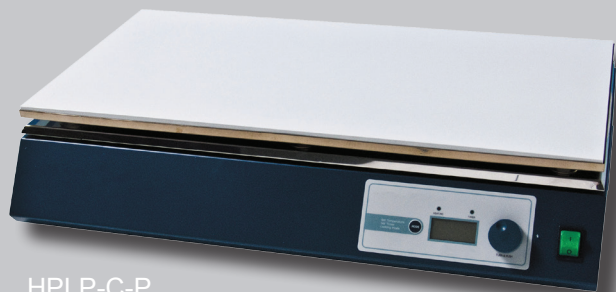

HPLP-C-P

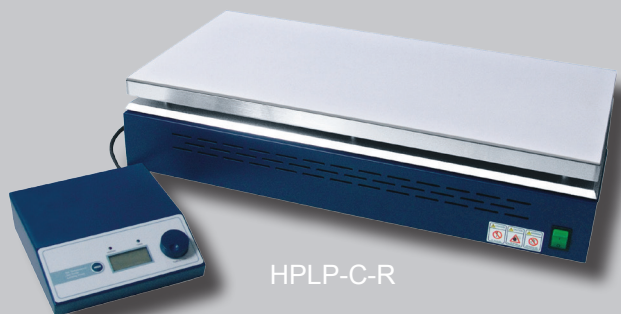

HPLP-C-R

Model	HPLP-C-P	HPLP-C-R
Body	aluminium	
Plate	ceramic-coated aluminium 310x620 mm	
Temperature range & accuracy	max. 350°C, ±0.3°C	
Temperature resolution	0.1°C display, 0.5°C control	
Temperature uniformity	specially designed heating module: temperature difference less than 10%	
Heating power / consumption	2kW	
Timer & alarm	99hr 59min (with continuous run), error status and timer-end	
Display	digital LCD with backlight function	
Controller	built-in digital PID controller	digital remote controller
Safety circuit	overheat protection	
Permissible temperature & RH %	ambient temperature +5 ~ 50°C, 85% RH	
Dimension & weight	630x360xh150 mm, 16 kg	
Packaging size	750x430xh220 mm, 18 kg	
Power supply	1 Phase AC 120V, 60 Hz or AC 230V, 50/60 Hz	
Order number 230V	DH.WHP03024	DH.WHP03025
Order number 120V	DH.WHP02024	DH.WHP02025

Magnetic stirrer with hotplate

MSH-500

NEW

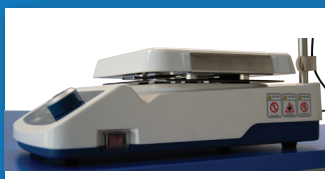

Highest performance

- powerful: stirring capacity up to 20 l, temperature up to 500 °C, stirring rate up to 1.500 rpm
- protection against corrosion due to the smart design
- superior heat- and chemical-resistant full ceramic plate
- strong but quiet motor, made for a long life time
- precise temperature by digital feedback control

Highest convenience

- intuitive and very easy to use control elements
- illuminated digital display for easy setting
- easy to clean full ceramic plate

Highest user safety

- hot top indicator for temperatures over 50°C
- high quality insulation to protect user and device against heat damage
- two independent internal sensors for accurate temperature and overheating protection

Protection

Two features protect the device from internal corrosion and prolong its life time: the **closed coverage type** and the **intelligent fluid management system**, which leads off accidentally spilled liquids away from the interior of the device.

Surface

The **superior full ceramic plate** achieves up to 500°C, is **resistant against aggressive chemicals** and **easy to clean**.

Housing

The **die-cast case with high-quality insulation** ensures **user safety** during operation at high temperatures. The **minimized heat transfer** from the plate to the inside also ensures a **longer life time**.

Temperature control & safety

Two independent internal temperature sensors assure accurate temperature control and prevent from malfunction or danger caused by overheating.

Accessories

The **external temperature sensor** allows accurate temperature due to digital feedback control system.

Motor

The **brushless shade motor** ensures strong and precise stirring, **minimized noise** and a **long life time**. Due to the high-performance magnet, up to 20 l of water can be stirred easily.

Safety first

Hot top indicator lamp illuminates when temperature on the plate is over 50°C.

Controller

New **Jog-Dial “Turn + Push”** and touch button are designed for **intuitive, easy and direct use**.



Magnetic stirrer with hotplate

digital, up to 500°C, 80-1,500 rpm, solid ceramic plate 200x200 mm

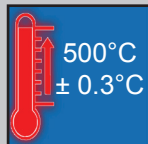
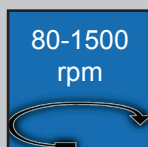

MSH-500 Set

Stirrer bar included

MSH-500 digital, 500°C

Ideal for:

- mixing of chemical, laboratory and pharmaceutical materials
- heat-sensitive procedures in microbiology and biochemistry
- sample drying and general lab heating applications where high temperature is needed

Features:

- new design: lighter and more compact than the previous model
- digital display with backlight
- high-quality solid ceramic plate 200x200 mm, up to 500°C
- heat-, chemical- and acid-resistant
- brushless shade motor for 80-1,500 rpm
- enormous strength of magnet
- perfect heat uniformity from the inner to the edge
- no liquid can get into the body
- powder-coated aluminium body
- 30 mm stirrer bar included
- CE certified and unique serial number for tracing

Safety mechanism:

- hot top indicator lamp
- ideal fourfold insulation: BTU, ceramic paper and 2 x SUS
- timer 99h 59min with timer-end signal
- error status and locking mode
- operation LEDs

Controller:

- **Jog-Dial** controller with touch-button for precise temperature control

Model	MSH-500
Body	powder-coated aluminium
Plate	solid ceramic plate, 200x200 mm
Stirring capacity	max. 20 l
Speed & control resolution	80 - 1,500 rpm, 5 rpm
Temperature range & accuracy	max. 500°C, ±0.3°C
Temperature resolution	0.1°C display, 0.5°C control
Temperature uniformity	specialy designed heating module: temperature difference less than 10%
Heating power / consumption	850W
Timer & alarm	99hr 59min (with continuous run), error status and timer-end
Display	digital LCD with backlight function
Controller	digital feedback controller with Jog-Dial (Turn+Push) and Touch-button
Safety circuit	overheat protection, hot top indicator LED lamp
Stirring bar	30 mm bar included, usable up to 50 mm bar
Permissible temperature & RH %	ambient temperature +5 ~ 50°C, 85% RH
Dimension & weight	220 x 332 x 144, 3.8 kg
Power supply	1 Phase AC 120V, 60 Hz or AC 230V, 50/60 Hz
Order number 230V	Set: DH.WMH00500 Unit: DH.WMH01500
Order number 120V	Set: DH.WMH00501 Unit: DH.WMH01501

Set includes: Unit MSH-500
 Temperature probe Ø4xL250 mm, cable length: 190 mm
 Stand rod Ø12xL450 mm with thread, stainless steel
 Holder / clamp / clip for fixation of temperature probe

Accessories: External temperature probes, stand rod, stirring bars and holder / clamp / clip on page 27

Magnetic stirrer with hotplate

digital, up to 500°C, 80-1,500 rpm, solid ceramic plate 200x200 mm

80-1500
rpm



500°C
± 0.3°C

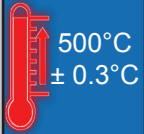

MSH-500D Set

Stirrer bar included

MSH-500D digital, 500°C

Ideal for:

- mixing of chemical, laboratory and pharmaceutical materials
- heat-sensitive procedures in microbiology and biochemistry
- sample drying and general lab heating applications where high temperature is needed

Features:

- up to 500°C
- digital display with backlight
- high-quality solid ceramic plate 200x200 mm
- heat-, chemical- and acid-resistant
- brushless shade motor for 80-1,500 rpm
- enormous strength of magnet
- perfect heat uniformity from the inner to the edge
- no liquid can get into the body
- powder-coated aluminium body
- 30 mm stirrer bar included
- CE certified and unique serial number for tracing

Safety mechanism:

- hot top indicator lamp
- high quality insulation (BTU)
- timer 99h 59min with timer-end signal
- error status and locking mode
- operation LEDs

Controller:

- **Jog-Dial** controller with touch-button for precise temperature control

Model	MSH-500D
Body	powder-coated aluminium
Plate	solid ceramic plate, 200x200 mm
Stirring capacity	max. 20 l
Speed & control resolution	80 ~ 1,500 rpm, 5 rpm
Temperature range & accuracy	max. 500°C, ±0.3°C
Temperature resolution	0.1°C display, 0.5°C control
Temperature uniformity	specially designed heating module: temperature difference less than 10%
Heating power / consumption	850W
Timer & alarm	99hr 59min (with continuous run), error status and timer-end
Display	digital LCD with backlight function
Controller	digital feedback controller with Jog-Dial (Turn+Push) and Touch-button
Safety circuit	overheat protection, hot top indicator LED lamp
Stirring bar	30 mm bar included, usable up to 50 mm bar
Permissible temperature & RH %	ambient temperature +5 ~ 50°C, 85% RH
Dimension & weight	205x345xh135 mm, 3.3 kg
Packaging size	400x280xh160 mm, unit: 5.4 kg, set: 6.0 kg
Power supply	1 Phase AC 120V, 60 Hz or AC 230V, 50/60 Hz
Order number 230V	Unit: DH.WMH05020 Set: DH.WMH04020
Order number 120V	Unit: DH.WMH05021 Set: DH.WMH04021

Set includes: Unit MSH-500D
 Temperature probe Ø4xL250 mm, cable length: 190 mm
 Stand rod Ø12xL450 mm with thread, stainless steel
 Holder / clamp / clip for fixation of temperature probe

Accessories: External temperature probes, stand rod, stirring bars and holder / clamp / clip on page 27

Magnetic stirrer with hotplate

digital, up to 380°C, 80-1,500 rpm, ceramic-coated square-type plate



MSH-D square-type, digital, 380°C

Ideal for:

- mixing of chemical, laboratory and pharmaceutical materials
- heat-sensitive procedures in microbiology and biochemistry
- sample drying and general lab heating applications

Features:

- up to 380°C
- shade motor for 80-1,500 rpm
- digital display with backlight
- ceramic-coated aluminium plate 180x180 / 260x260 mm
- heat-, chemical- and restricted acid-resistant
- no liquid can get into the body
- powder-coated body
- easy to clean
- 30 mm stirrer bar included
- CE certified and unique serial number for tracing

Safety mechanism:

- timer 99h 59min with timer-end signal
- error status
- locking mode
- operation LEDs

Controller:

- **Jog-Shuttle** controller with touch-button

Model	MSH-20D	MSH-30D
Body	powder-coated aluminium	powder-coated steel
Plate	ceramic-coated aluminium 180x180 mm	ceramic-coated aluminium 260x260 mm
Stirring capacity	max. 20 l	
Speed & control resolution	80 ~ 1,500 rpm, 5 rpm	
Temperature range & accuracy	max. 380°C, ±0.3°C	
Temperature resolution	0.1°C display, 0.5°C control	
Temperature uniformity	specially designed heating module: temperature difference less than 10%	
Heating power / consumption	600W	1.2kW
Timer & alarm	99hr 59min (with continuous run), error status and timer-end	
Display	digital LCD with backlight function	
Controller	digital feedback controller with Jog-Dial (Turn+Push) and touch button	
Safety circuit	overheat protection	
Stirring bar	30 mm bar included, usable up to 50 mm bar	
Permissible temperature & RH %	ambient temperature +5 ~ 50°C, 85% RH	
Dimension & weight	206x307xh99 mm, 3.3 kg	286x387xh99 mm, 3.5 kg
Packaging size	400x280xh200 mm, 5 kg	430x320xh200 mm, 5 kg
Power supply	1 Phase AC 120V, 60 Hz or AC 230V, 50/60 Hz	
Order number 230V	Unit: DH.WMH03020 Set: DH.WMH03021	Unit: DH.WMH03022 Set: DH.WMH03023
Order number 120V	Unit: DH.WMH02020 Set: DH.WMH02021	Unit: DH.WMH02022 Set: DH.WMH02023

Accessories: External temperature probes, stand rod, stirring bars and holder / clamp / clip on page 27

Magnetic stirrer with hotplate

analog, up to 380°C, up to 1,500 rpm, ceramic-coated square-type plate

up to 1500 rpm



380°C
± 0.3°C

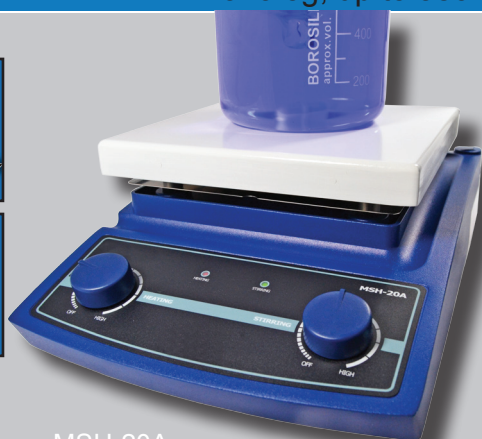
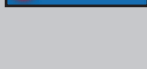

MSH-20A



MSH-30A



Stirrer bar included

MSH-A square-type, analog, 380°C

Ideal for:

- mixing of chemical, laboratory and pharmaceutical materials
- heat-sensitive procedures in microbiology and biochemistry
- sample drying and general lab heating applications

Features:

- up to 380°C
- up to 1,500 rpm
- ceramic-coated aluminium plate 180x180 / 260x260 mm
- heat-, chemical- and restricted acid-resistant
- no liquid can get into the body
- powder-coated body
- easy to clean
- 30 mm stirrer bar included
- CE certified and unique serial number for tracing

Safety mechanism:

- operation LEDs

Controller:

- **PWM controller**

Model	MSH-20A	MSH-30A
Body	powder-coated aluminium	powder-coated steel
Plate	ceramic-coated aluminium 180x180 mm	ceramic-coated aluminium 260x260 mm
Stirring capacity	max. 20 l	
Speed & control resolution	up to 1,500 rpm	
Temperature range & accuracy	max. 380°C	
Temperature uniformity	specially designed heating module: temperature difference less than 10%	
Heating power / consumption	600W	1.2kW
Controller	superior linearity PWM Controller	
Stirring bar	30 mm bar included, usable up to 50 mm bar	
Permissible temperature & RH %	ambient temperature +5 ~ 50°C, 85% RH	
Dimension & weight	206x307xh99 mm, 2.8 kg	286x387xh99 mm, 3.3 kg
Packaging size	400x280xh200 mm, 5 kg	430x320xh200 mm, 5 kg
Power supply	1 Phase AC 120V, 60 Hz or AC 230V, 50/60 Hz	
Order number 230V	DH.WMH03120	DH.WMH03121
Order number 120V	DH.WMH02120	DH.WMH02121

Accessories: Stirring bars on page 28

Magnetic stirrer with hotplate

analog, multiple places (3 & 6), up to 350°C, 80-1,500 rpm, ceramic-coated plates 140x140 mm

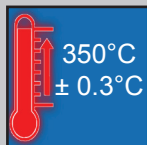
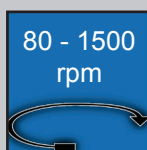

Stirrer bar included



SMHS-3

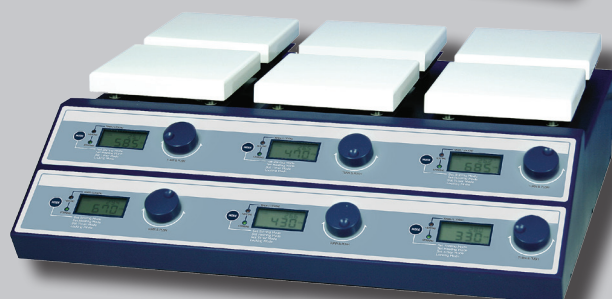

SMHS-6

SMHS multi-type, digital, 350°C

Ideal for:

- multiple mixing and heating applications at the same time
- mixing of chemical, laboratory and pharmaceutical materials
- heat-sensitive procedures in microbiology and biochemistry
- sample drying and general lab heating applications

Features:

- each place individually adjustable
- digital Jog-Dial controller for each place
- up to 350°C
- up to 1,500 rpm
- ceramic-coated aluminium plate with 3 or 6 places 140x140 mm
- heat-, chemical- and restricted acid-resistant
- no liquid can get into the body
- powder-coated steel body
- easy to clean
- 30 mm stirrer bar included (3x / 6x)
- up to 3 temperature probes possible (3 & 6 place-type)
- CE certified and unique serial number for tracing

Safety mechanism:

- timer 99h 59min with timer-end signal
- error status
- locking mode
- operation LEDs

Controller:

- **Jog-Dial** controller with touch-button

Model	SMHS-3	SMHS-6
Stirring points	3	6 (2x3)
Body	powder-coated steel	
Plate	ceramic-coated aluminium 140x140 mm (each place)	
Stirring capacity	max. 20 l	
Speed & control resolution	80 ~ 1,500 rpm, 5 rpm	
Temperature range & accuracy	max. 350°C, ±0.3°C	
Temperature resolution	0.1°C display, 0.5°C control	
Temperature uniformity	specially designed heating module: temperature difference less than 10%	
Heating power / consumption	400W x3	400W x6
Timer & alarm	99hr 59min (with continuous run), error status and timer-end	
Display	digital LCD with backlight function	
Controller	digital feedback controller with Jog-Dial (Turn+Push) and touch-button	
Safety circuit	overheat protection	
Stirring bar	3x/6x 30 mm bar included, usable up to 50 mm bar	
Permissible temperature & RH %	ambient temperature +5 ~ 50°C, 85% RH	
Temperature sensor ports	3	3
Stand rod sockets	3	6
Dimension & weight	510x240xh100 mm, 10 kg	510x410xh180 mm, 18 kg
Packaging size	540x330xh170 mm, 10 kg	570x540xh230 mm, 18 kg
Power supply	1 Phase AC 120V, 60 Hz or AC 230V, 50/60 Hz	
Order number 230V	DH.WMH03503	DH.WMH03506
Order number 120V	DH.WMH02503	DH.WMH02506

Accessories: External temperature probes, stand rod, stirring bars and holder / clamp / clip on page 27 & 28

Magnetic stirrer with hotplate | Hotplate

Accessories: external temperature probe, stand rods, holder/clamp/clip

Temperature probes for hotplates and magnetic stirrer with hotplate

For device(s)	Design	Measurements	Article	Order number
HP-500D MSH-500D MSH-50D HP-20D HP-30D MSH-20D MSH-30D SMHS	Standard	Ø4xL250 mm, cable: 190 mm	SS500	DH.WHP503060
HP-500D MSH-500D MSH-50D HP-20D HP-30D MSH-20D MSH-30D SMHS	PTFE-coated	Ø4xL250 mm, cable: 190 mm	SS510	DH.WHP503061



Stand rods for hotplates and magnetic stirrer with hotplate

For device(s)	Design	Measurements	Article	Order number
HP-30A, HP-30D MSH-30A, MSH-30D	without thread	Ø12.7xh450 mm	RD100	DH.WHP503011
HP-20A, HP-20D, HP-500D MSH-20A, MSH-20D MSH-50A, MSH-50D MSH-500D, SMHS	with thread	Ø12xh450 mm	RD200	DH.WHP503036



Holder, clamp and clip suitable for stand rods RD100 and RD200

For device(s)	Article	Order number
all hotplates and magnetic stirrer with hotplate	CL220	DH.WHP503012

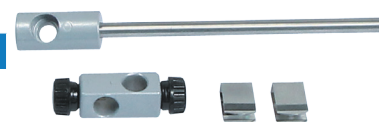

Magnetic stirrer with hotplate

Accessories: magnet stirrer bars

Magnetic stirrer bar

- cylindrical
- PTFE
- with permanent magnet



Ø x Length	Order number
Ø 3 x 6 mm	7 211 001
Ø 3 x 8 mm	7 211 002
Ø 4.5 x 12 mm	7 211 003
Ø 4.5 x 15 mm	7 211 004
Ø 6 x 20 mm	7 211 005
Ø 6 x 25 mm	7 211 006
Ø 6 x 30 mm	7 211 007
Ø 6 x 35 mm	7 211 008
Ø 8 x 40 mm	7 211 009
Ø 8 x 45 mm	7 211 010
Ø 8 x 50 mm	7 211 011
Ø 9 x 60 mm	7 211 012
Ø 9 x 70 mm	7 211 013
Ø 10 x 80 mm	7 211 014

Magnetic stirrer bar

- cylindrical with ring
- PTFE
- with permanent magnet



Ø x Length	Order number
Ø 3 x 8 mm	7 212 001
Ø 5 x 12 mm	7 212 002
Ø 5 x 15 mm	7 212 003
Ø 6 x 20 mm	7 212 004
Ø 6 x 25 mm	7 212 005
Ø 6 x 30 mm	7 212 006
Ø 6 x 35 mm	7 212 007
Ø 7 x 40 mm	7 212 008
Ø 8 x 45 mm	7 212 009
Ø 8 x 50 mm	7 212 010
Ø 9 x 60 mm	7 212 011
Ø 9 x 70 mm	7 212 012

Magnetic stirrer bar set

- 13 different bars + 1 bar retriever (Ø 10 x 150 mm)
- PTFE
- with permanent magnet

Ø x Length	Shape	Order number
Ø 10 x 6 mm	cylindrical	7 213 112
Ø 4.5 x 15 mm		
Ø 6 x 20 mm		
Ø 6 x 25 mm		
Ø 6 x 30 mm		
Ø 8 x 40 mm		
Ø 8 x 50 mm		
Ø 9 x 60 mm		
Ø 4.5 x 15 mm	cylindrical with ring	
Ø 6 x 25 mm		
Ø 8 x 40 mm		
Ø 8 x 25 mm	oval	
Ø 14 x 40 mm		

Magnetic stirrer bar

- oval (especially for round bottom flasks)
- PTFE
- with permanent magnet



Ø x Length	Order number
Ø 10.5 x 20 mm	7 214 001
Ø 12 x 25 mm	7 214 002
Ø 15 x 30 mm	7 214 003
Ø 15 x 35 mm	7 214 004
Ø 20 x 40 mm	7 214 005
Ø 20 x 50 mm	7 214 006
Ø 20 x 65 mm	7 214 007
Ø 20 x 71 mm	7 214 008

Magnetic stirrer bar

- triangular
- PTFE
- with permanent magnet



Ø x Length	Order number
Ø 8 x 12 mm	7 213 001
Ø 8 x 25 mm	7 213 002
Ø 10 x 35 mm	7 213 003
Ø 12 x 50 mm	7 213 004

Magnetic stirrer bar

- cylindrical
- borosilicate glass coated
- with permanent magnet



Ø x Length	Order number
Ø 8 x 20 mm	7 211 019 G
Ø 8 x 25 mm	7 211 020 G
Ø 10 x 30 mm	7 211 021 G
Ø 12 x 40 mm	7 211 009 G

Magnetic stirrer bar retrievers

- magnet only at one end
- PTFE

Ø x Length	Order number
Ø 10 x 150 mm	7 218 001
Ø 10 x 250 mm	7 218 002
Ø 10 x 300 mm	7 218 003
Ø 10 x 350 mm	7 218 004
Ø 10 x 400 mm	7 218 005

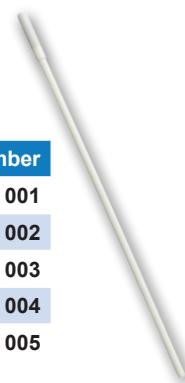

Magnetic stirrer with hotplate | Hotplate

Accessories: beaker with rim for round-type magnetic stirrer MSH-50A and MSH-50D

Safety beaker with rim, handle and spout

For device(s)	Design	Order number
MSH-50A, MSH-50D	Ø145 mm	5 500 314
other brands	Ø165 mm	5 500 316



Energy saving

- absolute plane (flat) bottom (Ø145 mm and Ø165 mm)
- up to 30% faster
- more effective therefore more cost effective heating / stirring performance

Safety

- solid non-slipping bottom rim covering the plate
- strong handle for easy and safe moving of the beaker
- produced of heat resistant Borosilicate glass 3.3
- the plane bottom ensures the steady and silent movement of the magnetic stirring bar

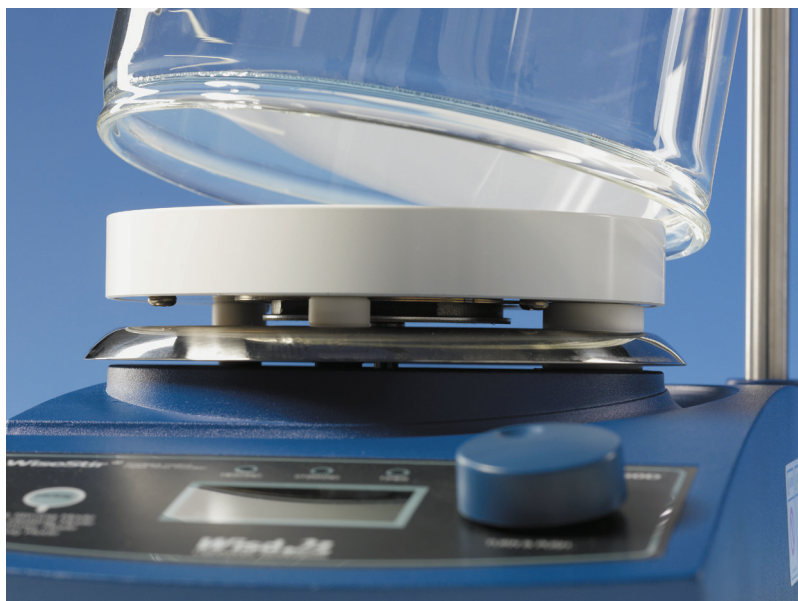

The stirring beakers match with all common hotplates and magnetic stirrers with round stirring plate Ø145 mm and Ø165 mm (such as from witeg®, IKA®, Heidolph®, CAT® etc.)

Dry bath

compact design, 1-block-model, up to 150°C, various blocks available

NEW

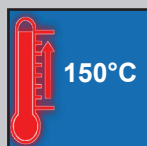

H-20 up to 150°C

Ideal for:

- enzyme reactions, inactivation of sera, incubation and other laboratory procedures
- multifunctional dry block heater

Features:

- new design: lighter and more compact than the previous model
- user's self-compensation function to offset between real temperature and indicated temperature ($\pm 10.0^\circ\text{C}$)
- ergonomic, compact design & modular block system
- internal PPS bath ensures best insulation, block made from anodized aluminium
- precise temperature control
- digital timer with delay time and operation time
- convenient integrated timer for time-sensitive incubations
- block removal tool with screw thread included
- storage function for the set values of temperature and timer
- various block types (optional)
- backlight LCD display
- CE certified and unique serial number for tracing

Safety mechanism:

- locking mode
- overheat and over-current protection
- sensor error detection

Controller:

- digital fuzzy controller with **Jog-Dial** and **main touch button**

H-20 set with block and block removal tool

Model	H-20	
Block	interchangeable block (90 x 120 x 60 mm) for various tubes	
Standard block	-	2x 48 holes for 1.5/2 ml centrifuge tubes
Temperature range and Accuracy	ambient to $+5^\circ\text{C}$ to 150°C , ± 0.1 at 37°C , $\pm 0.2^\circ\text{C}$ at 90°C , $\pm 0.4^\circ\text{C}$ at 135°C	
Heat up speed & sensor	approx. $5^\circ\text{C}/\text{min}$, PT100	
Timer with alarm	99hr 59min, alarm (error status and timer end)	
Dimension	unit: 178 x 226 x 138 mm, block: 90 x 120 x 60 mm	
Packing size	230 x 290 x 245 mm, 2.2 kg	230 x 355 x 245 mm, 3.5 kg
Power supply	1 Phase AC 120V, 60 Hz or AC 230V, 50/60Hz	
Power consumption	300 W	
Order number 230V	Unit: DH.WHB02000	Set: DH.WHB02100
Order number 120V	Unit: DH.WHB02001	Set: DH.WHB02101

Set includes: Unit
Block
Block removal tool

H-20
BLC548 for 48x 1.5/2 ml tubes

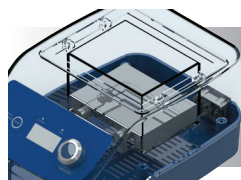

High quality molded heater ensures reliable and consistent temperature

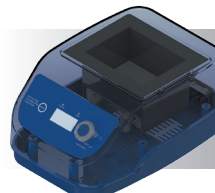

Maximum heat insulation and highest chemical resistance by PPS materials

Accessories: Dry bath blocks and removal tool on page 33

Dry bath

two blocks, individual controller for each block, up to 150°C, various blocks available

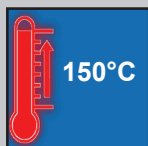

HB-96D 2 blocks up to 150°C

Ideal for:

- enzyme reactions, inactivation of sera, incubation and other laboratory procedures
- multifunctional dry block heater

Features:

- user's self-compensation function to offset between real temperature and indicated temperature ($\pm 10.0^{\circ}\text{C}$)
- unit made of stainless steel and powder-coated steel, block made of anodized aluminium
- digital timer function
- block extraction tongs "BLE101" & block cover are included
- storage function for the set values of temperature and timer
- alarm function: error status and timer end
- various kinds of blocks are offered (optional)
- dual block and 2 molded heater (300W)
- backlight LCD display
- CE certified and unique serial number for tracing

Safety mechanism:

- locking mode
- overheat and over-current protection
- sensor error detection

Controller:

- dual digital fuzzy controller with *Jog-Shuttle-switch*



HB-96D Set with blocks and tong

Model	HB-96D	
Block	interchangeable block (90 x 120 x 60 mm) for various tubes	
Standard block	-	2x 48 holes for 1.5/2 ml centrifuge tubes
Temperature range and Accuracy	ambient to $+5^{\circ}\text{C}$ to 150°C , ± 0.1 at 37°C , $\pm 0.2^{\circ}\text{C}$ at 90°C , $\pm 0.4^{\circ}\text{C}$ at 135°C	
Heat up speed & sensor	approx. $5^{\circ}\text{C}/\text{min}$ PT 100	
Timer with alarm	99hr 59min, alarm (error status and timer end)	
Dimension	unit: 285 x 250 x 155 mm, 2 x block: 90 x 120 x 60 mm	
Packing size	400 x 270 x 200 mm, 6 kg	
Power supply	1 Phase AC 120V, 60 Hz or AC 230V, 50/60Hz	
Power consumption	600 W	
Order number 230V	Unit: DH.WHB00198	Set: DH.WHB00199
Order number 120V	Unit: DH.WHB02198	Set: DH.WHB02199

Set includes: Unit HB-96D
Block 2x BLC548 for 48x 1.5/2 ml tubes
Tong BLE101

Accessories: Dry bath blocks and tong on page 33

Dry bath

one block, -5°C up to 95°C, various blocks available



HB-R48 -5°C up to 95°C

Ideal for:

- enzyme reactions, inactivation of sera, incubation and other laboratory procedures

Features:

- user's self-compensation function to offset between real temperature and indicated temperature ($\pm 10.0^\circ\text{C}$)
- 2 peltier cooling modules
- unit made of stainless steel and powder-coated steel, block made of anodized aluminium
- block extraction tongs "BLE101" and block cover are included
- molded heater (300W), PT100 sensor
- storage function for the set values of temperature and timer
- backlight LCD display
- CE certified and unique serial number for tracing

Safety mechanism:

- locking mode
- overheat and over-current protection
- sensor error detection

Controller:

- digital PID and fuzzy controller with *Jog-Shuttle-switch*



HB-R48 Set with block and tong

Model	HB-R48	
Block	interchangeable block (90 x 120 x 60 mm) for various tubes	
Standard block	-	48 holes for 1.5/2 ml centrifuge tubes
Temperature range and accuracy	ambient to -5°C to 95°C, ± 0.1 at 37°C, $\pm 0.2^\circ\text{C}$ at 90°C	
Cool-down speed	2.3°C/min. between 95°C to 25°C, 0.5°C/min between 25°C to -5°C	
Heat-up speed	approx. 5°C/min	
Timer with alarm	99hr 59min, alarm (error status and timer end)	
Dimension	unit: 185 x 230 x 220 mm, block: 90 x 120 x 60 mm	
Packing size	350 x 220 x 310 mm, 9 kg	
Power supply	1 Phase AC 120V, 60 Hz or AC 230V, 50/60Hz	
Power consumption	450 W	
Order number 230V	Unit: DH.WHB00248	Set: DH.WHB00249
Order number 120V	Unit: DH.WHB02248	Set: DH.WHB02249

Set includes: Unit HB-R48
Block BLC548 for 48x 1.5/2 ml tubes
Tong BLE101

Accessories: Dry bath blocks and tong on page 33

Blocks for dry baths

- anodized aluminium
- 90 x 120 x h60 mm



For	0.2 ml PCR tubes	0.5 ml PCR tubes	1.5/2 ml tubes	Ø12 mm tubes	Ø13 mm tubes
Holes	96 holes Ø: 6 mm depth: 15.5 mm conical bottom	63 holes Ø: 7.7 mm depth: 29.5 mm conical bottom	48 holes Ø: 11 mm depth: 36 mm conical bottom	48 holes Ø: 12 mm depth: 35 mm round bottom	30 holes Ø: 13 mm depth: 47 mm round bottom
Article	BLC596	BLC570	BLC548	BLT248	BLT335
Order number	DH.WHB510596	DH.WHB510570	DH.WHB511548	DH.WHB521248	DH.WHB521335



For	Ø15 mm tubes	Ø16.5 mm tubes	Ø18 mm tubes	15 ml conical tubes	50 ml conical tubes
Holes	30 holes Ø: 15 mm depth: 47 mm round bottom	24 holes Ø: 16.5 mm depth: 47 mm round bottom	24 holes Ø: 18 mm depth: 47 mm round bottom	15 holes Ø: 16 mm depth: 47 mm conical bottom	8 holes Ø: 28.7 mm depth: 47 mm conical bottom
Article	BLT535	BLT628	BLT828	BLC515	BLC008
Order number	DH.WHB521535	DH.WHB521628	DH.WHB521828	DH.WHB531515	DH.WHB535008

Block removal tool with screw thread, for adding and removing blocks

Order number

DH.WHB500102

NEW



Tong, for adding and removing blocks

Article

BLE101

Order number

DH.WHB500101



Heating mantle | beaker

for beaker, integrated controller, 100°C - 450°C

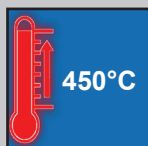

WHM for beaker, 100°C - 450°C integrated controller

Ideal for:

- for beaker 100 - 5,000 ml

Features:

- 100°C - 450°C
- full choice of vessel, capacity, housing and control are offered
- nickel chrome heating element
- coil type: acid-resistant, long life time
- all kinds of beaker can be used (Duran®/Kimax/Pyrex/Iwaki)
- CE certified and unique serial number for tracing

Controller:

- built-in *temperature controller*

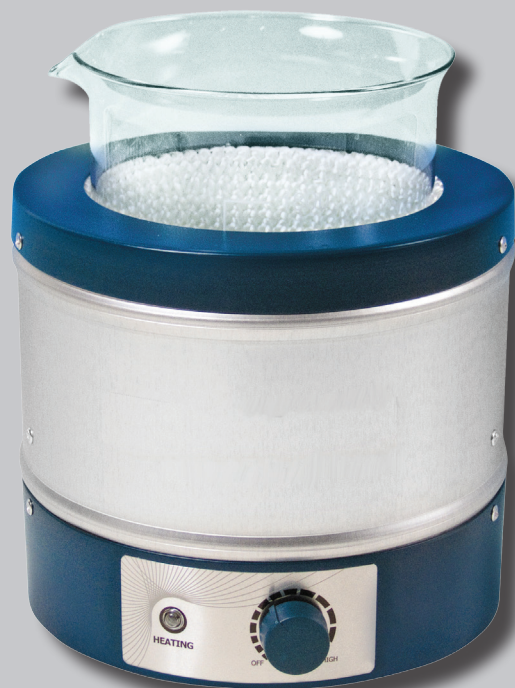

1.000 ml beaker heating mantle

Application (beaker brand)	Beaker capacity (ml)	Beaker Ø (mm)	Watts (W)	Inside depth (mm)	Mantle outside Ø x H mm	Support rod Ø x H mm	Order number
							with 230V
common-use	100	50 - 52	80	40	Ø 145 x 105	Ø 13 x 440	DH.WHM12141
common-use	250	68 - 70	140	65	Ø 145 x 140	Ø 13 x 440	DH.WHM12142
for DU.	400	79 - 81	240	70	Ø 145 x 140	Ø 13 x 440	DH.WHM12143
for Iw./Ki./Py.	400	76 - 78	240	75	Ø 145 x 140	Ø 13 x 440	DH.WHM121431
common-use	600	88 - 90	240	75	Ø 145 x 140	Ø 13 x 440	DH.WHM12144
common-use	800	98 - 100	300	90	Ø 190 x 165	Ø 13 x 440	DH.WHM12145
common-use	1,000	105 - 108	350	90	Ø 190 x 165	Ø 13 x 440	DH.WHM12146
common-use	2,000	130 - 132	450	125	Ø 190 x 180	Ø 13 x 660	DH.WHM12147
for DU./Iw.	3,000	151 - 153	550	160	Ø 270 x 235	Ø 13 x 660	DH.WHM12148
for Ki./Py.	4,000	160 - 162	700	160	Ø 270 x 235	Ø 13 x 660	DH.WHM121481
for DU.	5,000	169 - 171	800	160	Ø 270 x 235	Ø 13 x 660	DH.WHM12149

Remarks: DU. = Duran®, Ki. = Kimax, Iw. = Iwaki, Py. = Pyrex

Heating mantle | beaker

for beaker, integrated magnetic stirrer and controller, up to 450°C

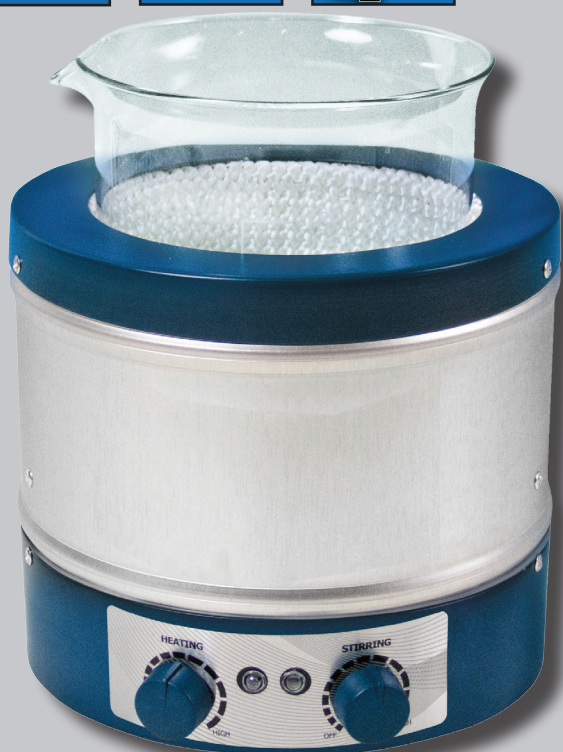
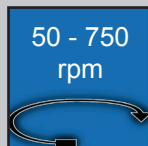
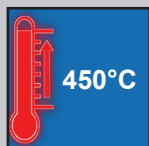

1.000 ml beaker heating mantle

WHM for beaker, 100°C - 450°C with built-in magnetic stirrer integrated controller

Ideal for:

- for beaker 100 - 5,000 ml

Features:

- 100°C - 450°C
- built-in stirring and temperature controller
- 50 ~ 750 rpm
- full choice of vessel, capacity, housing and control are offered
- nickel chrome heating element
- coil type: acid-resistant, long life time
- all kinds of beaker can be used (Duran®/Kimax/Pyrex/Iwaki)
- CE certified and unique serial number for tracing

Controller:

- built-in *stirring & temperature controller*



2x stirrer bars included

Application (beaker brand)	Beaker capacity (ml)	Beaker Ø (mm)	Watts (W)	Inside depth (mm)	Mantle outside Ø x H mm	Support rod Ø x H mm	Order number
							with 230V
common-use	100	50 - 52	80	45	Ø 145 x 140	Ø 13 x 440	DH.WHM121601
common-use	250	68 - 70	140	70	Ø 190 x 165	Ø 13 x 440	DH.WHM121602
for DU.	400	79 - 81	240	70	Ø 190 x 165	Ø 13 x 440	DH.WHM121603
for Iw./Ki./Py.	400	76 - 78	240	70	Ø 190 x 165	Ø 13 x 440	DH.WHM121604
common-use	600	88 - 90	240	72	Ø 190 x 165	Ø 13 x 440	DH.WHM121605
common-use	1,000	105 - 108	350	90	Ø 190 x 200	Ø 13 x 440	DH.WHM121606
common-use	2,000	130 - 132	450	140	Ø 270 x 235	Ø 13 x 660	DH.WHM121607
for DU./Iw.	3,000	151 - 153	550	140	Ø 270 x 235	Ø 13 x 660	DH.WHM121608
for Ki./Py.	4,000	160 - 162	700	170	Ø 325 x 270	Ø 13 x 660	DH.WHM121609
for DU.	5,000	169 - 171	800	170	Ø 325 x 270	Ø 13 x 660	DH.WHM121610

Remarks: DU. = Duran®, Ki. = Kimax, Iw. = Iwaki, Py. = Pyrex

Accessories: Magnetic stirrer bars can be found on page 28

Heating mantle | beaker

for beaker, external controller available, up to 450°C

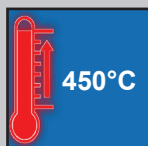

WHM for beaker, 450°C for use with external controller

Ideal for:

- for beaker 100 - 5,000 ml and use with magnetic stirrer

Features:

- highly processed aluminium case offers robust standing, easy handling and usability on the magnetic stirrer
- k-type thermo sensor is basically embedded
- nickel chrome heating element
- coil type: acid-resistant, long life time
- CE certified and unique serial number for tracing

Controller:

- optional remote thermo controllers are available (analog: WHM-C10A, digital: WHM-C10D)



600 ml beaker heating mantle



WHM-C10D
digital controller



WHM-C10A
analog controller

Application (beaker brand)	Beaker capacity (ml)	Beaker Ø (mm)	Watts (W)	Inside depth (mm)	Mantle outside Ø x H mm	Support rod Ø x H mm	Order number
							with 230V
common-use	100	50 - 52	80	50	Ø 145 x 75	Ø 13 x 440	DH.WHM12170
common-use	250	68 - 70	140	50	Ø 145 x 75	Ø 13 x 440	DH.WHM12171
for DU.	400	79 - 81	240	85	Ø 145 x 110	Ø 13 x 440	DH.WHM12172
for lw./Ki./Py.	400	76 - 78	240	85	Ø 145 x 110	Ø 13 x 440	DH.WHM121721
common-use	600	88 - 90	240	85	Ø 145 x 110	Ø 13 x 440	DH.WHM12173
common-use	800	98 - 100	300	90	Ø 190 x 190	Ø 13 x 440	DH.WHM12174
common-use	1,000	105 - 108	350	115	Ø 190 x 165	Ø 13 x 440	DH.WHM12175
common-use	2,000	130 - 132	450	140	Ø 190 x 160	Ø 13 x 660	DH.WHM12176
for DU./lw.	3,000	151 - 153	550	175	Ø 270 x 200	Ø 13 x 660	DH.WHM12177
for Ki./Py.	4,000	160 - 162	700	175	Ø 270 x 200	Ø 13 x 660	DH.WHM12178
for DU.	5,000	169 - 171	800	175	Ø 270 x 200	Ø 13 x 660	DH.WHM12179
for DU.	10,000 *	216 - 219	1400	245	Ø 325 x 270	Ø 13 x 660	DH.WHM121791

* 10,000 ml mantle steel case - magnetic stirring is not available

Remarks: DU. = Duran®, Ki. = Kimax, lw. = lwaki, Py. = Pyrex

Accessories: Remote controller and temperature probes on page 46

Heating mantle | round flasks

for spherical flasks, integrated controller, up to 450°C

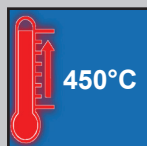

450°C

flask



1.000 ml round flask heating mantle

WHM for round flasks, 100°C-450°C integrated controller

Ideal for:

- spherical flasks 50 - 20,000 ml

Features:

- full choice of vessel, capacity, housing and control are offered
- nickel chrome heating element
- coil type: acid-resistant, long life time
- all kinds of round flasks can be used (Duran®/Kimax/Pyrex/Iwaki)
- CE certified and unique serial number for tracing

Controller:

- built-in *temperature controller*

Application (flask brand)	Flask capacity (ml)	Flask Ø (mm)	Watts (W)	Inside depth (mm)	Mantle outside Ø x H mm	Support rod Ø x H mm	Order number	
							with 230V	with 120V
common-use	50	49 - 52	80	40	Ø 145 x 140	Ø 13 x 440	DH.WHM12010	DH.WHM12020
common-use	100	63 - 66	80	40	Ø 145 x 140	Ø 13 x 440	DH.WHM12011	DH.WHM12021
common-use	250	83 - 86	140	50	Ø 145 x 140	Ø 13 x 440	DH.WHM12012	DH.WHM12022
common-use	500	102 - 105	240	65	Ø 190 x 165	Ø 13 x 440	DH.WHM12013	DH.WHM12023
common-use	1,000	130 - 133	350	75	Ø 190 x 165	Ø 13 x 440	DH.WHM12014	DH.WHM12024
for DU./Iw.	2,000	165 - 169	450	100	Ø 270 x 200	Ø 13 x 660	DH.WHM12015	DH.WHM12025
for Ki./Py.	2,000	161 - 164	450	100	Ø 270 x 200	Ø 13 x 660	DH.WHM120151	DH.WHM120251
for DU./Ki.	3,000	184 - 187	550	105	Ø 270 x 200	Ø 13 x 660	DH.WHM12016	DH.WHM12026
common-use	5,000	221 - 224	800	131	Ø 325 x 226	Ø 13 x 800	DH.WHM12017	DH.WHM12027
for DU./Ki.	6,000	234 - 237	800	131	Ø 325 x 226	Ø 13 x 800	DH.WHM12018	DH.WHM12028
for DU.	10,000*	278 - 282	1400	150	Ø 390 x 240	Ø 13 x 800	DH.WHM12019	DH.WHM12029
for DU.	20,000*	344 - 348	2000	200	Ø 470 x 260	Ø 13 x 800	DH.WHM12070	DH.WHM12071

*-marks: 10,000 ml & 20,000 ml mantle steel case - magnetic stirring is not available
Remarks: DU. = Duran®, Ki. = Kimax, Iw. = Iwaki, Py. = Pyrex

Heating mantle | round flasks

for spherical flasks, integrated magnetic stirrer and controller, up to 450°C

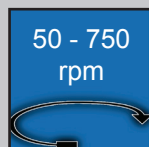
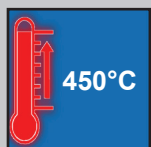

1.000 ml round flask heating mantle

WHM for round flasks, 100°C-450°C with built-in magnetic stirrer integrated controller

Ideal for:

- spherical flasks 50 - 6,000 ml

Features:

- full choice of vessel, capacity, housing and control are offered
- nickel chrome heating element
- coil type: acid-resistant, long life time
- built-in temperature controller
- all kinds of round flasks can be used (Duran®/Kimax/Pyrex/Iwaki)
- CE certified and unique serial number for tracing

Controller:

- built-in *stirring and temperature controller*



2x stirrer bars included

Application (flask brand)	Flask capacity (ml)	Flask Ø (mm)	Watts (W)	Inside depth (mm)	Mantle outside Ø x H mm	Support rod Ø x H mm	Order number	
							with 230V	with 120V
common-use	50	49 - 52	80	40	Ø 145 x 140	Ø 13 x 440	DH.WHM12030	DH.WHM12040
common-use	100	63 - 66	80	40	Ø 145 x 140	Ø 13 x 440	DH.WHM12031	DH.WHM12041
common-use	250	83 - 86	140	50	Ø 145 x 140	Ø 13 x 440	DH.WHM12032	DH.WHM12042
common-use	500	102 - 105	240	65	Ø 190 x 165	Ø 13 x 440	DH.WHM12033	DH.WHM12043
common-use	1,000	130 - 133	350	75	Ø 190 x 190	Ø 13 x 440	DH.WHM12034	DH.WHM12044
for DU./Iw.	2,000	165 - 169	450	100	Ø 270 x 200	Ø 13 x 660	DH.WHM12035	DH.WHM12045
for Ki./Py.	2,000	161 - 164	450	100	Ø 270 x 200	Ø 13 x 660	DH.WHM120351	DH.WHM120451
for DU./Ki.	3,000	184 - 187	550	105	Ø 270 x 200	Ø 13 x 660	DH.WHM12036	DH.WHM12046
common-use	5,000	221 - 224	800	131	Ø 325 x 226	Ø 13 x 800	DH.WHM12037	DH.WHM12047
for DU./Ki.	6,000	234 - 237	800	131	Ø 325 x 226	Ø 13 x 800	DH.WHM12038	DH.WHM12048

Remarks: DU. = Duran®, Ki. = Kimax, Iw. = Iwaki, Py. = Pyrex

Accessories: Magnetic stirrer bars can be found on page 28

Heating mantle | round flasks

for spherical flasks, external controller available, up to 450°C

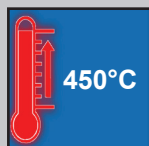

WHM for round flasks, 450°C for use with external controller

Ideal for:

- spherical flasks 50 - 6,000 ml
- use with magnetic stirrer

Features:

- full choice of vessel, capacity, housing and control are offered
- highly processed aluminium case offers robust standing, easy handling
- nickel chrome heating element
- coil type: acid-resistant, long life time
- K-type thermo sensor is basically embedded
- CE certified and unique serial number for tracing

Controller:

- optional remote thermo controllers are available (analog: WHM-C10A, digital: WHM-C10D)



1.000 ml round flask heating mantle



WHM-C10D
digital controller



WHM-C10A
analog controller

Application (flask brand)	Flask capacity (ml)	Flask Ø (mm)	Watts (W)	Inside depth (mm)	Mantle outside Ø x H mm	Support rod Ø x H mm	Order number	
							with 230V	with 120V
common-use	50	49 - 52	80	48	Ø 145 x 75	Ø 13 x 440	DH.WHM12050	DH.WHM12060
common-use	100	63 - 66	80	50	Ø 145 x 75	Ø 13 x 440	DH.WHM12051	DH.WHM12061
common-use	250	83 - 86	140	50	Ø 145 x 75	Ø 13 x 440	DH.WHM12052	DH.WHM12062
common-use	500	102 - 105	240	85	Ø 190 x 110	Ø 13 x 440	DH.WHM12053	DH.WHM12063
common-use	1,000	130 - 133	350	85	Ø 190 x 110	Ø 13 x 440	DH.WHM12054	DH.WHM12064
for DU./Iw.	2,000	165 - 169	450	110	Ø 270 x 135	Ø 13 x 660	DH.WHM12055	DH.WHM12065
for Ki./Py.	2,000	161 - 164	450	110	Ø 270 x 135	Ø 13 x 660	DH.WHM120551	DH.WHM120651
for DU./Ki.	3,000	184 - 187	550	110	Ø 270 x 135	Ø 13 x 660	DH.WHM12056	DH.WHM12066
common-use	5,000	221 - 224	800	140	Ø 325 x 165	Ø 13 x 800	DH.WHM12057	DH.WHM12067
for DU./Ki.	6,000	234 - 237	800	140	Ø 325 x 165	Ø 13 x 800	DH.WHM12058	DH.WHM12068

Remarks: DU. = Duran®, Ki. = Kimax, Iw. = Iwaki, Py. = Pyrex

Accessories: Remote controller and temperature probes on page 46

Heating mantle | round flasks

for spherical flasks, external controller available, up to 650°C

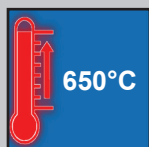

1.000 ml round flask heating mantle

WHM for round flasks, 650°C

for use with external controller
high maximal temperature

Ideal for:

- spherical flasks 100 - 10,000 ml
- use with magnetic stirrer

Features:

- full choice of vessel, capacity, housing and control are offered
- highly processed aluminium case offers robust standing, easy handling
- nickel chrome heating element
- coil type: acid-resistant, long life time
- K-type thermo sensor is basically embedded
- CE certified and unique serial number for tracing

Controller:

- optional remote thermo controllers are available (analog: WHM-C10A, digital: WHM-C10D)



WHM-C10D
digital controller



WHM-C10A
analog controller

Application (flask brand)	Flask capacity (ml)	Flask Ø (mm)	Watts (W)	Inside depth (mm)	Mantle outside Ø x H mm	Support rod Ø x H mm	Order number	
							with 230V	with 120V
common-use	100	63 - 66	120	50	Ø 145 x 75	Ø 13 x 440	DH.WHM12091	DH.WHM12101
common-use	250	86 - 86	200	50	Ø 145 x 75	Ø 13 x 440	DH.WHM12092	DH.WHM12102
common-use	500	102 - 105	350	60	Ø 190 x 85	Ø 13 x 440	DH.WHM12093	DH.WHM12103
common-use	1,000	130 - 133	450	85	Ø 190 x 110	Ø 13 x 440	DH.WHM12094	DH.WHM12104
for DU./lw.	2,000	165 - 169	600	110	Ø 270 x 135	Ø 13 x 660	DH.WHM12095	DH.WHM12105
for Ki./Py.	2,000	161 - 164	600	110	Ø 270 x 135	Ø 13 x 660	DH.WHM120951	DH.WHM121051
for DU./Ki.	3,000	184 - 187	700	110	Ø 270 x 135	Ø 13 x 660	DH.WHM12096	DH.WHM12106
common-use	5,000	221 - 224	1200	140	Ø 325 x 165	Ø 13 x 800	DH.WHM12097	DH.WHM12107
for DU./Ki.	6,000	234 - 237	1200	140	Ø 325 x 165	Ø 13 x 800	DH.WHM12098	DH.WHM12108
for DU.	10,000*	278 - 282	1800*	160	Ø 390 x 240	Ø 13 x 800	DH.WHM12099	DH.WHM12109*

* DH.WHM12109 is offered with 1 Phase 120V power cable
♦ 10,000 ml mantle steel case - magnetic stirring is not available

Remarks: DU. = Duran®, Ki. = Kimax, lw. = lwaki, Py. = Pyrex

Accessories: Remote controller and temperature probes on page 46

Heating mantle | round flasks

for big spherical flasks up to 20 L, external controller available, up to 450°C

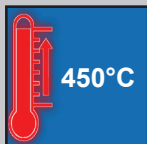

WHM for big round flasks, 450°C for use with external controller for 10 & 20 l flasks

Ideal for:

- big spherical flasks

Features:

- steel case, magnetic stirring is not available
- full choice of vessel, capacity, housing and control are offered
- nickel chrome heating element
- coil type: acid-resistant, long life time
- K-type thermo sensor is basically embedded
- CE certified and unique serial number for tracing

Controller:

- optional remote thermo controllers are available (analog: WHM-C10A, digital: WHM- C10D)

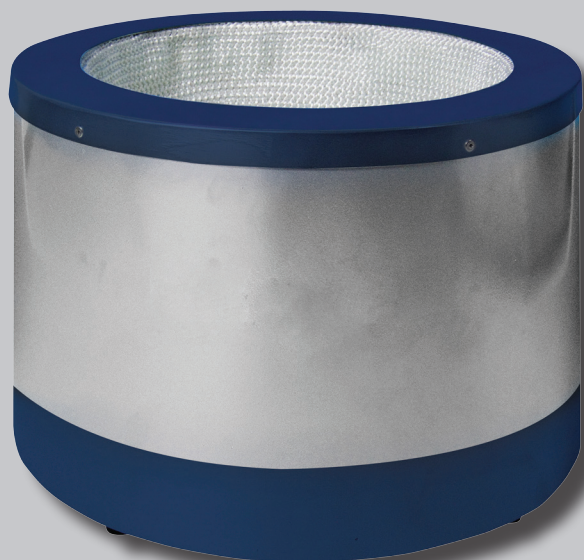

10l round flask heating mantle



WHM-C10D
digital controller



WHM-C10A
analog controller

Application (flask brand)	Flask capacity (l)	Flask Ø (mm)	Watts (W)	Inside depth (mm)	Mantle outside Ø x H mm	Support rod Ø x H mm	Order number	
							with 230V	with 120V
for DU.	10	278 - 282	1400	160	Ø 390 x 240	Ø 13 x 800	DH.WHM12073	DH.WHM12083
for DU.	20	344 - 348	2000	200	Ø 470 x 260	Ø 13 x 800	DH.WHM12074	DH.WHM12084*

* DH.WHM12084 is offered with 1 Phase 120V power cable

Remarks: DU. = Duran®, Ki. = Kimax, Iw. = Iwaki, Py. = Pyrex

Accessories: Remote controller and temperature probes on page 46

Heating mantle | reaction vessels

for reaction vessels, integrated magnetic stirrer and controller, 100°C - 450°C

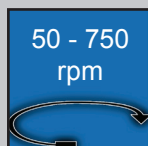
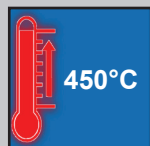

WHM for reaction vessels 100°C - 450°C

with built-in magnetic stirrer
integrated controller



1,000 ml reaction vessel heating mantle

Ideal for:

- reaction vessels 500 - 7,000 ml

Features:

- nickel chrome heating element
- coil type: acid-resistant, long life time
- K-type thermo sensor is basically embedded, which enables precise control of the temperature of liquid sample in the vessel when used together with remote digital controller
- full choice of vessel, capacity, housing and control are offered
- CE certified and unique serial number for tracing

Controller:

- built-in *stirring and temperature controller*



2x stirrer bars included

Vessel capacity (ml)	Vessel Ø (cm)	Watts (W)	Inside depth (mm)	Mantle outside Ø x H mm	Support rod Ø x H mm	Order number
						with 230V
500	Ø 11 x 10	240	72	Ø 190 x 165	Ø 13 x 660	DH.WHM722100
1,000	Ø 11 x 15	350	107	Ø 270 x 200	Ø 13 x 660	DH.WHM722101
2,000	Ø 13 x 19	450	142	Ø 270 x 235	Ø 13 x 660	DH.WHM722102
3,000	Ø 13 x 28	550	177	Ø 325 x 270	Ø 13 x 800	DH.WHM722103
5,000	Ø 16 x 29	800	177	Ø 325 x 270	Ø 13 x 800	DH.WHM722104
6,000	Ø 21.5 x 24	800	177	Ø 325 x 270	Ø 13 x 800	DH.WHM722105
7,000	Ø 21.5 x 25	850	177	Ø 325 x 270	Ø 13 x 800	DH.WHM722106

Accessories: Magnetic stirrer bars can be found on page 28

Heating mantle | reaction vessels

for reaction vessels, external controller available, 100°C - 450°C

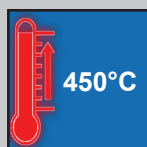

WHM for reaction vessels 100°C - 450°C

Ideal for:

- reaction vessels 500 ml - 10 l

Features:

- nickel chrome heating element
- coil type: acid-resistant, long life time
- K-type thermo sensor is basically embedded, which enables precise control of the temperature of liquid sample in the vessel when used together with remote digital controller
- cylindrical-type
- highly processed aluminium case offers robust standing, easy handling and usability on the magnetic stirrer
- full choice of vessel, capacity, housing and control are offered
- CE certified and unique serial number for tracing

Controller:

- optional remote thermo controller is available (analog: WHM-C10A, digital: WHM-C10D)



10,000 ml reaction vessel heating mantle



WHM-C10D digital controller



WHM-C10A analog controller

with aluminium case, 0,5 - 10l, can be used with magnetic stirrers

Flasks capacity (ml)	Flask Ø (cm)	Watts (W)	Inside depth (mm)	Mantle outside Ø x H mm	Support rod Ø x H mm	Order number
						with 230V
500	Ø 11 x 10	240	80	Ø 190 x 110	Ø 13 x 660	DH.WHM12211
1,000	Ø 11 x 15	350	115	Ø 190 x 135	Ø 13 x 660	DH.WHM12212
2,000	Ø 13 x 19	450	140	Ø 190 x 160	Ø 13 x 660	DH.WHM12213
3,000	Ø 13 x 28	550	210	Ø 270 x 235	Ø 13 x 800	DH.WHM12214
5,000	Ø 16 x 29	800	210	Ø 270 x 235	Ø 13 x 800	DH.WHM12215
6,000	Ø 21.5 x 24	800	210	Ø 325 x 226	Ø 13 x 800	DH.WHM12216
7,000	Ø 21.5 x 25	850	210	Ø 325 x 226	Ø 13 x 800	DH.WHM122161
10,000	Ø 21.5 x 33	1400	245	Ø 325 x 270	Ø 13 x 800	DH.WHM12217
10,000	Ø 24 x 31	1400	245	Ø 325 x 270	Ø 13 x 800	DH.WHM122171

with steel case, 20 l, no use with magnetic stirrers

Flasks capacity (l)	Flask Ø (cm)	Watts (kW)	Inside depth (mm)	Mantle outside Ø x H mm	Support rod Ø x H mm	Order number
						with 230V
20	Ø 27 x 45	2	360	Ø 390 x 410	Ø 13 x 800	DH.WHM12218
20	Ø 29 x 42	2	360	Ø 390 x 410	Ø 13 x 800	DH.WHM122181

Accessories: Remote controller and temperature probes on page 46

Heating mantle | reaction vessels

for reaction vessels with bottom outlet, external controller available, 100°C - 450°C

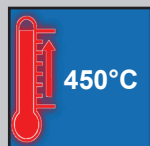

WHM for reaction vessels 100°C - 450°C

Ideal for:

- reaction vessels 500 ml - 20 l with bottom outlet

Features:

- nickel chrome heating element
- coil type: acid-resistant, long life time
- K-type thermo sensor is basically embedded, which enables precise control of the temperature of liquid sample in the vessel when used together with remote digital controller
- cylindrical-type with bottom outlet
- full choice of vessel, capacity, housing and control are offered
- CE certified and unique serial number for tracing

Controller:

- optional remote thermo controller is available (analog: WHM-C10A, digital: WHM-C10D)

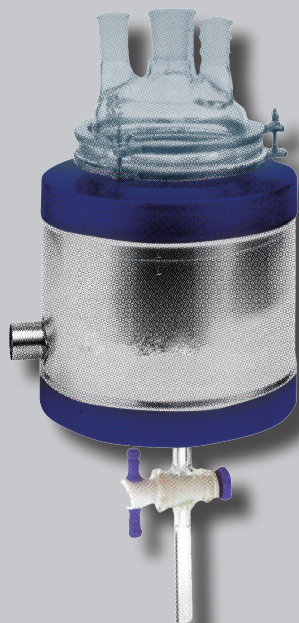

2.000 ml reaction vessel heating mantle with bottom outlet



WHM-C10D digital controller



WHM-C10A analog controller

with aluminium case, 0,5 - 10l

Flasks capacity (ml)	Flask Ø (cm)	Watts (W)	Inside depth (mm)	Mantle outside Ø x H mm	Bottom outlet (hole) l+w (mm)	Support rod Ø x H mm	Order number
							with 230V
500	Ø 11 x 10	240	80	Ø 190 x 110	72 x 40	Ø 13 x 660	DH.WHM12231
1,000	Ø 11 x 15	350	115	Ø 190 x 135	72 x 40	Ø 13 x 660	DH.WHM12232
2,000	Ø 13 x 19	450	145	Ø 200 x 170	72 x 40	Ø 13 x 800	DH.WHM12233
3,000	Ø 13 x 28	550	195	Ø 200 x 220	72 x 40	Ø 13 x 800	DH.WHM12234
5,000	Ø 16 x 29	800	210	Ø 270 x 235	120 x 70	Ø 13 x 800	DH.WHM12235
6,000	Ø 21.5 x 24	800	195	Ø 325 x 220	120 x 70	Ø 13 x 800	DH.WHM12236
7,000	Ø 21.5 x 25	850	210	Ø 325 x 226	120 x 70	Ø 13 x 800	DH.WHM122361
10,000	Ø 21.5 x 33	1400	250	Ø 325 x 270	120 x 70	Ø 13 x 800	DH.WHM12237
10,000	Ø 24 x 31	1400	250	Ø 325 x 270	120 x 70	Ø 13 x 800	DH.WHM122371

with steel case, 20 l / 50 l / 100 l, no use with magnetic stirrers

Flasks capacity (l)	Flask Ø (cm)	Watts (kW)	Inside depth (mm)	Mantle outside Ø x H mm	Bottom outlet (hole) l+w (mm)	Support rod Ø x H mm	Order number
							with 230V
20	Ø 27 x 45	2	360	Ø 390 x 410	120 x 70	Ø 13 x 800	DH.WHM12238
20	Ø 29 x 42	2	360	Ø 390 x 410	120 x 70	Ø 13 x 800	DH.WHM122381

Please note: contact our sales team if you're interested in buying matching glass reaction vessels!

Mail: info@witeg.de

Phone: +49 (0)9342 / 9301-0

Fax: +49 (0)9342 / 9301-77

Accessories: Remote controller and temperature probes on page 46

Heating mantle | multi-place

multi-places (3 or 6), individual controller for each place, 100°C - 450°C

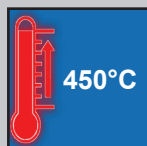

WHM multi-place, 100°C - 450°C

Ideal for:

- repetitive extraction (Kjeldahl, Soxhlet and other extraction procedures), laboratory reflux and distillation applications
- Duran®, Kimax, Pyrex and Iwaki-brand round flask

Features:

- nickel chrome heating element
- coil type: acid-resistant, long life time
- highly processed aluminium case offers robust standing
- easy handling
- lower profile for space-saving convenience
- three support rods and two hooks included
- CE certified and unique serial number for tracing

Controller:

- built-in analog controller



6-places heating mantle
with three rods and two hooks (included)



3-places heating mantle

6-places heating mantle

Flask capacity (ml)	Flask		Watts (W)	Inside depth (mm)	Dimensions W x D x H (mm)	Order number	
	max. Ø (cm)	Bottom				with 230V	with 120V
250/300	83 - 86	flat	840	50	800 x 240 x 110	DH.WHM12291	DH.WHM12292
250/300	83 - 86	round	840	50	800 x 240 x 110	DH.WHM12293	DH.WHM12294
500	102 - 105	round	1440	65	950 x 270 x 130	DH.WHM12295	DH.WHM12296

3-places heating mantle

Flask capacity (ml)	Flask		Watts (W)	Inside depth (mm)	Dimensions W x D x H (mm)	Order number	
	max. Ø (cm)	Bottom				with 230V	with 120V
500	102 x 105	round	720	65	550 x 270 x 130	DH.WHM12391	DH.WHM12392
1,000	130 x 131	round	1050	75	690 x 340 x 170	DH.WHM12393	DH.WHM12394

Please note: No clamps, bossheads or extraction apparatus included!

Accessories: Suitable extraction apparatus can be found on page 233

Suitable clamps and bossheads can be found on page 215. Recommended: bosshead 7 400 502 and clamp 7 400 720.

Heating mantle

Accessories: Remote controller and temperature probes



WHM-C10A analog controller

Ideal for:

- all-purpose heating instruments

Features:

- small footprint, compact analog temperature controller
- precise manual control of heating mantles, tapes, cords and others resistive loads up to 1.2 kW
- safe and durable design
- solid state, proportional voltage power control (5~100% or rated voltage)
- CE certified and unique serial number for tracing

Model	WHM-C10A	
	120V	230V
Dimension	160 x 128 x 145 mm, 1 kg	
Packing size	190 x 160 x 130 mm, 2 kg	
Power supply	1 Phase AC 120V, 60 Hz	1 Phase AC 230V, 50/60Hz
Order number	DH.WHM23500	DH.WHM13500



WHM-C10D digital controller

Ideal for:

- all-purpose heating instruments

Features:

- user's self-compensation function to offset between actual and displayed temperature ($\pm 50.0^{\circ}\text{C}$)
- digital feedback control by high-performance microprocessor
- small footprint and user-friendly design
- storage function, alarm, timer and locking mode
- heating instruments can be controlled up to 2kW
- accurate temperature control of the liquid in the vessel using optional direct K-type sensor
- backlight LCD display
- CE certified and unique serial number for tracing

Model	WHM-C10D	
	120V	230V
Temperature range & accuracy	ambient to $+5 - 700^{\circ}\text{C}$ $\pm 1^{\circ}\text{C}$ at set temperature	
Temperature resolution	1°C - display, 1°C - control	
Timer & alarm	99hr 59 min (continuous run), errorstatus & timer end	
Control capacity	up to 2 kW	up to 1.5 kW
Dimension	206 x 207 x 99 mm, 2.8 kg	
Packing size	280 x 250 x 110 mm, 4 kg	
Power supply	1 Phase AC 120V, 60 Hz	1 Phase AC 230V, 50/60 Hz
Order number	DH.WHM22500	DH.WHM12500

Temperature probes for heating mantle controller WHM-C10D

	Measurements	Article	Order number
Standard	$\text{Ø}4,8 \times \text{L}250 \text{ mm}$	SS300	DH.WHP503040
Standard	$\text{Ø}4,8 \times \text{L}380 \text{ mm}$	SS400	DH.WHP503050
PTFE-coated	$\text{Ø}4,8 \times \text{L}250 \text{ mm}$	SS310	DH.WHP503041
PTFE-coated	$\text{Ø}4,8 \times \text{L}380 \text{ mm}$	SS410	DH.WHP503051

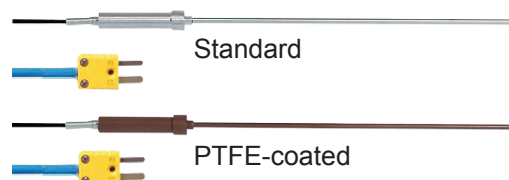

Please note: the digital controller WHM-C10D only works in combination with one of the offered temperature probes! Without temperature probe the device can't be used. Please choose from the probes on the right side.

Heating tape

two sizes with different lengths available, up to 250°C



WHM heating tapes, up to 250°C

13 mm width x length (m)	Watts & Volt	Order number
13 mm x 0.6 m	200 W, 230V	DH.WHM12311
13 mm x 1.0 m	200 W, 230V	DH.WHM12312
13 mm x 1.5 m	250 W, 230V	DH.WHM12313
13 mm x 2.0 m	300 W, 230V	DH.WHM12314
13 mm x 2.5 m	350 W, 230V	DH.WHM12315
13 mm x 3.0 m	400 W, 230V	DH.WHM12316

25 mm width x length (m)	Watts & Volt	Order number
25 mm x 0.6 m	200 W, 230V	DH.WHM12321
25 mm x 1.0 m	200 W, 230V	DH.WHM12322
25 mm x 1.5 m	250 W, 230V	DH.WHM12323
25 mm x 2.0 m	300 W, 230V	DH.WHM12324
25 mm x 2.5 m	350 W, 230V	DH.WHM12325
25 mm x 3.0 m	400 W, 230V	DH.WHM12326
25 mm x 4.0 m	550 W, 230V	DH.WHM12327
25 mm x 6.0 m	700 W, 230V	DH.WHM12328

All heating tapes can be controlled by WHM-C10A or WHM-C10D controller.

Bath | water bath

digital, 6 / 11 / 22 l, up to 100°C ±0.1°C, flat lid included

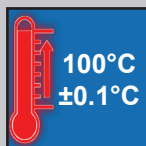

IQ | OQ
available
page 12 for details

WB 100°C, digital

Ideal for:

- water bath for general purpose

Features:

- user's self-compensation function to control difference between real temperature and indicated temperature (±10.0°C)
- stainless steel bath & lid for superior durability & high thermal efficiency / consistency, dome lid optional
- digital timer function (99hr 59min): delay time and operation time can be controlled
- storage function for the set values of temperature and timer
- backlight LCD display
- CE-certified and unique serial number for tracing

Safety mechanism:

- locking mode
- over-temperature and over-current protection
- sensor error protection

Controller:

- digital fuzzy controller with **Jog-Shuttle-switch** (turn + push)



WB-11 with flat lid (included)

Model	WB-6	WB-11	WB-22
Capacity	6 l	11 l	22 l
Temperature range & accuracy	room temperature +5°C - 100°C, ±0.1°C		
Temperature resolution	0.1°C-display, 0.1°C-control		
Temperature uniformity & probe	±1.0°C, PT100		
Heating power	800 W	1 kW	2 kW
Timer & alarm	99hr 59 min (delay & continuous run), error status & timer end		
Drain valve	-		mounted (Ø9.5 - 11 mm)
Effective space	300 x 155 x 110 mm	302 x 240 x 110 mm	500 x 295 x 110 mm
Internal dimensions (W x D x H)	300 x 155 x 150 mm	302 x 240 x 150 mm	500 x 295 x 150 mm
External dimensions (W x D x H)	325 x 180 x 260 mm	325 x 265 x 260 mm	535 x 330 x 260 mm
Packing size & gross weight	350 x 210 x 310 mm, 8 kg	350 x 300 x 310 mm, 10 kg	570 x 360 x 310 mm, 14 kg
Power supply	1 Phase AC 120V, 60 Hz or AC 230V, 50/60 Hz		
Order number 230V	DH.WB000106	DH.WB000111	DH.WB000122
Order number 120V	DH.WB000206	DH.WB000211	DH.WB000222

Accessories:



Lid with concentric ring, stainless steel

Measurements	Article	Order number
for WB-6, 2 rings, 330x182xh20 mm	BFC106	DH.WB030106
for WB-11, 2 rings, 329x269xh20 mm	BFC111	DH.WB030111
for WB-22, 6 rings, 539x334xh20 mm	BFC122	DH.WB030122



Dome lid for water bath WB, stainless steel

Measurements	Article	Order number
for WB-6, 324x176xh100 mm	BD206	DH.WB010206
for WB-11, 324x263xh100 mm	BD211	DH.WB010211
for WB-22, 533x328xh100 mm	BD222	DH.WB010222



Tube rack, stainless steel

Measurements	Article	Order number
for WB-6, 36x Ø17 mm, 220x125xh79 mm	BTH106	DH.WB020106
for WB-6, 15x Ø32 mm, 220x125xh79 mm	BTH206	DH.WB020206
for WB-11, 63x Ø17 mm, 220x205xh79 mm	BTH111	DH.WB020111
for WB-11, 25x Ø32 mm, 220x205xh79 mm	BTH211	DH.WB020211

for WB-22 please choose between 4x BTH106/206 or 2x BTH111/211

Bath | oil bath

oil bath, digital, 6 / 11 / 22 l, up to 250°C ±1.5°C, flat lid included

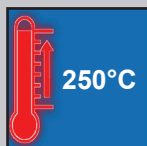

WHB-11

Flat lid (included)

WHB oil bath, 250°C, digital

Ideal for:

- oil bath for general purpose with high temperature

Features:

- user's self-compensation function to control difference between real temperature and indicated temperature
- stainless steel bath & lid for superior durability & high thermal efficiency / consistency
- digital timer function (99hr 59min): delay time and operation time can be controlled
- storage function for the set values of temperature and timer
- backlight LCD display
- CE-certified and unique serial number for tracing

Safety mechanism:

- locking mode
- over-temperature and over-current protection
- sensor error protection

Controller:

- digital fuzzy controller with **Jog-Shuttle-switch** (turn + push)

Model	WHB-6	WHB-11	WHB-22
Capacity	6 l	11 l	22 l
Temperature range & accuracy	room temperature +5°C - 250°C, ±1.5°C		
Temperature resolution	0.1°C-display, 0.1°C-control		
Temperature uniformity & probe	±3.0°C, PT100		
Heating power	1.5 kW	2 kW	2.5 kW
Timer & alarm	99hr 59 min (delay & continuous run), error status & timer end		
Drain valve	mounted		
Effective space	270 x 170 x 110 mm	300 x 250 x 110 mm	400 x 300 x 140 mm
Internal dimensions (W x D x H)	270 x 180 x 150 mm	300 x 250 x 150 mm	400 x 300 x 180 mm
External dimensions (W x D x H)	425 x 305 x 340 mm	425 x 375 x 340 mm	525 x 425 x 370 mm
Packing size & gross weight	470 x 400 x 500 mm, 23 kg	600 x 490 x 500 mm, 25 kg	600 x 490 x 500 mm, 39 kg
Power supply	1 Phase AC 120V, 60 Hz or AC 230V, 50/60 Hz		
Order number 230V	DH.WHB00106	DH.WHB00111	DH.WHB00122
Order number 120V	DH.WHB00206	DH.WHB00211	DH.WHB00222

Bath | water bath

extraction water bath, 4 / 6 / 8 places, up to 100°C ±0.2°C, holding frame and covers included

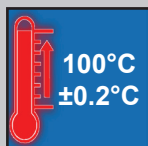

100°C
±0.2°C

WEB-6 with holding frame (included) and concentric ring covers (included)



WEB-4 with concentric ring covers (included)

WEB 100°C, 4/6/8 places, digital

Ideal for:

- gentle extraction, soxhlet extraction and determination of COD

Features:

- available with 4,6 or 8 extraction places
- user's self-compensation function to control difference between real temperature and indicated temperature (±10.0°C)
- concentric ring cover set Ø 110 mm and stainless steel holding frame included, drain valve mounted
- stainless steel interior and powder-coated steel body
- storage function for the set values of temperature and timer
- backlight LCD display
- CE certified and unique serial number for tracing

Safety mechanism:

- overheat and over-current protection
- sensor error detection
- locking mode
- low water level warning and automatic stop function

Controller:

- digital fuzzy controller with **Jog-Shuttle-switch** (turn + push)

Model	WEB-4	WEB-6	WEB-8
Temperature range & accuracy	room temperature +5°C - 100°C, ±0.2°C		
Temperature uniformity & sensor	±1.0°C, PT100		
No. of extraction holes	4 places	6 places	8 places
Heating power	1.4 kW	1.8 kW	2 x 1.4 kW
Timer & alarm	99hr 59 min (delay & continuous run), error status & timer end		
Internal dimensions (W x D x H)	610 x 160 x 160 mm	910 x 140 x 160 mm	610 x 290 x 160 mm
External dimensions (W x D x H)	720 x 245 x 275 mm	975 x 245 x 275 mm	720 x 375 x 275 mm
Packing size & gross weight	710 x 310 x 300 mm, 18 kg	1,030 x 320 x 370 mm, 25 kg	880 x 420 x 300 mm, 34 kg
Power supply	1 Phase AC 120V, 60 Hz or AC 230V, 50/60 Hz		
Order number 230V	DH.WEB01004	DH.WEB01006	DH.WEB01008
Order number 120V	DH.WEB02004	DH.WEB02006	DH.WEB02008

Scope of supply:

- WEB water bath
- holding frame
- concentric ring covers

Accessories:



Holding frame set, stainless steel

Measurements	Article	Order number
for WEB-4, 2x800mm pole, 2x700mm pole	EBF100	DH.WEB21004
for WEB-6, 2x800mm pole, 2x1.020mm pole	EBF200	DH.WEB21006
for WEB-8, 4x800mm pole, 4x740mm pole	EBF300	DH.WEB21008



Lid with concentric ring, stainless steel

	Article	Order number
for all WEB models	EBC100	DH.WEB11000

Bath | viscosity bath

viscosity water bath with window, 100°C ±0.1°C, lid with 5 holes included

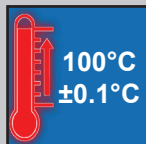

IQ | OQ
available
page 12 for details



WVB-30 with lid (included)
and viscometer holder WV B02010 (optional)



WVB viscosity bath, 100°C

Ideal for:

- precise measurement with capillary viscometers

Features:

- powerful circulation pump ensures highest temperature uniformity
- stainless steel interior and lid with 5 holes for viscometer holder, powder-coated steel body, vacuum sealed and tempered safety glasses window
- storage function for the set values of temperature and timer
- digital timer function (99hr 59min): delay time and operation time can be controlled
- user's self-compensation function to control difference between real temperature and indicated temperature (±10.0°C)
- drain valve mounted
- backlight LCD display
- CE certified and unique serial number for tracing

Safety mechanism:

- overheat and over-current protection
- sensor error detection
- locking mode

Controller:

- digital fuzzy controller with **Jog-Shuttle-switch** (turn + push)

Model	WVB-30
Temperature range & accuracy	room temperature +5°C - +100°C, ±0.1°C
Temperature resolution	0.1°C-display, 0.1°C-control
Temperature uniformity & probe	±0.2°C, PT100
Heating Power	2 kW
Pump	magnetic drive, max. flow rate 30 l/min
Timer & alarm	99hr 59 min (delay & continuous run), error status & timer end
Viewing window size	230 x 180 mm
Effective space	330 x 300 x 260 mm
Internal dimensions (W x D x H, mm)	350 x 300 x 300 mm
External dimensions (W x D x H, mm)	585 x 375 x 420 mm
Packing size & gross weight	640 x 450 x 500 mm, 24 kg
Power supply	1 Phase AC 120V, 60 Hz or AC 230V, 50/60 Hz
Order number 230V	DH.WVB01030
Order number 120V	DH.WVB02030

Accessories:



Spare flat lid, stainless steel

Measurements	Article	Order number
for WV B, 5 holes Ø50mm, suitable for viscometer holder WV B02010/11/12	VBF030	DH.WVB11030

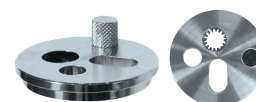

Viscometer holder

For...	Article	Order number
for Ubbelohde, Ostwald, etc.	WVB02010	DH.WVB02010
for Cannon-Fenske Routine / Reverse Flow	WVB02011	DH.WVB02011
for thread-type Ubbelohde	WVB02012	DH.WVB02012

Bath | circulation water bath

circulation water bath, 6 / 11 / 22l, up to 100°C ±0.1°C, 5 l/min, flat lid included

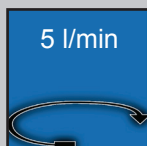
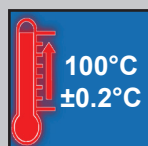

IQ | OQ
available
page 12 for details



WCB-22 with flat lid (included)



Stainless steel flat lid (included)

WCB 100°C, 5 l/min, 6/11/22 l

Ideal for:

- biotechnology, clinical, environmental, medical, petroleum & food industry, pharmaceutical and industrial applications
- connection with evaporators and viscometers is applicable

Features:

- user's self-compensation function to control difference between real temperature and indicated temperature (±10.0°C)
- stainless steel bath & lid for superior durability & high thermal efficiency / consistency
- storage function for the set values of temperature and timer
- powerful circulation pump assures temperature uniformity: internal and external circulation
- storage function for the set values of temperature and timer
- backlight LCD display
- CE certified and unique serial number for tracing

Safety mechanism:

- locking mode
- over-temperature and over-current protection
- sensor error detection
- low water level warning and automatic stop function

Controller:

- digital fuzzy controller with **Jog-Shuttle-switch** (turn + push)

Model	WCB-6	WCB-11	WCB-22
Capacity	6 l	11 l	22 l
Temperature range & accuracy	room temperature +5°C - 100°C, ±0.1°C		
Temperature resolution, uniformity & probe	0.1°C-display, 0.1°C-control, ±0.2°C, PT100		
Heating power	800 W	1 kW	2 kW
Pump	max. flow rate 5 l/min (internal/external)		
Circulation nozzle	inner Ø 7 x outer Ø 11 mm (inner Ø 9/outer Ø 12 mm silicon tube connection for inner circulation)		
Timer & alarm	99hr 59 min (delay & continuous run), error status & timer end		
Drain valve	-		mounted (Ø9.5 - 11 mm)
Effective space	120 x 155 x 150 mm	170 x 240 x 150 mm	372 x 295 x 150 mm
Internal dimensions (W x D x H)	300 x 155 x 150 mm	302 x 240 x 150 mm	500 x 295 x 150 mm
External dimensions (W x D x H)	330 x 185 x 385 mm	335 x 275 x 385 mm	540 x 335 x 410 mm
Packing size & gross weight	350 x 210 x 340 mm, 11 kg	360 x 300 x 420 mm, 13 kg	580 x 380 x 470 mm, 18 kg
Power supply	1 Phase AC 120V, 60 Hz or AC 230V, 50/60 Hz		
Order number 230V	DH.WCB00106	DH.WCB00111	DH.WCB00122
Order number 120V	DH.WCB00206	DH.WCB00211	DH.WCB00222

Bath | circulation water bath

circulation water bath, 6 / 11 / 22 / 30 l, up to 250°C ±0.1°C, 16 l/min, flat lid included

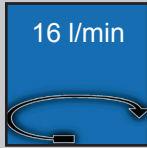
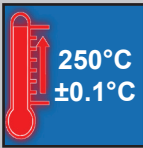

WCH 250°C, 16 l/min, 6/12/22/30 l

Ideal for:

- applications at high temperature
- biotechnology, clinical, environmental, medical, petroleum & food industry, pharmaceutical and industrial applications
- connection with evaporators and viscometers is applicable

Features:

- corrosion resistant stainless steel bath with 1.2 mm thickness
- ceramic fiber insulator of 50 mm thickness and powder-coated steel body
- user's self-compensation function to control difference between real temperature and indicated temperature (±10.0°C)
- digital timer function (99hr 59min): delay time and operation time can be controlled
- drain valve mounted and stainless steel flat lid included
- storage function for the set values of temperature and timer
- backlight LCD display
- CE certified and unique serial number for tracing

Safety mechanism:

- overheat and over-current protection
- sensor error detection
- locking mode

Controller:

- digital fuzzy controller with **Jog-Shuttle-switch** (turn + push)

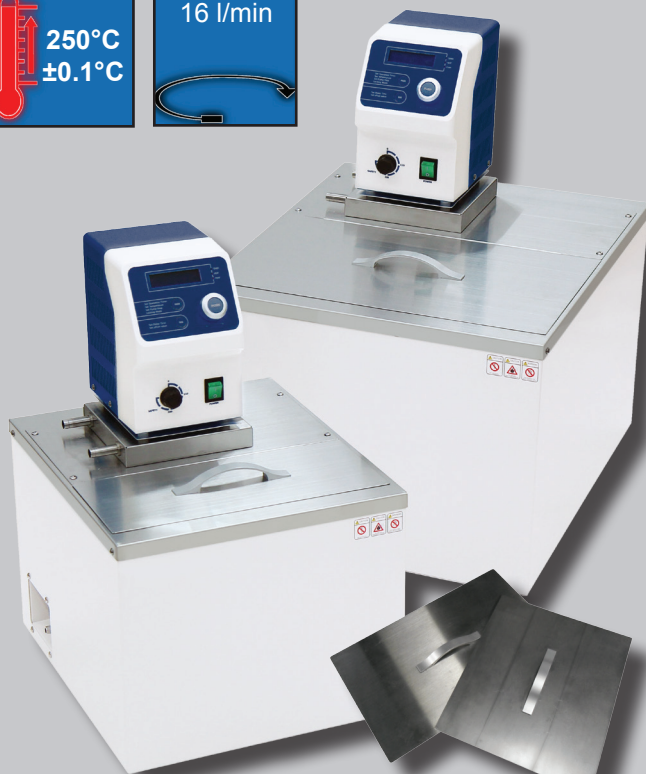

Stainless steel flat lid (included)

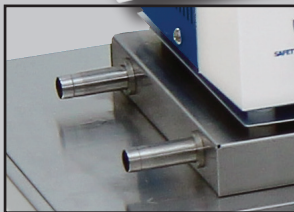

Connection for external circulation Ø12.5mm

Model	WCH-8	WCH-12	WCH-22	WCH-30
Capacity	8 l	12 l	22 l	30 l
Temperature range & accuracy	room temperature +5°C - 250°C, ±0.1°C			
Temperature resolution	0.1°C-display, 0.5°C-control			
Temperature uniformity & probe	±0.2°C, PT100			
Heating Power	1.0 kW	1.5 kW	2.2 kW	2.5 kW
External circulation nozzle	inner Ø10.5 mm, outer Ø12.5 mm			
Pump	max. flow rate: 16l/min, max. pressure: 5 psi, max. lift: 2.8m			
Timer & alarm	99hr 59 min (delay & continuous run), error status & timer end			
Effective space	180 x 130 x 155 mm	250 x 130 x 155 mm	340 x 250 x 155 mm	340 x 250 x 200 mm
Internal dimensions (W x D x H)	180 x 320 x 155 mm	250 x 320 x 155 mm	340 x 440 x 155 mm	340 x 440 x 200 mm
External dimensions (W x D x H)	303 x 443 x 569 mm	373 x 443 x 569 mm	463 x 563 x 569 mm	436 x 563 x 614 mm
Packing size & gross weight	470 x 400 x 500 mm, 19 kg	470 x 400 x 500 mm, 21 kg	600 x 490 x 500 mm, 23 kg	600 x 490 x 500 mm, 37 kg
Power supply	1 Phase AC 120V, 60 Hz or AC 230V, 50/60 Hz			
Order number 230V	DH.WCH00408	DH.WCH00412	DH.WCH00422	DH.WCH00430
Order number 120V	DH.WCH00508	DH.WCH00512	DH.WCH00522	DH.WCH00530

Bath | circulation water bath

Circulation immersion pump head, 11 / 22 l, up to 100°C ±0.1°C, 5 l/min,

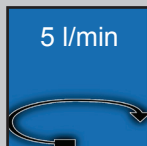
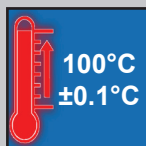

rear

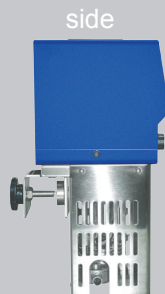

side



WCB-11H

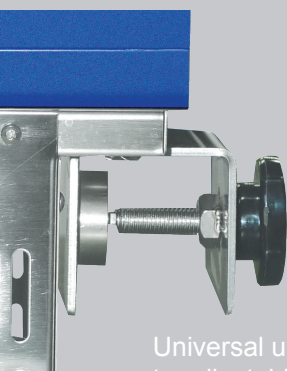

Universal use due to adjustable lug

WCB-H 100°C, 11/22 l, digital

Ideal for:

- multi-use digital precise immersion circulator head

Features:

- user's self-compensation function to control difference between real temperature and indicated temperature (±10.0°C)
- digital timer function (99hr 59min): delay time and operation time can be controlled
- powerful circulation pump assures temperature uniformity
- storage function for the set values of temperature and timer
- backlight LCD display
- CE certified and unique serial number for tracing

Safety mechanism:

- locking mode
- over-temperature and over-current protection
- sensor error detection
- low water level warning and automatic stop function

Controller:

- digital fuzzy controller with **Jog-Shuttle-switch** (turn + push)

Model	WCB-11H	WCB-22H
Capacity	11 l	22 l
Temperature range & sensor	room temperature +5°C - 100°C ±0.1°C; PT100	
Heating power	1 kW	2 kW
Pump	5 l/min	
Timer & alarm	99hr 59 min (delay & continuous run), error status & timer end	
External dimensions (W x D x H)	130 x 165 x 320 mm	
Packing size & gross weight	400 x 280 x 200 mm, 8 kg	400 x 280 x 200 mm, 10 kg
Power supply	1 Phase AC 120V, 60 Hz or AC 230V, 50/60 Hz	
Order number 230V	DH.WCB10011	DH.WCB10022
Order number 120V	DH.WCB20011	DH.WCB20022

Bath | shaking water bath

shaking water bath, 18 / 30 / 45 l, up to 100°C ±0.1°C, shaking stroke 20mm

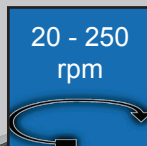
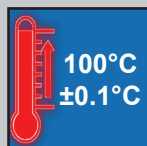

WSB-30 with universal spring rack (included)

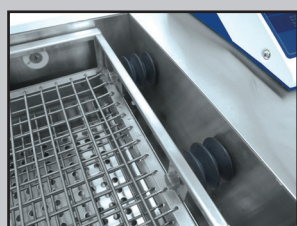

No water leak possible due to completely sealed bath.



WSB shaking water bath, 100°C

Ideal for:

- direct immersion of samples for shaking in the field of biotechnology and laboratories, hybridization applications, cell cultures, cell aeration, increasing solubility rates, molecular biology assays and bacterial cultures

Features:

- stainless steel interior and bath, powder-coated steel body, double painted & baked body, 20 mm polyurethane-insulation
- high-performance shaking engine ensures best smoothly shaking motion, minimum noise and vibration
- universal stainless steel spring rack included: for various kind of flasks and tubes (up to 2l), easy to disassemble
- user's self-compensation function to control difference between real temperature and indicated temperature (±10.0°C)
- drain valve mounted
- backlight LCD display
- CE certified and unique serial number for tracing

Safety mechanism:

- overheat and over-current protection
- sensor error detection

Controller:

- **Jog-Dial** controller (turn + push)
- digital feedback controller for precise speed control
- digital fuzzy controller for precise temperature control

Model	WSB-18	WSB-30	WSB-45
Capacity	18 l	30 l	45 l
Temperature range & accuracy	room temperature +5°C - +100°C, ±0.1°C		
Temperature resolution	0.1°C-display, 0.1°C-control		
Temperature uniformity & probe	±0.5°C at -20°C, PT100		
Heating Power	1.4 kW	1.8 kW	2.4 kW
Shaking speed & resolution	20 - 250 rpm, 1 rpm-display / 1 rpm-control		
Shaking stroke	20 mm (other strokes by request)		
Max. quantity of Erlenmeyer Flasks	6 x 250 ml, 4 x 500 ml, 1 x 1000 ml	10 x 250 ml, 8 x 500 ml, 3 x 1000 ml	18 x 250 ml, 15 x 500 ml, 8 x 1000 ml
Timer & alarm	99hr 59 min (temperature delay & continuous run), error status & timer end		
Internal dimensions (W x D x H, mm)	300 x 300 x 200 mm	500 x 300 x 200 mm	600 x 380 x 200 mm
External dimensions (W x D x H, mm)	563 x 353 x 340 mm	763 x 353 x 340 mm	863 x 433 x 340 mm
Packing size & gross weight	620 x 420 x 450 mm, 24 kg	820 x 420 x 450 mm, 26 kg	920 x 500 x 450 mm, 32 kg
Power supply	1 Phase AC 120V, 60 Hz or AC 230V, 50/60 Hz		
Order number 230V	DH.WSB03018	DH.WSB03030	DH.WSB03045
Order number 120V	DH.WSB03218	DH.WSB03230	DH.WSB03245

Accessories:



Dome lid for shaking water bath WSB

Measurements	Article	Order number
for WSB-18, 363x353xh69 mm, stainless steel	SBD018	DH.WSB02018
for WSB-30, 563x353xh69 mm, stainless steel	SBD030	DH.WSB02030
for WSB-45, 663x433xh69 mm, stainless steel	SBD045	DH.WSB02045

Incubator Oven

Controller SMART-Lab™ Jog-Dial

Anytime - Anywhere connected laboratory



SMART-Lab™ Controller



- full touch screen TFT LCD:
- WiRe™ app service, remote control system
- variable program settings
- self-diagnosis and interactive temperature graph
- automatic data recording and password protection
- data transfer to PC by USB memory
- digital calibration (offset function)
- min-/max-temperature memory & program function
- push-alarm service to smartphone or tablet PC

more information on 8 - 11

SMART-Lab devices

Incubator	Oven
SWIG 70°C, 32 / 50 / 105 / 155 l - page 59	SWON 230°C, 32/50/105/155 l - page 75
SWIF 70°C, 50/105/155 l - page 61	SWOF 250°C, 50/105/155 l - page 77
SWIR 0-60°C, refrigerated - page 63	SWOV 200°C, 18.6/30/70 l, 750mmHg - page 79
STH -20/-40°C, 98% rel. hum. - page 70	
STH-E -20°C, 95% rel. hum. - page 71	
SWGC Illumination, 95% rel. hum. - page 72	

Jog-Dial controller

- ergonomic design for easy and convenient usage
- 2-way Jog-Dial knob provides simple setting of required temperature and time
- high quality illuminated LCD
- „MAIN“ and „SUB“ button to access all menus



Incubator	Oven
WIG 70°C, 32 / 50 / 105 / 155 l on page 58	WON 230°C, 32/50/105/155 l on page 74
WIF 70°C, 50/105/155 l on page 60	WOF 250°C, 50/105/155 l on page 76
WIR 0-60°C, refrigerated on page 62	WOV 200°C, 18.6/30/70 l, 750mmHg on page 78

Incubator Oven

General information

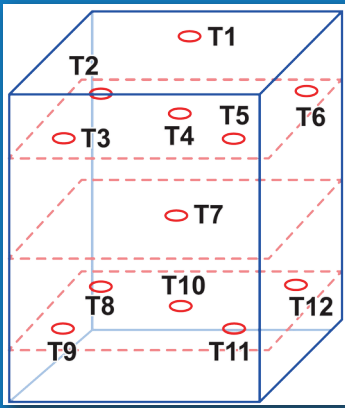

Temperature uniformity successfully tested by ASTM standards

All incubators and ovens are thoroughly tested, using 12 temperature sensors and the latest instruments to obtain validation, which corresponds to international standards.

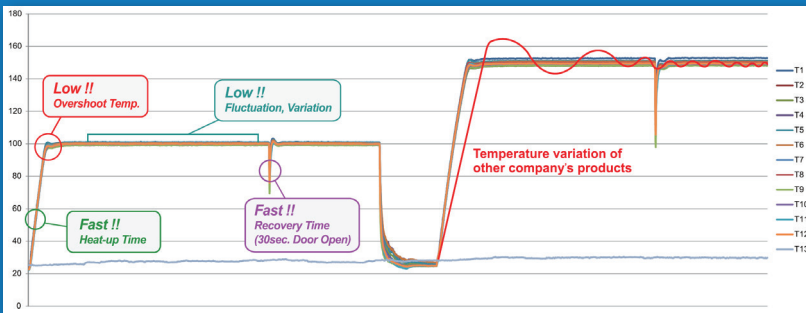

Green product

All incubators and ovens achieve minimum power consumption by using heating elements consuming minimum power adjusted for the capacity and temperature of the chamber.

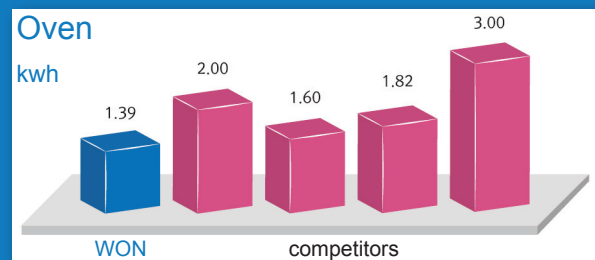
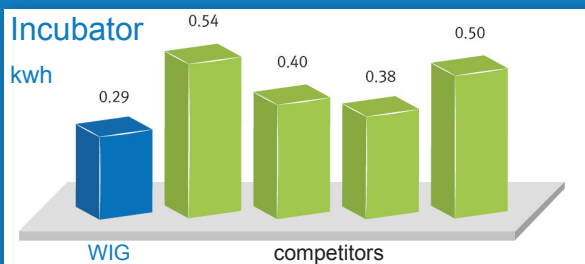

Incubator air-flow

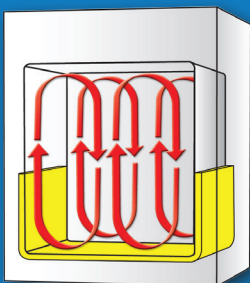

Gravity-air

The incubators gravity-air flow is established by creating radiant and conductive heat on three sides of the chamber (bottom, left and right side).

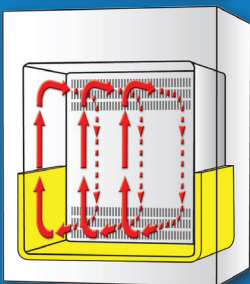

Forced-air

The incubators forced-air flow is established by a three sided heating element in combination with a very effective fan placed in an air-flow room for best temperature uniformity in the whole chamber.

Oven air-flow

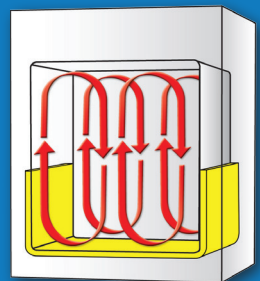

Gravity-air

The ovens gravity-air flow is established by heating up air in a pre-heating zone by heating elements on the bottom, left and right side. The pre-heated air will be restrictively provided into the chamber.

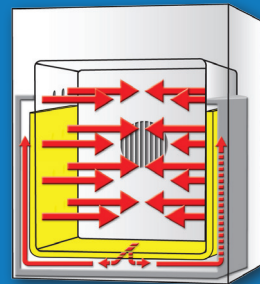

Forced-air

The ovens forced-air flow is established by a very effective fan installed in the rear of the chamber sucking air from the chamber into the pre-heating zone where heating elements on the bottom, left and right side heat up air. The pre-heated air is uniformly and quickly provided into the chamber by a special side and bottom structure.

Incubator | gravity-air

Jog-Dial controller, gravity-air flow, up to 70°C, 32 / 50 / 105 / 155 l



Gravity-air
3-sided heating zone



Wise remote

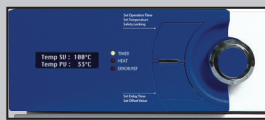

Jog-Dial controller

IQ | OQ
available
page 12 for details



WIG-105 with Jog-Dial controller
and 2x PE-coated steel wire shelves (included)

WIG 70°C, 32 / 50 / 105 / 155 l

Ideal for:

- microorganism culture, animal and plant cell culture, constant temperature, germination, etc.

Features:

- gravity-air flow preventing cross contamination of samples
- temperature uniformity and accuracy by high performance 3-sided heating mechanism
- 2x PE-coated steel wire shelves included
- ambient to 70°C of temperature range, fluctuation of $\pm 0.2^\circ\text{C}$ at 37°C, $\pm 0.3^\circ\text{C}$ at 50°C
- corrosion resistant stainless steel chamber, powder-coated body
- inner tempered glass door with silicone packing offers easy observation without door opening
- controller software can be upgraded through USB port
- RS232C interface for monitoring and controlling (WireRemote)
- storage function for the set values of temperature and timer
- alarm function: error status and timer end
- backlight LCD display
- CE & UL/CUL certified and unique serial number for tracing

Safety mechanism:

- overheat and over-current protection
- sensor error detection and locking mode

Controller:

- **Jog-Dial controller (PID)** with 2-way knob (turn and push), digital LCD with backlight, and two durable setting buttons

Model	WIG-32	WIG-50	WIG-105	WIG-155
Capacity	32 l	50 l	105 l	155 l
Temperature range & control resolution	room temperature +5°C - +70°C, $\pm 0.1^\circ\text{C}$			
Temperature fluctuation & sensor	$\pm 0.2^\circ\text{C}$ at 37°C, $\pm 0.3^\circ\text{C}$ at 50°C, PT 100 sensor			
Temperature variation	$\pm 0.6^\circ\text{C}$ at 37°C, $\pm 1.0^\circ\text{C}$ at 50°C			
Heater power	150 W	200 W	300 W	400 W
Heat-up time	25 min to 37°C, 40 min to 50°C			30 min to 37°C, 40 min to 50°C
Recovery time (door open 30sec)	8 min to 37°C, 12 min to 50°C		10 min to 37°C, 15 min to 50°C	
Timer & alarm	99hr 59 min (delay & continuous run)			
Shelves	2 x PE-coated steel wire shelves included, total load 32 kg (16 kg per shelf)			
Ventilation hole	1 ventilation hole (inner \varnothing 35 mm) with stainless steel cap			
Internal dimensions (W x D x H, mm)	312 x 290 x 360 mm	370 x 350 x 420 mm	485 x 410 x 535 mm	550 x 475 x 600 mm
External dimensions (W x D x H, mm), net weight	458 x 477 x 624 mm, 32 kg	518 x 537 x 701 mm, 40 kg	635 x 595 x 841 mm, 59 kg	700 x 660 x 906 mm, 71 kg
Packing size & gross weight	568 x 592 x 698 mm, 39 kg	628 x 652 x 775 mm, 53 kg	731 x 710 x 1018 mm, 67 kg	796 x 775 x 1083 mm, 78 kg
Power supply	1 Phase AC 120V, 60 Hz or AC 230V, 50/60 Hz			
Power consumption	159 W	169,9 W	292,9 W	420,5 W
Energy consumption at 37°C/ at 50°C	34 Wh/ 81 Wh	41 Wh/103 Wh	63 Wh/ 152 Wh	99 Wh/ 212 Wh
Order number 230V	DH.WIG03032	DH.WIG03050	DH.WIG03105	DH.WIG03155
Order number 120V	DH.WIG04032	DH.WIG04050	DH.WIG04105	DH.WIG04155

Accessories: Suitable stainless steel and PE-coated shelves can be found on page 65

Incubator | gravity-air

SMART-Lab™ controller, gravity-air flow, up to 70°C, 32 / 50 / 105 / 155 l

SWIG 70°C, 32 / 50 / 105 / 155 l

Ideal for:

- microorganism culture, animal and plant cell culture, constant temperature, germination, etc.

Features:

- gravity-air flow by natural flow preventing cross contamination of samples
- temperature uniformity and accuracy by high performance 3-sided heating mechanism
- 2x PE-coated steel wire shelves included
- corrosion resistant stainless steel chamber, powder-coated body
- inner tempered glass door with silicone packing offers easy observation without door opening
- ambient to 70°C of temperature range, fluctuation of $\pm 0.2^\circ\text{C}$ at 37°C, $\pm 0.3^\circ\text{C}$ at 50°C
- storage function for the set values of temperature and timer
- alarm function: error status and timer end
- CE & UL/CUL certified and unique serial number for tracing

Safety mechanism:

- overheat and over-current protection
- sensor error detection

Controller:

- **Smart-Lab™ controller** with 4" full touch screen TFT LCD:
 - ◆ WiRe™ app service, remote control system
 - ◆ variable program settings
 - ◆ self-diagnostic function
 - ◆ automatic data recording
 - ◆ data transfer to PC by USB memory
 - ◆ Internet connectivity with WiFi

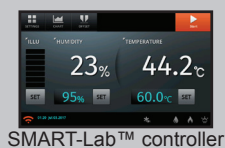

IQ | OQ
available
page 12 for details



SWIG-105 with SMART-Lab controller and 2x PE-coated steel wire shelves (included)

Model	SWIG-32	SWIG-50	SWIG-105	WIG-155
Capacity	32 l	50 l	105 l	155 l
Temperature range & control resolution	room temperature +5°C - +70°C, $\pm 0.1^\circ\text{C}$			
Temperature fluctuation & sensor	$\pm 0.2^\circ\text{C}$ at 37°C, $\pm 0.3^\circ\text{C}$ at 50°C, PT 100 sensor			
Temperature variation	$\pm 0.6^\circ\text{C}$ at 37°C, $\pm 1.0^\circ\text{C}$ at 50°C			
Heater power	150 W	200 W	300 W	400 W
Heat-up time	25 min to 37°C, 40 min to 50°C			30 min to 37°C, 40 min to 50°C
Recovery time (door open 30sec)	8 min to 37°C, 12 min to 50°C		10 min to 37°C, 15 min to 50°C	
Timer & alarm	99hr 59 min (delay & continuous run)			
Shelves	2 x PE-coated steel wire shelves included, total load 32 kg (16 kg per shelf)			
Ventilation hole	1 ventilation hole (inner \varnothing 35 mm) with stainless steel cap			
Internal dimensions (W x D x H, mm)	312 x 290 x 360 mm	370 x 350 x 420 mm	485 x 410 x 535 mm	550 x 475 x 600 mm
External dimensions (W x D x H, mm), net weight	458 x 477 x 624 mm, 32 kg	518 x 537 x 701 mm, 40 kg	635 x 595 x 841 mm, 59 kg	700 x 660 x 906 mm, 71 kg
Packing size & gross weight	568 x 592 x 698 mm, 39 kg	628 x 652 x 775 mm, 53 kg	731 x 710 x 1018 mm, 67 kg	796 x 775 x 1083 mm, 78 kg
Power supply	1 Phase AC 120V, 60 Hz or AC 230V, 50/60 Hz			
Power consumption	159 W	169,9 W	292,9 W	420,5 W
Energy consumption at 37°C/ at 50°C	34 Wh/ 81 Wh	41 Wh/103 Wh	63 Wh/ 152 Wh	99 Wh/ 212 Wh
Order number 230V	DH.SWIG03032	DH.SWIG03050	DH.SWIG03105	DH.SWIG03155
Order number 120V	DH.SWIG04032	DH.SWIG04050	DH.SWIG04105	DH.SWIG04155

Accessories: Suitable stainless steel and PE-coated shelves can be found on page 65

Incubator | forced-air

Jog-Dial controller, forced-air convection, up to 70°C, 50 / 105 / 155 l

WIF 70°C, 50/105/155 l

Ideal for:

- microorganism culture, animal and plant cell culture, constant temperature, germination, etc.

Features:

- optimized air flow by forced-air mechanism
- temperature uniformity and accuracy by high performance 3-sided heating mechanism
- 2x PE-coated steel wire shelves included
- ambient to 70°C of temperature range, accuracy of $\pm 0.2^\circ\text{C}$ at 37°C, $\pm 0.3^\circ\text{C}$ at 50°C
- corrosion resistant stainless steel chamber, powder-coated body
- inner tempered glass door with silicone packing offers easy observation without door opening
- RS232C interface for monitoring and controlling (WireRemote) storage function for the set values of temperature and timer
- alarm function: error status and timer end
- backlight LCD display
- CE & UL/CUL certified and unique serial number for tracing

Safety mechanism:

- overheat and over-current protection
- sensor error detection and locking mode

Controller:

- **Jog-Dial controller (PID)** with 2-way knob (turn and push), digital LCD with backlight, and two durable setting buttons

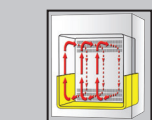

Forced-air
3-sided heating zone



Wise remote

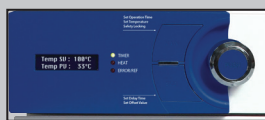

Jog-Dial controller

IQ | OQ
available
page 12 for details



WIF-105 with Jog-Dial controller
and 2x PE-coated steel wire shelves (included)

Model	WIF-50	WIF-105	WIF-155
Capacity	50 l	105 l	155 l
Temperature range & control resolution	room temperature +5°C - +70°C, $\pm 0.1^\circ\text{C}$		
Temperature fluctuation & sensor	$\pm 0.2^\circ\text{C}$ at 37°C, $\pm 0.3^\circ\text{C}$ at 50°C, PT 100 sensor		
Temperature variation	$\pm 0.5^\circ\text{C}$ at 37°C $\pm 0.9^\circ\text{C}$ at 50°C	$\pm 0.4^\circ\text{C}$ at 37°C $\pm 0.7^\circ\text{C}$ at 50°C	
Heater power	200 W	300 W	400 W
Heat-up time	17 min to 37°C, 28 min to 50°C	17 min to 37°C, 30 min to 50°C	
Recovery time (door open 30sec)	3 min to 37°C, 4 min to 50°C		
Timer & alarm	99hr 59 min (delay & continuous run)		
Shelves	2 x PE-coated steel wire shelves included, total load 32 kg (16 kg per shelf)		
Ventilation hole	1 ventilation hole (inner \varnothing 35 mm) with stainless steel cap		
Internal dimensions (W x D x H)	370 x 350 x 419 mm	485 x 410 x 533 mm	550 x 475 x 600 mm
External dimensions (W x D x H), net weight	518 x 637 x 700 mm, 46 kg	635 x 695 x 841 mm, 66 kg	700 x 760 x 906 mm, 81 kg
Packing size & gross weight	628 x 752 x 775 mm, 58 kg	710 x 731 x 1018 mm, 74 kg	731 x 810 x 1018 mm, 92 kg
Power supply	1 Phase AC 120V, 60 Hz or AC 230V, 50/60 Hz		
Power consumption	216,3 W	302,9 W	438,1 W
Energy consumption at 37°C/ at 50°C	28 Wh/ 84 Wh	43 Wh/ 129 Wh	58 Wh/ 145 Wh
Order number 230V	DH.WIF03050	DH.WIF03105	DH.WIF03155
Order number 120V	DH.WIF04050	DH.WIF04105	DH.WIF04155

Accessories: Suitable stainless steel and PE-coated shelves can be found on page 65

Incubator | forced-air

SMART-Lab™ controller, forced-air convection, up to 70°C, 50 / 105 / 155 l

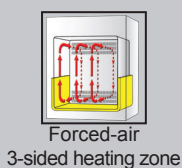

IQ | OQ
available
page 12 for details

SWIF 70°C, 50/105/155 l

Ideal for:

- microorganism culture, animal and plant cell culture, constant temperature, germination, etc.

Features:

- optimized air flow by forced-air mechanism
- temperature uniformity and accuracy by high performance 3-sided heating mechanism
- 2x PE-coated steel wire shelves included
- corrosion resistant stainless steel chamber, powder-coated body
- inner tempered glass door with silicone packing offers easy observation without door opening
- ambient to 70°C of temperature range, accuracy of $\pm 0.2^\circ\text{C}$ at 37°C, $\pm 0.3^\circ\text{C}$ at 50°C
- storage function for the set values of temperature and timer
- alarm function: error status and timer end
- CE & UL/CUL certified and unique serial number for tracing

Safety mechanism:

- overheat and over-current protection
- sensor error detection

Controller:

- **Smart-Lab™ controller** with 4" full touch screen TFT LCD:
 - ◆ WiRe™ app service, remote control system
 - ◆ variable program settings
 - ◆ self-diagnostic function
 - ◆ automatic data recording
 - ◆ data transfer to PC by USB memory
 - ◆ Internet connectivity with WiFi



SWIF-105 with SMART-Lab™ controller and 2x PE-coated steel wire shelves (included)

Model	SWIF-50	SWIF-105	SWIF-155
Capacity	50 l	105 l	155 l
Temperature range & control resolution	room temperature +5°C - +70°C, $\pm 0.1^\circ\text{C}$		
Temperature fluctuation & sensor	$\pm 0.2^\circ\text{C}$ at 37°C, $\pm 0.3^\circ\text{C}$ at 50°C, PT 100 sensor		
Temperature variation	$\pm 0.5^\circ\text{C}$ at 37°C $\pm 0.9^\circ\text{C}$ at 50°C	$\pm 0.4^\circ\text{C}$ at 37°C $\pm 0.7^\circ\text{C}$ at 50°C	
Heater power	200 W	300 W	400 W
Heat-up time	17 min to 37°C, 28 min to 50°C	17 min to 37°C, 30 min to 50°C	
Recovery time (door open 30sec)	3 min to 37°C, 4 min to 50°C		
Timer & alarm	99hr 59 min (delay & continuous run)		
Shelves	2 x PE-coated steel wire shelves included, total load 32 kg (16 kg per shelf)		
Ventilation hole	1 ventilation hole (inner \varnothing 35 mm) with stainless steel cap		
Internal dimensions (W x D x H, mm)	370 x 350 x 419 mm	485 x 410 x 533 mm	550 x 475 x 600 mm
External dimensions (W x D x H, mm), net weight	518 x 637 x 700 mm, 46 kg	635 x 695 x 841 mm, 66 kg	700 x 760 x 906 mm, 81 kg
Packing size & gross weight	628 x 752 x 775 mm, 58 kg	710 x 731 x 1018 mm, 74 kg	731 x 810 x 1018 mm, 92 kg
Power supply	1 Phase AC 120V, 60 Hz or AC 230V, 50/60 Hz		
Power consumption	216,3 W	302,9 W	438,1 W
Energy consumption at 37°C/ at 50°C	28 Wh/ 84 Wh	43 Wh/ 129 Wh	58 Wh/ 145 Wh
Order number 230V	DH.SWIF03050	DH.SWIF03105	DH.SWIF03155
Order number 120V	DH.SWIF04050	DH.SWIF04105	DH.SWIF04155

Accessories: Suitable stainless steel and PE-coated shelves can be found on page 65

Incubator | forced-air | B.O.D.

Jog-Dial controller, forced-air convection, 0°C - 60°C (refrigerated), 150 / 250 / 420 / 700 l

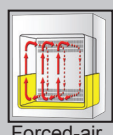

Forced-air



Wise remote

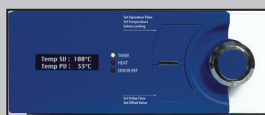

Jog-Dial controller

IQ | OQ
available
page 12 for details



WIR-150 with Jog-Dial controller and 3x PE-coated steel wire shelves (included)

WIR 0-60°C, refrigerated

Ideal for:

- animal and plant cell culture, constant temperature, germination test, BOD test, etc.

Features:

- CFC free refrigerant (R-404A)
- intelligent refrigerator control prevents compressor overload
- superior temperature uniformity by forced-air convection
- stainless steel chamber, powder-coated body
- tempered glass door to observe samples during incubation
- 3x PE-coated steel wire shelves included
- RS232C interface for monitoring and controlling (WireRemote)
- storage function for set values: alarm and temperature
- backlight LCD display
- CE & UL/CUL certified and unique serial number for tracing

Safety mechanism:

- locking mode
- overheat and over-current protection
- sensor error detection and leakage breaker

Controller:

- **Jog-Dial controller (PID)** with 2-way knob (turn and push), digital LCD with backlight, and two durable setting buttons

Model	WIR-150	WIR-250	WIR-420	WIR-700
Capacity	150 l	250 l	420 l	700 l
Temperature range & accuracy	0°C - +60°C, ±0.2°C at 37°C (refrigerated)			
Temperature uniformity & sensor	±0.5°C at 37°C, ±1.4°C at 50°C, PT100 sensor			
Heat-up time	20 min to 37°C, 20 min to 50°C		35 min to 37°C, 35 min to 50°C	
Recovery time (door open 30sec)	10 min to 37°C, 12 min to 50°C		12 min to 37°C, 15 min to 50°C	
Heater power	700 W	1 kW	1.2 kW	2 kW
Compressor	190 W	250 W	370 W	370 W
Timer & alarm	99hr 59 min (delay & continuous run), error status and timer end			
Shelves	3 x PE-coated steel wire shelves included, total load 48 kg (16 kg per shelf)			
Internal dimensions (W x D x H)	505 x 505 x 610 mm	505 x 505 x 1000 mm	705 x 605 x 1000 mm	800 x 700 x 1250 mm
External dimensions (W x D x H), net weight	640 x 832 x 1313 mm, 118 kg	640 x 832 x 1703 mm, 157 kg	840 x 932 x 1753 mm, 202 kg	935 x 1027 x 2000 mm, 234 kg
Packing size & gross weight	900 x 1000 x 1650 mm, 191 kg	900 x 1000 x 2040 mm, 217 kg	1100 x 1100 x 2140 mm, 277 kg	1220 x 1220 x 2260 mm, 313 kg
Power supply	1 Phase AC 120V, 60 Hz or AC 230V, 50/60 Hz			
Power consumption	1,6 kW	1,8 kW	2,3 kW	2,4 kW
Order number 230V	DH.WIR03150	DH.WIR03250	DH.WIR03420	DH.WIR03700
Order number 120V	DH.WIR04150	DH.WIR04250	DH.WIR04420	DH.WIR04700

Accessories: Suitable stainless steel and PE-coated shelves can be found on page 65

Incubator | forced-air | B.O.D.

SMART-Lab™ controller, forced-air convection, 0°C - 60°C (refrigerated), 150 / 250 / 420 / 700 l

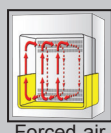

Forced-air



SMART-Lab™ controller



WiRe™ app service

SWIR 0-60°C, refrigerated

Ideal for:

- animal and plant cell culture, constant temperature, germination test, BOD test, etc.

Features:

- CFC free refrigerant (R-404A)
- intelligent refrigerator control prevents compressor overload
- superior temperature uniformity by forced-air convection
- stainless steel chamber, powder-coated body
- tempered glass door to observe samples during incubation
- 3x PE-coated steel wire shelves included
- 0°C - +60°C (refrigerated)
- CE & UL/CUL certified and unique serial number for tracing

Safety mechanism:

- overheat and over-current protection
- sensor error detection and leakage breaker

Controller:

- **Smart-Lab™ controller** with 4" full touch screen TFT LCD:
 - ◆ WiRe™ app service, remote control system
 - ◆ variable program settings
 - ◆ self-diagnostic function
 - ◆ automatic data recording
 - ◆ data transfer to PC by USB memory
 - ◆ Internet connectivity with WiFi

IQ | OQ
available
page 12 for details



SWIR-150 with SMART-Lab™ controller and 3x PE-coated steel wire shelves (included)

Model	SWIR-150	SWIR-250	SWIR-420	SWIR-700
Capacity	150 l	250 l	420 l	700 l
Temperature range & accuracy	0°C - +60°C, ±0.2°C at 37°C (refrigerated)			
Temperature uniformity & sensor	±0.5°C at 37°C, ±1.4°C at 50°C, PT100 sensor			
Heat-up time	20 min to 37°C, 20 min to 50°C		35 min to 37°C, 35 min to 50°C	
Recovery time (door open 30sec)	10 min to 37°C, 12 min to 50°C		12 min to 37°C, 15 min to 50°C	
Heater power	700 W	1 kW	1.2 kW	2 kW
Compressor	190 W	250 W	370 W	370 W
Timer & alarm	99hr 59 min (delay & continuous run), error status and timer end			
Shelves	3 x PE-coated steel wire shelves included, total load 48 kg (16 kg per shelf)			
Internal dimensions (W x D x H)	505 x 505 x 610 mm	505 x 505 x 1000 mm	705 x 605 x 1000 mm	800 x 700 x 1250 mm
External dimensions (W x D x H), net weight	640 x 832 x 1313 mm, 118 kg	640 x 832 x 1703 mm, 157 kg	840 x 932 x 1753 mm, 202 kg	935 x 1027 x 2000 mm, 234 kg
Packing size & gross weight	900 x 1000 x 1650 mm, 191 kg	900 x 1000 x 2040 mm, 217 kg	1100 x 1100 x 2140 mm, 277 kg	1220 x 1220 x 2260 mm, 313 kg
Power supply	1 Phase AC 120V, 60 Hz or AC 230V, 50/60 Hz			
Power consumption	1,6 kW	1,8 kW	2,3 kW	2,4 kW
Order number 230V	DH.SWIR03150	DH.SWIR03250	DH.SWIR03420	DH.SWIR03700
Order number 120V	DH.SWIR04150	DH.SWIR04250	DH.SWIR04420	DH.SWIR04700

Accessories: Suitable stainless steel and PE-coated shelves can be found on page 65

Incubator | forced-air

Jog-Shuttle controller, forced-air convection, 4 chambers à 125 l, up to 70°C or 0 - 70°C

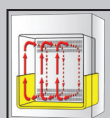

Forced-air

4 individual chambers



Jog-Shuttle controller

IQ | OQ
available
page 12 for details

WIM 70°C / 0 - 70°C, 4x 125 l

Ideal for:

- microorganism culture, animal and plant cell culture, constant temperature, germination, etc.

Features:

- forced-air flow by silent fan motor implements the highest uniformity of temperature in each chamber
- 4x125 liter chambers
- each chamber has an independent fuzzy controller for different temperature and time control
- 8x PE-coated steel wire shelves included
- corrosion resistant stainless steel chamber, powder-coated body
- tempered glass door to observe samples during incubation
- storage function for the set values of temperature and timer
- backlight LCD display
- CE & UL/CUL certified and unique serial number for tracing

Safety mechanism:

- locking mode
- overheat and over-current protection
- sensor error detection

Controller:

- digital fuzzy controller with **Jog-Shuttle-switch** (turn + push)



WIM-R4 with Jog-Shuttle controller and 8x PE-coated steel shelves (included)

Model	WIM-4	WIM-R4	WIM-RL4
Capacity	4 rooms x 125 l		
Illumination	none		2 x FRL 55 W (x 4 rooms)
Compressor	none		1/4 HP (4 x rooms)
Temperature range	room temperature +5°C - 70°C	0°C - 60°C (refrigerated)	
Temperature accuracy & sensor	±0.2°C at 37°C, PT 100 sensor		
Temperature uniformity	±0.3°C at 37°C, ±0.7°C at 50°C	±0.5°C at 37°C	
Heating power	4 x 500 W	4 x 650 W	
Heat-up time	15 min to 37°C, 30 min to 50°C	20 min to 37°C, 30 min to 50°C	
Recovery time (door open 30sec)	8 min to 37°C, 10 min to 50°C	10 min to 37°C, 12 min to 50°C	
Timer & alarm	99hr 59 min (delay & continuous run), error status and timer end		
Internal dimensions (W x D x H)	500 x 500 x 500 mm (each room)		
External dimensions (W x D x H), net weight	1655 x 845 x 1710 mm, 343 kg	1655 x 845 x 1710 mm, 350 kg	
Packing size & gross weight	1900 x 1050 x 1950 mm, 441 kg	1900 x 1050 x 1950 mm, 450 kg	
Power supply	1 Phase AC 120V, 60 Hz or AC 230V, 50/60 Hz	3 Phase AC 400V, 50/60 Hz	
Power consumption	2,6 kW	4,5 kW	4,8 kW
Order number 230V	DH.WIM04125	DH.WIM14125*	DH.WIM24125*
Order number 120V	DH.WIM05125	DH.WIM15125*	DH.WIM25125*
Order number 3 Phase	-	DH.WIM16125	DH.WIM26125

* models not available in Europe

Accessories: Suitable stainless steel and PE-coated shelves can be found on page 65

PE-coated shelves, steel wire

- suitable for incubators **WIF, SWIF, WIG, SWIG**
- two ledges for assembling included

For device...	Measurements	Article	Order number
WIG-32 / SWIG-32	280 x 260 mm	IGS032	DH.WIG11032
WIG-50 / SWIG-50 WIF-50 / SWIF-50	340 x 310 mm	IGS050	DH.WIG11050
WIG-105 / SWIG-105 WIF-105 / SWIF-105	455 x 375 mm	IGS105	DH.WIG11105
WIG-155 / SWIG-155 WIF-155 / SWIF-155	520 x 440 mm	IGS155	DH.WIG11155

Stainless steel shelves

- suitable for incubators **WIF, SWIF, WIG, SWIG**
- two ledges for assembling included

For device...	Measurements	Article	Order number
WIG-32 / SWIG-32	280 x 260 mm	IGSN032	DH.WIG12032
WIG-50 / SWIG-50 WIF-50 / SWIF-50	340 x 310 mm	ONS050	DH.WON11050
WIG-105 / SWIG-105 WIF-105 / SWIF-105	455 x 375 mm	ONS105	DH.WON11105
WIG-155 / SWIG-155 WIF-155 / SWIF-155	520 x 440 mm	ONS155	DH.WON11155

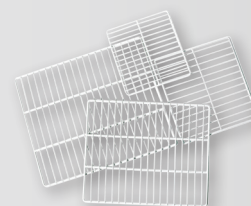

WIF | SWIF | WIG | SWIG

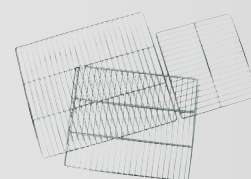

PE-coated shelves, steel wire

- suitable for incubators **WIR, SWIR**
- two ledges for assembling included

For device...	Measurements	Article	Order number
WIR-150 / SWIR-150 WIR-250 / SWIR-250	470 x 480 mm	IRS150	DH.WIR11150
WIR-420 / SWIR-420	675 x 585 mm	IRS420	DH.WIR11420
WIR-700 / SWIR-700	770 x 680 mm	IRS700	DH.WIR11700

Stainless steel shelves

- suitable for incubators **WIR, SWIR**
- two ledges for assembling included

For device...	Measurements	Article	Order number
WIR-150 / SWIR-150 WIR-250 / SWIR-250	470 x 480 mm	IRU150	DH.WIR21150
WIR-420 / SWIR-420	675 x 585 mm	IRU420	DH.WIR21420
WIR-700 / SWIR-700	770 x 680 mm	IRU700	DH.WIR21700

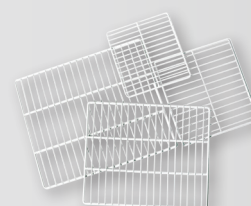

WIR | SWIR

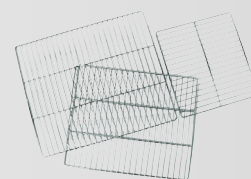

PE-coated shelves, steel wire

- suitable for incubators **WIM**
- two ledges for assembling included

For device...	Measurements	Article	Order number
all WIM models	470 x 480 mm	IMS125	DH.WIM034125

Stainless steel shelves

- suitable for incubators **WIM**
- two ledges for assembling included

For device...	Measurements	Article	Order number
all WIM models	470 x 480 mm	IMS126	DH.WIM034126

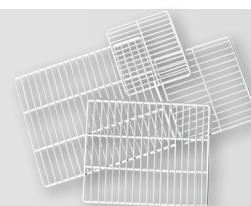

WIM

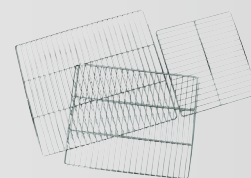

Incubator | shaking

front door-type, up to 60°C / 10°C - 60°C (refrigerated), 30-250 rpm, orbital motion



Orbital motion



Wise remote



Jog-Shuttle controller

IQ | OQ
available
page 12 for details



WIS-30 with universal platform (included)

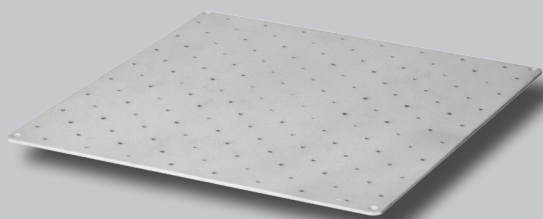

WIS-30 front door, 60°C, orbital

Ideal for:

- biological cultures under various temperatures

Features:

- front door and sliding platform provides easy loading and handling of samples
- RS232C interface for monitoring and controlling (WireRemote)
- advanced shaking mechanism provides quiet shaking and precise speed control
- stabilized orbital motion, minimum noise and no vibration
- universal platform included
- accommodates flasks up to 1000 ml
- durable and flexible plastic flask holder (optional)
- universal spring rack for various flask shapes/sizes (optional)
- stainless steel interior and powder-coated body
- backlight LCD display
- CE certified and unique serial number for tracing

Safety mechanism:

- overheat and over-current protection
- leakage breaker
- automatic operation stop when door opens

Controller:

- digital fuzzy controller with **Jog-Shuttle-switch** (turn + push)

Model	WIS-30	WIS-30R
Temperature range	room temperature +5°C - 60°C	10°C - 60°C (refrigerated)
Temperature accuracy & uniformity	accuracy: ±0.2°C at 37°C, uniformity: ±0.5°C at 37°C	
Temperature sensor	PT100 sensor	
Heater	600 W	800 W
Compressor	none	190 W
Compressor control	none	refrigerator control for preventing overload
Refrigerant	none	CFC-free (134A) refrigeration system
Shaking speed & stroke	30 - 250 rpm, 25 mm orbital motion	
Timer & alarm	99hr 59 min (delay & continuous run), error status and timer end	
Max. capacity of flask holder 50-100 ml	35 pcs. flask holder for 50 - 100 ml flasks	
Max. capacity of flask holder 200-300 ml	16 pcs. flask holder for 200 - 300 ml flasks	
Max. capacity of flask holder 500 - 1000 ml	12 pcs. flask holder for 500 - 1000 ml flasks	
Internal dimensions (W x D x H)	570 x 465 x 470 mm	
External dimensions (W x D x H)	916 x 730 x 683 mm	
Packing size & gross weight	1050 x 900 x 900 mm, 146 kg	1050 x 900 x 900 mm, 156 kg
Power supply	1 Phase AC 120V, 60 Hz or AC 230V, 50/60 Hz	
Power consumption	600 W	1,3 kW
Order number 230V	DH.WIS00230	DH.WIS01230
Order number 120V	DH.WIS00130	DH.WIS01130

Accessories: Suitable platforms, racks and flask holder can be found on page 73

Incubator | shaking

bench top-type, up to 60°C / 10°C - 60°C (refrigerated), 30-250 rpm, orbital motion



Orbital motion



Wise remote



Jog-Shuttle controller

IQ | OQ
available
page 12 for details

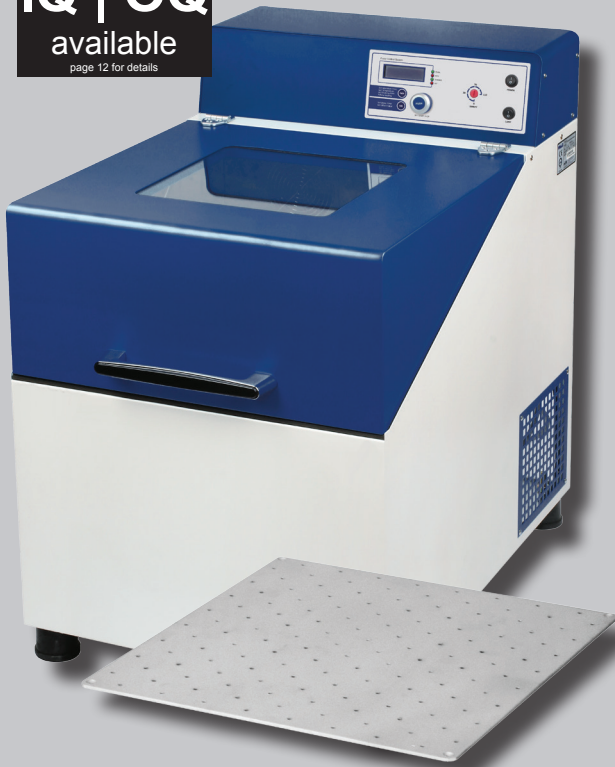

WIS-20 with universal platform (included)

WIS-20 bench top, 60°C, orbital

Ideal for:

- biological cultures under various temperatures

Features:

- easy access to bench top by liftable door
- RS232C interface for monitoring and controlling (WireRemote)
- advanced shaking mechanism provides quiet shaking and precise speed control
- stabilized orbital motion, minimum noise and no vibration
- 60W krypton lamp
- universal platform included
- accommodates flasks up to 1000 ml
- durable and flexible plastic flask holder (optional)
- universal spring rack for various flask shapes/sizes (optional)
- stainless steel interior and powder-coated body
- backlight LCD display
- CE certified and unique serial number for tracing

Safety mechanism:

- overheat and over-current protection
- sensor error detection and leakage breaker
- automatic operation stop when door opens

Controller:

- digital fuzzy controller with **Jog-Shuttle-switch** (turn + push)

Model	WIS-20	WIS-20R
Temperature range	room temperature +5°C - 60°C	10°C - 60°C (refrigerated)
Temperature accuracy & uniformity	accuracy: ±0.2°C at 37°C, uniformity: ±0.5°C at 37°C	
Temperature sensor	PT100 sensor	
Heater	500 W	700 W
Compressor	none	190 W
Compressor control	none	refrigerator control for preventing overload
Refrigerant	none	CFC-free (134A) refrigeration system
Shaking speed & stroke	30 - 250 rpm, 25 mm orbital motion	
Timer & alarm	99hr 59 min (delay & continuous run), error status and timer end	
Max. capacity of flask holder 50-100 ml	32 pcs. flask holder for 50 - 100 ml flasks	
Max. capacity of flask holder 200-300 ml	20 pcs. flask holder for 200 - 300 ml flasks	
Max. capacity of flask holder 500 - 1000 ml	16 pcs. flask holder for 500 - 1000 ml flasks	
Internal dimensions (W x D x H)	530 x 530 x 350 mm	
External dimensions (W x D x H), net weight	575 x 855 x 850 mm	
Packing size & gross weight	1000 x 800 x 1100 mm, 147 kg	1000 x 800 x 1100 mm, 150 kg
Power supply	1 Phase AC 120V, 60 Hz or AC 230V, 50/60 Hz	
Power consumption	500 W	1,2 kW
Order number 230V	DH.WIS00220	DH.WIS01220
Order number 120V	DH.WIS00120	DH.WIS01120

Accessories: Suitable platforms, racks and flask holder can be found on page 73

Incubator | shaking

top door-type, up to 60°C / 10°C - 60°C (refrigerated), 30-250 rpm, orbital motion



Orbital motion



Wise remote



Jog-Shuttle controller

IQ | OQ
available
page 12 for details

WIS-10 top door, 60°C, orbital

Ideal for:

- biological cultures under various temperatures

Features:

- CFC free refrigerant (R-404A)
- easy access to bench top by liftable door
- RS232C interface for monitoring and controlling (WireRemote)
- advanced shaking mechanism provides quiet shaking and precise speed control
- stabilized orbital motion, minimum noise and no vibration
- 60W krypton lamp (WIS-10RL)
- universal platform included
- accommodates flasks up to 1000 ml
- durable and flexible plastic flask holder (optional)
- universal spring rack for various flask shapes/sizes (optional)
- stainless steel interior and powder-coated body
- backlight LCD display
- CE certified and unique serial number for tracing

Safety mechanism:

- overheat and over-current protection
- sensor error detection and leakage breaker
- automatic operation stop when door opens

Controller:

- digital fuzzy controller with **Jog-Shuttle-switch** (turn + push)

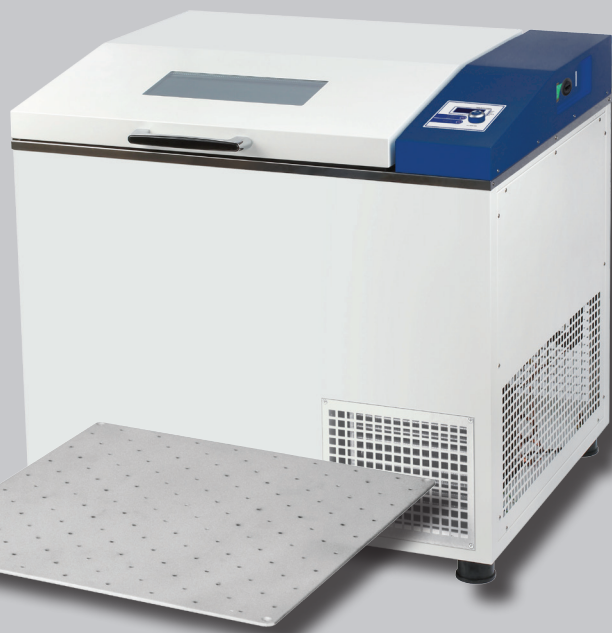

WIS-10 with universal platform (included)

Model	WIS-10	WIS-10R	WIS-10RL
Temperature range	R/T +5°C - 60°C	+10°C - 60°C (refrigerated)	
Temperature accuracy & uniformity	accuracy: ±0.2°C at 37°C, uniformity: ±0.5°C at 37°C		
Temperature sensor	PT100 sensor		
Heater	800 W	1 kW	1.2 kW
Compressor	none	250 W	
Compressor control	none	refrigerator control for preventing overload	
Shaking speed & stroke	30 - 250 rpm, 25 mm orbital motion		
Timer & alarm	99hr 59 min (delay & continuous run), error status and timer end		
Room lamp	-	Krypton lamp, 60 W	
Max. capacity of flask holder 50-100 ml	68 pcs. flask holder for 50 - 100 ml flasks		
Max. capacity of flask holder 200-300 ml	36 pcs. flask holder for 200 - 300 ml flasks		
Max. capacity of flask holder 500 - 1000 ml	21 pcs. flask holder for 500 - 1000 ml flasks		
Internal dimensions (W x D x H)	750 x 720 x 400 mm		
External dimensions (W x D x H)	1065 x 900 x 980 mm		
Packing size & gross weight	1220 x 1060 x 1200 mm, 231 kg	1220 x 1060 x 1200 mm, 238 kg	1220 x 1060 x 1200 mm, 238 kg
Power supply	1 Phase AC 120V, 60 Hz or AC 230V, 50/60 Hz		
Power consumption	800 W	1,8 kW	2,1 kW
Order number 230V	DH.WIS00210	DH.WIS04210	DH.WIS05210
Order number 120V	DH.WIS00110	DH.WIS04110	DH.WIS05110

Accessories: Suitable platforms, racks and flask holder can be found on page 73

Incubator | shaking

multi-stack, 10°C - 60°C (refrigerated), 30-250 rpm, orbital motion



Orbital motion



Wise remote



2/4 independent Jog-Shuttle controller

IQ | OQ
available
page 12 for details



WIS-ML04 with 4x universal platforms (included)

WIS-ML multi-stack, 10-60°C, orbital

Ideal for:

- multi-use and wide range of sample testing under various temperature

Features:

- space saving design for large quantity samples with 2 or 4 independent shaking speed controller
- CFC free refrigerant (R-404A)
- control of refrigerator for preventing compressor overload
- advanced shaking mechanism provides quiet shaking and precise speed control
- RS232C interface for monitoring and controlling (WireRemote)
- durable and flexible plastic flask holder(optional)
- universal platforms included (2 or 4 according to model)
- magnetic packing door with pair glass, stainless steel interior and powder-coated body
- backlight LCD display
- CE certified and unique serial number for tracing

Safety mechanism:

- overheat and over-current protection
- sensor error detection
- automatic operation stop when door opens

Controller:

- digital fuzzy controller with **Jog-Shuttle-switch** (turn + push)

Model	WIS-ML02	WIS-ML04
Shaking stacks	2 stacks	4 stacks
Temperature range & accuracy	+10°C - 60°C, ±0.2°C at 37°C (refrigerated)	
Temperature uniformity & sensor	±1.0°C at 37°C, PT100 sensor	
Heater	1.5 kW	1.8 kW
Compressor	370 W	560 W
Shaking speed & stroke	30 - 250 rpm, 25 mm orbital motion	
Timer & alarm	99hr 59 min (delay & continuous run), error status and timer end	
Plate size	W 700 x D 600 mm	
Max. capacity of flask holder 50-100 ml	68 pcs. flask holder for 50 - 100 ml flasks (per platform)	
Max. capacity of flask holder 200-300 ml	36 pcs. flask holder for 200 - 300 ml flasks (per platform)	
Max. capacity of flask holder 500 - 1000 ml	21 pcs. flask holder for 500 - 1000 ml flasks (per platform)	
Internal dimensions (W x D x H)	700 x 700 x 1100 mm	700 x 700 x 1790 mm
External dimensions (W x D x H)	1290 x 850 x 1445 mm	1290 x 850 x 2125 mm
Packing size & gross weight	1500 x 1200 x 1750 mm, 397 kg	1500 x 1200 x 2350 mm, 555 kg
Power supply	1 Phase AC 120V, 60 Hz or AC 230V, 50/60 Hz	3 Phase AC 400V, 50/60 Hz
Power consumption	2,4 kW	3,2 kW
Order number 230V*	DH.WIS05002	DH.WIS05004
Order number 120V*	DH.WIS05102	DH.WIS05104
Order number 3 Phase	-	DH.WIS03004

* 230V and 120V models not available in Europe

Accessories: Suitable platforms, racks and flask holder can be found on page 73

Incubator | growth chamber

NEW

Smart-Lab™ controller, -20°C/-40°C up to 100°C, up to 98% relative humidity

98% RH
-20/-40°C
100°C



STH -20/-40°C, 98% rel. hum.

Ideal for:

- growth of organisms, stability and endurance testing of materials

Features:

- CFC free refrigerant (R-404A) and automatic defrost system
- powerful and silent dual fan motor
- electronic humidity sensor
- large viewing window with membrane heating element (moisture proof)
- sliding water supply tank: auto water supplementing system
- stainless steel interior and powder-coated steel body
- 3x perforated stainless steel shelves included
- CE certified and unique serial number for tracing

Safety mechanism:

- push alarm service to your smartphone
- overheat and over-current protection
- sensor error detection and leakage breaker
- low water level alarm lamp
- door ajar and power failure alarm

Controller:

- **Smart-Lab™ controller** with 7" full touch screen TFT LCD:
 - ◆ WiRe™ app service, remote control system
 - ◆ variable program settings
 - ◆ self-diagnosis and interactive temperature graph
 - ◆ automatic data recording and password protection
 - ◆ data transfer to PC by USB memory
 - ◆ digital calibration (offset function)
 - ◆ min-/max-temperature memory & program function

IQ | OQ
available
page 12 for details



STH-155 with 3x perforated platforms (included)

Model	STH-155	STH-L155	STH-305	STH-L305	STH-420	STH-L420	STH-800	STH-L800
Capacity	155 l		305 l		420 l		800 l	
Temperature & humidity range	-20°C - 100°C, 30% - 98% RH	-40°C - 100°C, 30% - 98% RH	-20°C - 100°C, 30% - 98% RH	-40°C - 100°C, 30% - 98% RH	-20°C - 100°C, 30% - 98% RH	-40°C - 100°C, 30% - 98% RH	-20°C - 100°C, 30% - 98% RH	-40°C - 100°C, 30% - 98% RH
Compressor	7/8 HP	1.5 HP	1.5 HP	2 HP	1.5 HP	3HP	3 HP	4 HP
Heater for temperature	1.5 kW	1.5 kW	2.0 kW	2.0 kW	2.2 kW	2.2 kW	2.5 kW	2.5 kW
Heater for humidity	2.0 kW	2.0 kW	3.0 kW	2.0 kW	3.0 kW	3.0 kW	3.0 kW	3.0 kW
Temp. accu. & stability	±0.3°C, ±0.3°C							
Hum. accu. & stability	±0.3% RH, ±0.3% RH at 70%							
Heat-up/cool-down time	35 min (-20°C to 80°C)/45 min (+20°C to -20°C)							
Sensor	PT100 & capacitive sensor							
Internal dimensions (W x D x H)	505 x 505 x 610 mm		620 x 620 x 800 mm		700 x 700 x 820 mm		1000 x 800 x 1000 mm	
External dimensions (W x D x H), net weight	1100x960x1550 mm		1310x1080x1765 mm		1390x1135x1695 mm		1570x1245x2060 mm	
Packing size & gross weight	1340x1160x1750 mm 290 kg		1520x1250x2080 mm 369 kg		1600x1300x2020 mm 478 kg		1780x1410x2370 mm 678 kg	
Power supply	1 Phase AC 120V, 60 Hz or AC 230V, 50/60 Hz or 3 Phase							
Power consumption	4,7 kW	6,2 kW	5,7 kW	7,9 kW	6,3 kW	9,9 kW	9 kW	12,7 kW
Order number 230V*	DH.STH01155	DH.STH02155	DH.STH01305	DH.STH02305	DH.STH01420	DH.STH02420	DH.STH01800	DH.STH02800
Order number 120V*	DH.STH05155	DH.STH06155	DH.STH05305	DH.STH06305	DH.STH05420	DH.STH06420	DH.STH05800	DH.STH06800
Order number 3 Phase	DH.STH07155	DH.STH08155	DH.STH07305	DH.STH08305	DH.STH07420	DH.STH08420	DH.STH07800	DH.STH08800

* 230V and 120V models not available in Europe

Accessories: Suitable platforms and temperature recorder can be found on page 73

NEW

Incubator | growth chamber

Smart-Lab™ controller, -20°C up to +80°C, up to 95° relative humidity

95% RH
-20°C
80°C

SMART-Lab™ controller



WiRe™ app service

STH-E -20°C, 95% rel. hum.

Ideal for:

- growth of organisms, stability and endurance testing of materials

Features:

- economical and practical type
- CFC free refrigerant (R-404A) and automatic defrost system
- powerful and silent dual fan motor
- inner tempered glass door with silicone packing offers easy observation without door opening
- stainless steel interior and powder-coated steel body
- 3x perforated stainless steel shelves included
- CE certified and unique serial number for tracing

Safety mechanism:

- push alarm service to your smartphone
- overheat and over-current protection
- sensor error detection and leakage breaker
- low water level alarm lamp
- high-low temperature protection
- door ajar and power failure alarm

Controller:

- **Smart-Lab™ controller** with 7" full touch screen TFT LCD:
 - ◆ WiRe™ app service, remote control system
 - ◆ variable program settings
 - ◆ self-diagnosis and interactive temperature graph
 - ◆ automatic data recording and password protection
 - ◆ data transfer to PC by USB memory
 - ◆ digital calibration (offset function)
 - ◆ min-/max-temperature memory & program function

IQ | OQ
available
page 12 for details

STH-E155 with 3x perforated platforms (included)

Model	STH-E155	STH-E305	STH-E420	STH-E800
Capacity	155 l	305 l	420 l	800 l
Temperature range & accuracy	-20°C - +80°C, ±0.3°C (stability ±1.0°C)			
Humidity range & accuracy	30% - 95% RH, ±2% (stability ±3% RH)			
Compressor	7/8 HP	1.5 HP	1.5 HP	3 HP
Heater for temperature	1.5 kW	2.0 kW	2.2 kW	2.5 kW
Heater for humidity	2.0 kW	3.0 kW	3.0 kW	3.0 kW
Sensor	PT100 & capacitive sensor			
Internal dimensions (W x D x H)	505 x 505 x 610 mm	620 x 620 x 800 mm	750 x 660 x 860 mm	1000 x 800 x 1000 mm
External dimensions (W x D x H), net weight	745 x 920 x 1645 mm 290 kg	820 x 1290 x 1720 mm 309 kg	990 x 1075 x 1885 mm 378 kg	1200 x 1100 x 1920 mm 558 kg
Packing size & gross weight	990x1120x1850 mm 355 kg	1220x1220x2050 mm 369 kg	1800x1800x2160 mm 478 kg	1490x1320x2200 mm 678 kg
Power supply	1 Phase AC 120V, 60 Hz or AC 230V, 50/60 Hz or 3 Phase			
Power consumption	4,4 kW	5,7 kW	6,3 kW	8,2 kW
Order number 230V*	DH.STHE0155	DH.STHE0305	DH.STHE0420	DH.STHE0800
Order number 120V*	DH.STHE4155	DH.STHE4305	DH.STHE4420	DH.STHE4800
Order number 3 Phase	DH.STHE5155	DH.STHE5305	DH.STHE5420	DH.STHE5800

* 230V and 120V models not available in Europe

Accessories: Suitable platforms and temperature recorder can be found on page 73

Incubator | growth chamber

Smart-Lab controller, 0-12,000/15,000 Lux, 10°C - 60°C (refrigerated), up to 95% relative humidity

95% RH
10-60°C
Illumination



SMART-Lab™ controller



WiRe™ app service

SWGC Illumination, 95% rel. hum.

Ideal for:

- growth of organisms and plants, stability and endurance testing of materials, environmental simulations
- stability product self-life QC testing

Features:

- CFC free refrigerant (R-404A)
- 3-sided light bank system: intensity of light is controlled by 8 levels and displayed on LCD
- inner tempered glass door with silicone packing offers easy observation without door opening
- PE-coated wire shelves included (4 or 8 acc. to model)
- 3-sided magnetic doors with light banks
- stainless steel interior and powder-coated body
- CE certified and unique serial number for tracing

Safety mechanism:

- push alarm service to your smartphone
- overheat and over-current protection
- sensor error detection and leakage breaker

Controller:

- **Smart-Lab™ controller** with 7" full touch screen TFT LCD:
 - ◆ WiRe™ app service, remote control system
 - ◆ variable program settings
 - ◆ self-diagnosis and interactive temperature graph
 - ◆ automatic data recording and password protection
 - ◆ data transfer to PC by USB memory
 - ◆ digital calibration (offset function)
 - ◆ min-/max-temperature memory & program function

IQ | OQ
available
page 12 for details



SWGC-450, with illumination and 4x PE-coated wire shelves

Model	SWGC-450	SWGC-1000
Capacity	432 l (1 door)	864 l (2 doors)
Temperature range & variation	10°C - +60°C, ±1°C at 20°C	
Temperature fluctuation	±0.5°C at 10°C, ±0.5°C at 25°C (0% light intensity) / ±1°C at 10°C, ±1°C at 25°C (100% light intensity)	
Humidity range, fluctuation & variation	30% - 95% RH, ±1%, ±3% at 60°C	
Humidifier	evaporation by fan with heater	
Illumination lamp & range	14 x FPL 55 W, 0 to 12,000 Lux	28 x FPL 55 W, 0 to 15,000 Lux
Illumination bank	3x light banks: left, right, front	
Temperature & humidity sensor	temperature: PT100, humidity: capacitive sensor	
Heat-up time (up to 37°C)	11 min (0% illumination) / 9 min (100% illumination)	
Cool-down time (down to 10°C)	13 min (0% illumination) / 15 min (100% illumination)	
Recovery time (door open 30sec)	3 min. to 10°C, 1 min. to 37°C (0% illumination); 5 min. to 10°C, 1 min. to 37°C (100% illumination)	
Heating power (temperature & humidity)	1.5 kW	3.0 kW
Compressor	370 W	750 W
Program function	temperature and humidity: 120 patterns, 1.200 segments; light bank: 8 steps	
Shelves	4 x PE-coated steel wire shelves (16 kg / shelf)	8 x PE-coated steel wire shelves (16 kg / shelf)
Internal dimensions (W x D x H)	650 x 700 x 1050 mm	1200 x 790 x 1050 mm
External dimensions (W x D x H)	850 x 1090 x 1965 mm	1200 x 1150 x 1965 mm
Packing size & gross weight	1400 x 1220 x 2210 mm, 435 kg	1600 x 1500 x 2200 mm, 585 kg
Power supply	1 Phase AC 120V, 60 Hz or AC 230V, 50/60 Hz or 3 Phase	
Power consumption	4,8 kW	6,5 kW
Order number 230V*	DH.SWGC00450	DH.SWGC01000
Order number 120V*	DH.SWGC50450	DH.SWGC51000
Order number 3 Phase	DH.SWGC60450	DH.SWGC61000

* 230V and 120V models not available in Europe

Universal platforms

• suitable for shaking incubators **WIS**

For device...	Measurements	Article	Order number
WIS-30 / WIS-30R	485 x 405 mm	SP630	DH.WIS504630
WIS-20 / WIS-20R	478 x 478 mm	SP600	DH.WIS504600
WIS-10 / WIS-10R / WIS-10RL	688 x 648 mm	SP610	DH.WIS504610
WIS-ML02 / WIS-ML04	645 x 645 mm	SP620	DH.WIS504620

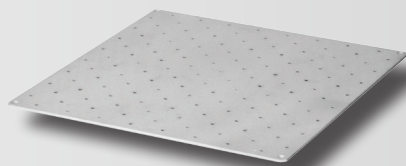

Universal spring racks

• suitable for shaking incubators **WIS**

For device...	Measurements	Article	Order number
WIS-30 / WIS-30R	498x408xh135 mm	SR530	DH.WIS504530
WIS-20 / WIS-20R	483x483xh135 mm	SR500	DH.WIS504500
WIS-10 / WIS-10R / WIS-10RL	693x653xh135 mm	SR510	DH.WIS504510
WIS-ML02 / WIS-ML04	653x653xh135 mm	SR520	DH.WIS504520

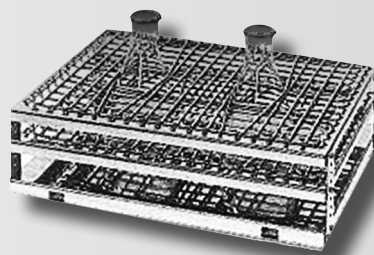

Flask holder ABS or STS

• suitable for shaking incubators **WIS**

Type	For flasks...	Article	Order number
ABS flask holder	50-100 ml	FH100	DH.WIS504030
ABS flask holder	200-300 ml	FH250	DH.WIS504035
ABS flask holder	500-1000 ml	FH500	DH.WIS504040
STS wire spring flask holder	100 ml	FHS100	DH.WIS600100
STS wire spring flask holder	250 ml	FHS250	DH.WIS600250
STS wire spring flask holder	500 ml	FHS500	DH.WIS600500
STS wire spring flask holder	1000 ml	FHS1000	DH.WIS601000



ABS

STS wire

Shaking incubators
WIS

Perforated shelves, stainless steel

• suitable for incubators / growth chambers **STH, STH-E**

For device...	Measurements	Article	Order number
STH-155, STH-E155	470 x 480 mm	THS1155	DH.WTH11155
STH-305, STH-E305	590 x 580 mm	THS1305	DH.WTH11305
STH-420, STH-E420	720 x 640 mm	THS1420	DH.WTH11420
STH-800, STH-E800	970 x 980 mm	THS1800	DH.WTH11800

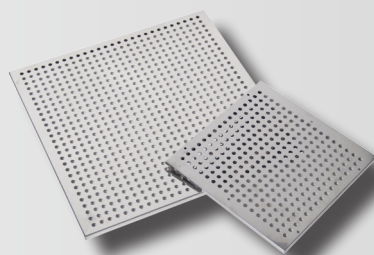

Temperature recorder and chart paper

• suitable for incubators / growth chambers **STH, STH-E**

For device...	Recorder	Article	Order number
STH, STH-E	temperature, humidity (6 channels, 2 pens, paper)	WTH5100	DH.WTH05100
WTH5100	paper for 33 days	WTH5105	DH.WTH05105



PE-coated wire shelves, steel wire

• suitable for incubators / growth chambers **SWG**

For device...	Measurements	Article	Order number
SWG-450	640 x 620 mm	GCS450	DH.WGC10450
SWG-1000	580 x 620 mm	GCS1000	DH.WGC11000

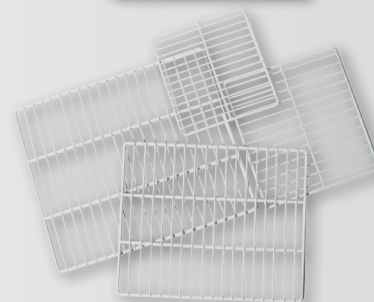

Incubators / growth chambers
STH | STH-E | SWGC

Oven | gravity-air

Jog-Dial controller, gravity-air convection, up to 230°C, 32 / 50 / 105 / 155 l



Gravity-air
3-sided heater



Wise remote



Jog-Dial controller

WON 230°C, 32/50/105/155 l

Ideal for:

- drying, baking, conditioning, curing, pre-heating and aging

Features:

- optimized air flow by gravity-air mechanism
- 3-side heating ensures temperature uniformity and accuracy
- ambient +5°C to 230°C range, fluctuation of $\pm 0.5^\circ\text{C}$ at 100°C
- RS232C interface for monitoring and controlling (WireRemote)
- stainless steel chamber
- powder-coated steel body and glass wool insulation
- available with viewing window (WON-W models)
- new compact body design
- storage function for set values of temperature and timer
- backlight LCD display
- 2x stainless steel wire shelves included
- CE & UL/CUL certified and unique serial number for tracing

Safety mechanism:

- locking mode
- overheat and over-current protection
- sensor error detection

Controller:

- **Jog-Dial controller (PID)** with 2-way knob (turn and push), digital LCD with backlight, and two durable setting buttons

IQ | OQ
available
page 12 for details



WON-W105 with viewing window
and 2x wire shelves (included)

Model	WON-32	WON-50	WON-105 / WON-W105*	WON-155 / WON-W155*
Capacity	32 l	50 l	105 l	155 l
Temperature range, variation & sensor	room temperature +5°C - 230°C, variation: $\pm 1.2^\circ\text{C}$ at 100°C, $\pm 2.2^\circ\text{C}$ at 150°C, sensor: PT 100			
Temperature fluctuation	$\pm 0.5^\circ\text{C}$ at 100°C, $\pm 0.6^\circ\text{C}$ at 150°C			$\pm 0.5^\circ\text{C}$ at 100°C, $\pm 0.8^\circ\text{C}$ at 150°C
Heating power	500 W	650 W	1.4 kW	1.6 kW
Heat-up time	30 min to 100°C, 43 min to 150°C	30 min to 100°C, 45 min to 150°C		35 min to 100°C, 50 min to 150°C
Recovery time (door open 30 sec)	8 min to 100°C, 10 min to 150°C		12 min to 100°C, 10 min to 150°C	
Timer & alarm	99hr 59 min (delay & continuous run)			
Control resolution	$\pm 0.1^\circ\text{C}$			
Shelves	2 x stainless steel wire shelves included, load per shelf 16 kg			
Ventilation	1x hole \varnothing 35 mm ventilation hole with stainless steel cap		2x hole \varnothing 35 mm ventilation hole with stainless steel cap	
Internal dimensions (W x D x H)	310x290x360 mm	370x350x420 mm	485x409x535 mm	550x474x600 mm
External dimensions (W x D x H) & net weight	458x557x664 mm, 36 kg	518x647x724 mm, 44 kg	653x712x882 mm, 79 kg	718x777x947 mm, 78 kg
Packing size & gross weight	562x664x747 mm, 43 kg	622x754x807 mm, 59 kg	743x819x1068 mm, 79 kg	808x884x1133 mm, 92 kg
Power supply	1 Phase AC 120V, 60 Hz or AC 230V, 50/60 Hz			
Power consumption	502 W	674 W	1390 W	1566 W
Energy consumption at 100°C/ at 150°C	90 Wh / 181 Wh	117 Wh / 230 Wh	187 Wh / 337 Wh	204 Wh / 398 Wh
Order number 230V	DH.WON05032	DH.WON05050	DH.WON05105	DH.WON05155
Order number 120V	DH.WON06032	DH.WON06050	DH.WON06105	DH.WON06155
Order number built-in viewing window 230V	-	-	DH.WON07105	DH.WON07155
Order number built-in viewing window 120V	-	-	DH.WON08105	DH.WON08155

* built-in viewing window model

Accessories: Suitable shelves can be found on page 84

Oven | gravity-air

SMART-Lab™ controller, gravity-air convection, up to 230°C, 32 / 50 / 105 / 155 l



Gravity-air
3-sided heater



SMART-Lab™ controller



WiRe™ app service

SWON 230°C, 32/50/105/155 l

Ideal for:

- drying, baking, conditioning, curing, pre-heating and aging

Features:

- optimized air flow by gravity-air mechanism
- 3-side heating ensures temperature uniformity and accuracy
- ambient +5°C to 230°C range, fluctuation of ±0.5°C at 100°C
- stainless steel chamber
- powder-coated steel body and glass wool insulation
- available with viewing window (SWON-W models)
- new compact body design
- storage function for set values of temperature and timer
- 2x stainless steel wire shelves included
- CE & UL/CUL certified and unique serial number for tracing

Safety mechanism:

- push alarm service to your smartphone
- locking mode
- overheat and over-current protection
- sensor error detection

Controller:

- **Smart-Lab™ controller** with 4" full touch screen TFT LCD:
 - ◆ WiRe™ app service, remote control system
 - ◆ variable program settings
 - ◆ self-diagnostic function
 - ◆ automatic data recording
 - ◆ data transfer to PC by USB memory
 - ◆ Internet connectivity with WiFi

IQ | OQ
available
page 12 for details



SWON-W105 with viewing window
and 2x wire shelves (included)

Model	SWON-32	SWON-50	SWON-105 / SWON-W105*	SWON-155 / SWON-W155*
Capacity	32 l	50 l	105 l	155 l
Temperature range, variation & sensor	room temperature +5°C - 230°C, variation: ±1.2°C at 100°C, ±2.2°C at 150°C, sensor: PT 100			
Temperature fluctuation	±0.5°C at 100°C, ±0.6°C at 150°C			±0.5°C at 100°C, ±0.8°C at 150°C
Heating power	500 W	650 W	1.4 kW	1.6 kW
Heat-up time	30 min to 100°C, 43 min to 150°C	30 min to 100°C, 45 min to 150°C		35 min to 100°C, 50 min to 150°C
Recovery time (door open 30 sec)	8 min to 100°C, 10 min to 150°C		12 min to 100°C, 10 min to 150°C	
Timer & alarm	99hr 59 min (delay & continuous run)			
Control resolution	±0.1°C			
Shelves	2 x stainless steel wire shelves included, load per shelf 16 kg			
Ventilation	1x hole Ø 35 mm ventilation hole with stainless steel cap		2x hole Ø 35 mm ventilation hole with stainless steel cap	
Internal dimensions (W x D x H)	310x290x360 mm	370x350x420 mm	485x409x535 mm	550x474x600 mm
External dimensions (W x D x H), net weight	458x557x664 mm, 36kg	518x647x724 mm, 44kg	653x712x882 mm, 69kg	718x777x947 mm, 78kg
Packing size & gross weight	562x664x747 mm, 43kg	622x754x807 mm, 59kg	743x819x1068 mm, 79kg	808x884x1133 mm, 92kg
Power supply	1 Phase AC 120V, 60 Hz or AC 230V, 50/60 Hz			
Power consumption	502 W	674 W	1390 W	1566 W
Energy consumption at 100°C/ at 150°C	90 Wh / 181 Wh	117 Wh / 230 Wh	187 Wh / 337 Wh	204 Wh / 398 Wh
Order number 230V	DH.SWON05032	DH.SWON05050	DH.SWON05105	DH.SWON05155
Order number 120V	DH.SWON06032	DH.SWON06050	DH.SWON06105	DH.SWON06155
Order number built-in viewing window 230V	-	-	DH.SWON07105	DH.SWON07155
Order number built-in viewing window 120V	-	-	DH.SWON08105	DH.SWON08155

* built-in viewing window model

Accessories: Suitable shelves can be found on page 84

Oven | forced-air

Jog-Dial controller, forced-air convection, up to 250°C, 50 / 105 / 155 l



WOF 250°C, 50/105/155 l

Ideal for:

- drying, baking, conditioning, curing, pre-heating and aging

Features:

- optimized air flow by forced-air mechanism
- 3-side heating ensures temperature uniformity and accuracy
- ambient +5°C to 250°C range, fluctuation of $\pm 0.3^\circ\text{C}$ at 100°C
- RS232C interface for monitoring and controlling (WireRemote)
- stainless steel chamber
- powder-coated steel body and glass wool insulation
- available with viewing window (WOF-W models)
- new compact body design
- storage function for set values of temperature and timer
- backlight LCD display
- 2x stainless steel wire shelves included
- CE & UL/CUL certified and unique serial number for tracing

Safety mechanism:

- locking mode
- overheat and over-current protection
- sensor error detection

Controller:

- **Jog-Dial controller (PID)** with 2-way knob (turn and push), digital LCD with backlight, and two durable setting buttons

IQ | OQ
available
page 12 for details



WOF-W105 with viewing window and 2x wire shelves (included)

Model	WOF-50	WOF-105 / WOF-W105*	WOF-155 / WOF-W155*
Capacity	50 l	105 l	155 l
Temperature range, fluctuation & sensor	range: room temperature +5°C - 250°C, fluctuation: $\pm 0.3^\circ\text{C}$ at 100°C, $\pm 0.5^\circ\text{C}$ at 150°C, PT 100		
Temperature variation	$\pm 1^\circ\text{C}$ at 100°C, 1.8°C at 150°C		$\pm 1^\circ\text{C}$ at 100°C, $\pm 2^\circ\text{C}$ at 150°C
Heating power	650 W	1.4 kW	1.6 kW
Heat-up time	25 min to 100°C, 45 min to 150°C		25 min to 100°C, 40 min to 150°C
Recovery time (door open 30 sec)	8 min to 100°C, 8 min to 150°C		6 min to 100°C, 6 min to 150°C
Timer & alarm	99hr 59 min (delay & continuous run)		
Control resolution	$\pm 0.1^\circ\text{C}$		
Shelves	2 x stainless steel wire shelves included, load per shelf 16 kg		
Ventilation	1 x hole \varnothing 35 mm ventilation hole with stainless steel cap	2 x hole \varnothing 35 mm ventilation hole with stainless steel cap	
Internal dimensions (W x D x H)	370 x 345 x 420 mm	485 x 415 x 535 mm	550 x 480 x 600 mm
External dimensions (W x D x H), net weight	518 x 647 x 724 mm, 44 kg	653 x 712 x 882 mm, 69 kg	718 x 777 x 947 mm, 78 kg
Packing size & gross weight	622 x 754 x 807 mm, 59 kg	743 x 819 x 1068 mm, 79 kg	808 x 884 x 1133 mm, 92 kg
Power supply	1 Phase AC 120V, 60 Hz or AC 230V, 50/60 Hz		
Power consumption	674 W	1390 W	1566 W
Energy consumption at 100°C/ at 150°C	117 Wh / 230 Wh	187 Wh / 337 Wh	204 Wh / 398 Wh
Order number 230V	DH.WOF05050	DH.WOF05105	DH.WOF05155
Order number 120V	DH.WOF06050	DH.WOF06105	DH.WOF06155
Order number built-in viewing window 230V	-	DH.WOF07105	DH.WOF07155
Order number built-in viewing window 120V	-	DH.WOF08105	DH.WOF08155

* built-in viewing window model

Accessories: Suitable shelves can be found on page 84

Oven | forced-air

SMART-Lab™ controller, forced-air convection, up to 250°C, 50 / 105 / 155 l

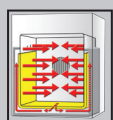

Forced-air
3-sided heater



SMART-Lab™ controller



WiRe™ app service

SWOF 250°C, 50/105/155 l

Ideal for:

- drying, baking, conditioning, curing, pre-heating and aging

Features:

- optimized air flow by forced-air mechanism
- 3-side heating ensures temperature uniformity and accuracy
- ambient +5°C to 250°C range, fluctuation of $\pm 0.3^\circ\text{C}$ at 100°C
- stainless steel chamber
- powder-coated steel body and glass wool insulation
- available with viewing window (SWOF-W models)
- new compact body design
- storage function for the set values of temperature and timer
- 2x stainless steel wire shelves included
- CE & UL/CUL certified and unique serial number for tracing

Safety mechanism:

- push alarm service to your smartphone
- locking mode
- overheat and over-current protection
- sensor error detection

Controller:

- **Smart-Lab™ controller** with 4" full touch screen TFT LCD:
 - ◆ WiRe™ app service, remote control system
 - ◆ variable program settings
 - ◆ self-diagnostic function
 - ◆ automatic data recording
 - ◆ data transfer to PC by USB memory
 - ◆ Internet connectivity with WiFi

IQ | OQ
available
page 12 for details



SWOF-W105 with viewing window
and 2x wire shelves (included)

Model	SWOF-50	SWOF-105 / SWOF-W105*	SWOF-155 / SWOF-W155*
Capacity	50 l	105 l	155 l
Temperature range, fluctuation & sensor	range: room temperature +5°C - 250°C, fluctuation: $\pm 0.3^\circ\text{C}$ at 100°C, $\pm 0.5^\circ\text{C}$ at 150°C, PT 100		
Temperature variation	$\pm 1^\circ\text{C}$ at 100°C, 1.8°C at 150°C		$\pm 1^\circ\text{C}$ at 100°C, $\pm 2^\circ\text{C}$ at 150°C
Heating power	650 W	1.4 kW	1.6 kW
Heat-up time	25 min to 100°C, 45 min to 150°C	25 min to 100°C, 40 min to 150°C	
Recovery time (door open 30 sec)	8 min to 100°C, 8 min to 150°C	6 min to 100°C, 6 min to 150°C	
Timer & alarm	99hr 59 min (delay & continuous run)		
Control resolution	$\pm 0.1^\circ\text{C}$		
Shelves	2 x stainless steel wire shelves included, load per shelf 16 kg		
Ventilation	1 x hole \varnothing 35 mm ventilation hole with stainless steel cap	2 x hole \varnothing 35 mm ventilation hole with stainless steel cap	
Internal dimensions (W x D x H)	370 x 345 x 420 mm	485 x 415 x 535 mm	550 x 480 x 600 mm
External dimensions (W x D x H), net weight	518 x 647 x 724 mm, 44 kg	653 x 712 x 882 mm, 69 kg	718 x 777 x 947 mm, 78 kg
Packing size & gross weight	622 x 754 x 807 mm, 59 kg	743 x 819 x 1068 mm, 79 kg	808 x 884 x 1133 mm, 92 kg
Power supply	1 Phase AC 120V, 60 Hz or AC 230V, 50/60 Hz		
Power consumption	674 W	1390 W	1566 W
Energy consumption at 100°C/ at 150°C	117 Wh / 230 Wh	187 Wh / 337 Wh	204 Wh / 398 Wh
Order number 230V	DH.SWOF05050	DH.SWOF05105	DH.SWOF05155
Order number 120V	DH.SWOF06050	DH.SWOF06105	DH.SWOF06155
Order number built-in viewing window 230V	-	DH.SWOF07105	DH.SWOF07155
Order number built-in viewing window 120V	-	DH.SWOF08105	DH.SWOF08155

* built-in viewing window model

Accessories: Suitable shelves can be found on page 84

Oven | vacuum oven

Jog-Dial controller, 10 - 750 mm Hg (0.63 mbar), up to 200°C, 18.6 / 30 / 70 l



Optimized gas exchange



Wise remote



Jog-Dial controller

WOV 200°C, 18.6/30/70 l, 750mmHg

Ideal for:

- drying, baking, conditioning, curing, out-glassing solids and liquids, vacuum embedding, moisture testing, plating and aging test

Features:

- very easy and convenient for vacuuming and venting, easy to read vacuum gauge
- high quality door sealing: high temperature grade silicone molded gasket
- superior uniformity and stability
- safety window: tempered safety glass 12T & polycarbonate 5T
- RS232C interface for monitoring and controlling (WireRemote)
- stainless steel interior, powder-coated steel body and glass wool insulation
- 2x aluminium shelves included
- storage function for set values of alarm and timer
- backlight LCD display
- CE & UL/CUL certified and unique serial number for tracing

Safety mechanism:

- locking mode
- overheat and over-current protection
- sensor error detection and leakage breaker

Controller:

- **Jog-Dial controller (PID)** with 2-way knob (turn and push), digital LCD with backlight, and two durable setting buttons

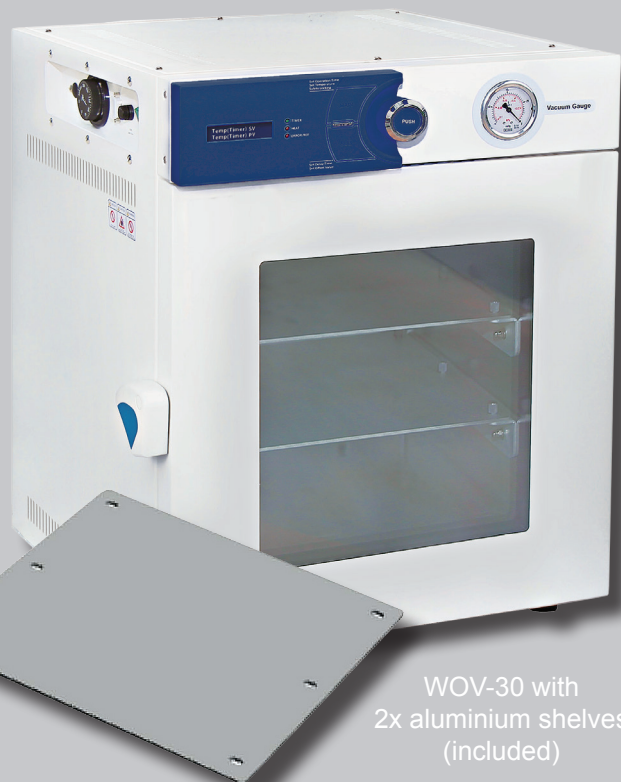

WOV-30 with 2x aluminium shelves (included)

Model	WOV-20	WOV-30	WOV-70
Capacity	18.6 l	30 l	70 l
Vacuum range, level & rate	10 - 750 mmHg, 0.63 mbar, 0.39 mbar/h		
Temperature range, fluctuation & sensor	room temperature +5°C - 200°C, fluctuation: ±0.5°C at 100°C & 150°C, PT 100 sensor		
Temperature variation	±2.0°C at 100°C, ±3.0°C at 150°C		±2.5°C at 100°C, ±3.5 at 150°C
Heating power	2 x 170 W, 2 x 130 W		2 x 350 W, 2 x 450 W
Heat-up time	60 min. to 100°C 90 min. to 150°C	70 min. to 100°C 100 min. to 150°C	80 min. to 100°C 100 min. to 150°C
Timer & alarm	99hr 59 min (delay & continuous run) and timer end		
Resolution	control: ±1.0°C, display: ±1.0°C		
Height between shelves	87 mm	98 mm	133 mm
Vacuum inlet valve size	outer Ø10 mm		
Internal dimensions (W x D x H)	265 x 290 x 265 mm	300 x 330 x 300 mm	400 x 435 x 400 mm
External dimensions (W x D x H), net weight	480 x 475 x 552 mm, 48 kg	515 x 515 x 587 mm, 55 kg	618 x 620 x 687 mm, 85 kg
Packing size & gross weight	585 x 580 x 795 mm, 59 kg	620 x 620 x 830 mm, 67 kg	725 x 720 x 930 mm, 100 kg
Power supply	1 Phase AC 120V, 60 Hz or AC 230V, 50/60 Hz		
Power consumption	600 W	600 W	1,6 kW
Order number 230V	DH.WOV03020	DH.WOV03030	DH.WOV03070
Order number 120V	DH.WOV04020	DH.WOV04030	DH.WOV04070

Recommended vacuum pump for 18.6l- and 30l-oven: Rocker 810, see page 190

Recommended vacuum pump for 70l-oven: Rocker 800/Rocker 811, see page 190/191

Accessories: Suitable shelves can be found on page 84

Oven | vacuum oven

SMART-Lab™ controller, 10 - 750 mm Hg (0.63 mbar), up to 200°C, 18.6 / 30 / 70 l



Optimized gas exchange



SMART-Lab™ controller



WiRe™ app service

SWOV 200°C, 18.6/30/70 l, 750mmHg

Ideal for:

- drying, baking, conditioning, curing, out-glassing solids and liquids, vacuum embedding, moisture testing, plating and aging test

Features:

- very easy and convenient for vacuuming and venting, easy to read vacuum gauge
- high quality door sealing: high temperature grade silicone molded gasket
- superior uniformity and stability
- safety window: tempered safety glass 12T & polycarbonate 5T
- compact new body design
- 2x aluminium shelves included
- stainless steel interior, powder-coated steel body and glass wool insulation
- CE & UL/CUL certified and unique serial number for tracing

Safety mechanism:

- push alarm service to your smartphone
- overheat and over-current protection
- sensor error detection and leakage breaker

Controller:

- **Smart-Lab™ controller** with 4" full touch screen TFT LCD:
 - ◆ WiRe™ app service, remote control system
 - ◆ variable program settings
 - ◆ self-diagnostic function
 - ◆ automatic data recording
 - ◆ data transfer to PC by USB memory
 - ◆ Internet connectivity with WiFi

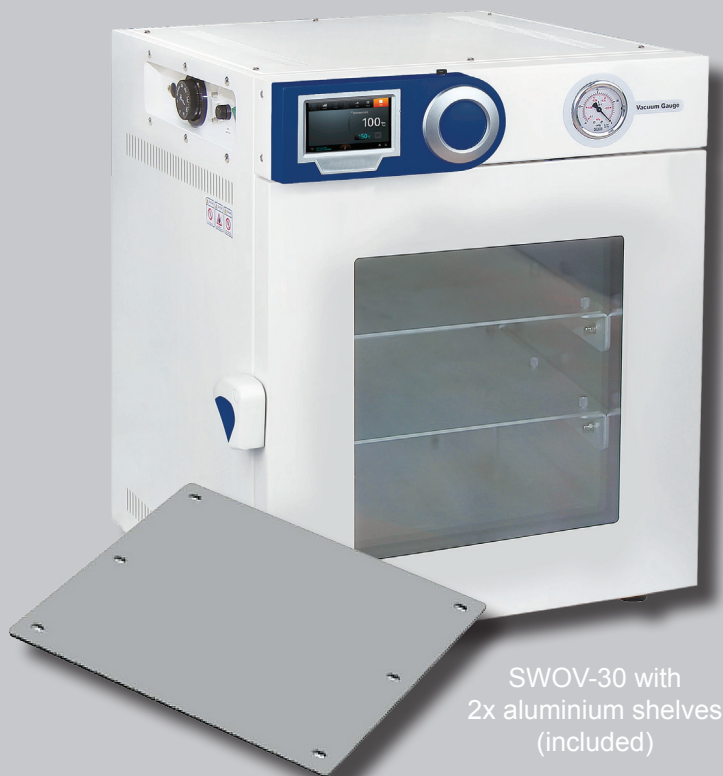

SWOV-30 with 2x aluminium shelves (included)

Model	SWOV-20	SWOV-30	SWOV-70
Capacity	18.6 l	30 l	70 l
Vacuum range, level & rate	10 - 750 mmHg, 0.63 mbar, 0.39 mbar/h		
Temperature range, fluctuation & sensor	room temperature +5°C - 200°C, fluctuation: ±0.5°C at 100°C & 150°C, PT 100 sensor		
Temperature variation	±2.0°C at 100°C, ±3.0°C at 150°C		±2.5°C at 100°C, ±3.5 at 150°C
Heating power	2 x 170 W, 2 x 130 W		2 x 350 W, 2 x 450 W
Heat-up time	60 min. to 100°C 90 min. to 150°C	70 min. to 100°C 100 min. to 150°C	80 min. to 100°C 100 min. to 150°C
Timer & alarm	99hr 59 min (delay & continuous run), error status and timer end		
Resolution	control: ±1.0°C, display: ±1.0°C		
Height between shelves	87 mm	98 mm	133 mm
Vacuum inlet valve size	outer Ø10 mm		
Internal dimensions (W x D x H)	265 x 290 x 265 mm	300 x 330 x 300 mm	400 x 435 x 400 mm
External dimensions (W x D x H), net weight	480 x 475 x 552 mm, 48 kg	515 x 515 x 587 mm, 55 kg	618 x 620 x 687 mm, 85 kg
Packing size & gross weight	585 x 580 x 795 mm, 59 kg	620 x 620 x 830 mm, 67 kg	725 x 720 x 930 mm, 100 kg
Power supply	1 Phase AC 120V, 60 Hz or AC 230V, 50/60 Hz		
Power consumption	600 W	600 W	1,6 kW
Order number 230V	DH.SWOV03020	DH.SWOV03030	DH.SWOV03070
Order number 120V	DH.SWOV04020	DH.SWOV04030	DH.SWOV04070

Recommended vacuum pump for 18.6l- and 30l-oven: Rocker 810, see page 190

Recommended vacuum pump for 70l-oven: Rocker 800/Rocker 811, see page 190/191

Accessories: Suitable shelves can be found on page 84

Oven | muffle furnace

up to 1,000°C, Jog-Dial controller, 3 / 4.5 / 12 / 14 / 27 / 63 l, programmable

FP 1,000°C, programmable

Ideal for:

- ash-determinations, enameling, fusions, precipitate drying

Features:

- user's self-compensation function for temperature ($\pm 50.0^\circ\text{C}$)
- resolution: 1°C , 1 min
- ceramic fiber plate included
- powder-coated steel body, ceramic fiber insulation, ceramic fiber exposed heating wire interior with 4-sided heating
- backlight LCD display
- CE certified and unique serial number for tracing



Jog-Dial controller



4-sided heating

up to 1,000 °C
Jog-Dial
programmable

Safety mechanism:

- safety switch for door opening
- overheat and over-current protection
- sensor error detection

Controller:

- **Jog-Dial controller (PID)** with 2-way knob (turn and push), digital LCD with backlight, and two durable setting buttons
- programmable: 4 patterns with 10 segments



FP-14 with ceramic fiber plate (included)

Model	FP-03	FP-05	FP-12	FP-14	FP-27	FP-63
Capacity	3 l	4.5 l	12 l	14 l	27 l	63 l
Temperature range	300°C - 1000°C					
Heater	Kanthal A1, expose wire heating elements, 4-side heating					
Thermocouple	K-type thermocouple					
Heating power	1.4 kW	1.8 kW	3.6 kW	4.0 kW	4.6 kW	9 kW
Required time to reach 800°C	16 min			20 min		23 min
Timer & alarm	99hr 59 min (delay & continuous run), error status and timer end					
Internal dimensions (W x D x H mm)	130x250x90	150x300x100	200x300x200	250x350x160	300x300x300	400x400x400
External dimensions (W x D x H mm)	410x480x530	440x530x550	500x550x660	550x580x620	600x590x760	1000x730x920
Packing size (W x D x H mm) & gross weight	630x540x770 47 kg	680x570x780 54 kg	700x630x890 59 kg	740x680x850 73 kg	740x730x990 83 kg	1160x900x1100 225 kg
Power supply	1 Phase AC 120V, 60 Hz or 1 Phase AC 230V, 50/60 Hz			1 Phase AC 120V, 60 Hz or 1 Phase AC 230V, 50/60 Hz or 3 Phase AC 400V, 50/60 Hz		
Order number 230V	DH.WF21.P03	DH.WF21.P05	DH.WF21.P12*	DH.WF21.P14*	DH.WF21.P27*	DH.WF21.P63*
Order number 120V	DH.WF20.P03	DH.WF20.P05	DH.WF20.P12*	DH.WF20.P14*	DH.WF20.P27*	DH.WF20.P63*
Order number 3 Phase	-	-	DH.WF23.P12	DH.WF23.P14	DH.WF23.P27	DH.WF23.P63

* models not available in Europe

Accessories: Suitable spare fiber plates can be found on page 84
Suitable crucibles can be found on page 242

Oven | muffle furnace

up to 1,200°C, Jog-Dial controller, 3 / 4.5 / 12 / 14 / 27 / 63 l, programmable

FHP 1,200°C, programmable

Ideal for:

- ash-determinations, enameling, fusions, precipitate drying

Features:

- user's self-compensation function for temperature ($\pm 50.0^\circ\text{C}$)
- resolution: 1°C , 1 min
- ceramic fiber plate included
- powder-coated steel body, ceramic fiber insulation, ceramic fiber exposed heating wire interior with 4-sided heating
- backlight LCD display
- CE certified and unique serial number for tracing

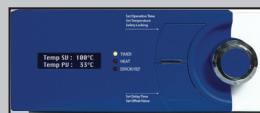

Jog-Dial controller



4-sided heating

up to 1,200 °C
Jog-Dial
programmable

Safety mechanism:

- safety switch for door opening
- overheat and over-current protection
- sensor error detection

Controller:

- **Jog-Dial controller (PID)** with 2-way knob (turn and push), digital LCD with backlight, and two durable setting buttons
- programmable: 4 patterns with 10 segments



FHP-14 with ceramic fiber plate (included)

Model	FHP-03	FHP-05	FHP-12	FHP-14	FHP-27	FHP-63
Capacity	3 l	4.5 l	12 l	14 l	27 l	63 l
Temperature range	300°C - 1200°C					
Heater	Kanthal A1, expose wire heating elements, 4-side heating					
Thermocouple	K-type thermocouple					
Heating power	1.4 kW	1.8 kW	3.6 kW	4.0 kW	4.6 kW	9 kW
Required time to reach 800°C	16 min		20 min		23 min	
Timer & alarm	99hr 59 min (delay & continuous run), error status and timer end					
Internal dimensions (W x D x H mm)	130x250x90	150x300x100	200x300x200	250x350x160	300x300x300	400x400x400
External dimensions (W x D x H mm)	410x480x530	440x530x550	500x550x660	550x580x620	600x590x760	1000x730x920
Packing size (W x D x H mm) & gross weight	630x540x770 47 kg	680x570x780 54 kg	700x630x890 59 kg	740x680x850 73 kg	740x730x990 83 kg	1160x900x1100 225 kg
Power supply	1 Phase AC 120V, 60 Hz or 1 Phase AC 230V, 50/60 Hz		1 Phase AC 120V, 60 Hz or 1 Phase AC 230V, 50/60 Hz or 3 Phase AC 400V, 50/60 Hz			
Order number 230V	DH.WFH22.P03	DH.WFH22.P05	DH.WFH22.P12*	DH.WFH22.P14*	DH.WFH22.P27*	DH.WFH22.P63*
Order number 120V	DH.WFH20.P03	DH.WFH20.P05	DH.WFH20.P12*	DH.WFH20.P14*	DH.WFH20.P27*	DH.WFH20.P63*
Order number 3 Phase	-	-	DH.WFH23.P12	DH.WFH23.P14	DH.WFH23.P27	DH.WFH23.P63

* models not available in Europe

Accessories: Suitable spare fiber plates can be found on page 84
Suitable crucibles can be found on page 242

Oven | muffle furnace

NEW

500°C - 1,450°C, PID controller, 1.9 / 4.5 / 11 / 22 l, programmable



2-sided heating

up to 1,450°C
PID controller
programmable

FSC 1,450°C, programmable

Ideal for:

- ash-determinations, enameling, fusions, precipitate drying

Features:

- ceramic fiber exposed heating wire
- 2-sided heating
- without ceramic fiber plate (please order separately)
- high quality insulation: ceramic fiber board
- LCD display
- CE certified and unique serial number for tracing

Safety mechanism:

- safety switch for door opening (only FSC-2)
- overheat and over-current protection
- sensor error detection

Controller:

- **digital PID controller**, UP35A, SCR-power controller with push button
- programmable: 2 patterns with 10 segments



FSC-2



Model	FSC-2	FSC-5	FSC-11	FSC-22
Temperature range	500°C - 1450°C			
Capacity	1.9 l	4.5 l	11 l	22 l
Heater	made from Silicon carbide (SiC), 2-sided heating			
Thermocouple	R-thermocouple			
Heating power	2 kW	3.3 kW	7.7 kW	9.6 kW
Required time to reach 800°C	30 min			
Timer & alarm	99 hr 59 min or continuous run			
Program function	2 patterns with 10 segments			
Safety mechanism	overheat and over-current protection sensor error detection safety switch for door opening	overheat and over-current protection, sensor error detection		
Material	ceramic fiber board with SiC-heater internal, powder-coated steel (external), ceramic fiber insulation			
Internal dimensions (W x D x H mm)	120 x 130 x 120	150 x 200 x 150	200 x 270 x 200	250 x 350 x 250
External dimensions (W x D x H mm)	440 x 482 x 700	820 x 555 x 655	870 x 625 x 715	920 x 705 x 785
Packing size (W x D x H mm) & gross weight	680 x 540 x 940, 57 kg	1350 x 600 x 980, 102 kg	1400 x 770 x 950, 102 kg	1450 x 900 x 1100, 132 kg
Power supply	Phase AC 120V, 60 Hz or AC 230V, 50/60 Hz, without cord and plug			
Order number 230V	DH.FSC02002	DH.FSC02005	DH.FSC02011*	DH.FSC02022*
Order number 120V	DH.FSC01002	DH.FSC01005	DH.FSC01011*	DH.FSC01022*

* models not available in Europe

Heat-resistant gloves

- long and flexible sleeve

Heat resistance	Order number
up to 700°C	NA.491041101

NEW

Oven | muffle furnace

600°C - 1,650°C, PID controller, 1.9 / 4.5 / 11 l, programmable



up to 1,650°C
PID controller
programmable

FSK 1,650°C, programmable

Ideal for:

- ash-determinations, enameling, fusions, precipitate drying

Features:

- ceramic fiber exposed heating wire
- 2-sided heating
- without ceramic fiber plate (please order separately)
- high quality insulation: ceramic fiber board
- LCD display
- CE certified and unique serial number for tracing

Safety mechanism:

- safety switch for door opening (only FSK-2)
- overheat and over-current protection
- sensor error detection

Controller:

- **digital PID controller**, UP35A, SCR-power controller with push button
- programmable: 2 patterns with 10 segments



Model	FSK-2	FSK-5	FSK-11
Capacity	1.9 l	4.5 l	11 l
Temperature range	600°C - 1,650°C		
Heater	made from molybdenum disilicide (MoSi ₂), 2-sided heating		
Thermocouple	B-thermocouple		
Heating power	1.3 kW	2.9 kW	6.6 kW
Required time to reach 800°C	40 min		
Timer & alarm	99 hr 59 min or continuous run		
Program function	2 patterns with 10 segments		
Safety mechanism	overheat and over-current protection sensor error detection safety switch for door opening	overheat and over-current protection, sensor error detection	
Material	ceramic fiber board with SIC-heater internal, powder-coated steel (external), ceramic fiber insulation		
Internal dimensions (W x D x H mm)	120 x 130 x 120 mm	150 x 200 x 150 mm	200 x 270 x 200 mm
External dimensions (W x D x H mm)	440 x 482 x 700 mm	900 x 600 x 695 mm	980 x 670 x 765 mm
Packing size (W x D x H mm) & gross weight	680 x 540 x 940 mm, 72 kg	1430 x 640 x 930 mm, 150 kg	1510 x 810 x 1000 mm, 186 kg
Power supply	Phase AC 120V, 60 Hz or AC 230V, 50/60 Hz, without cord and plug		
Order number 230V	DH.FSK02002	DH.FSK02005	DH.FSK02011*
Order number 120V	DH.FSK01002	DH.FSK01005	DH.FSK01011*

* models not available in Europe

Heat-resistant gloves

- long and flexible sleeve

Heat resistance	Order number
up to 700°C	NA.491041101

Oven

Accessories: shelves and plates

Wire shelves, stainless steel

• suitable for ovens **WON, WON-W, SWON, SWON-W**

For device...	Measurements	Article	Order number
WON-32 / SWON-32	280 x 280 mm	ONS032	DH.WON11032
WON-50 / SWON-50	340 x 310 mm	ONS050	DH.WON11050
WON-105 / WON-W105 SWON-105 / SWON-W105	455 x 375 mm	ONS105	DH.WON11105
WON-155 / WON-W155 SWON-155 / SWON-W155	520 x 440 mm	ONS155	DH.WON11155

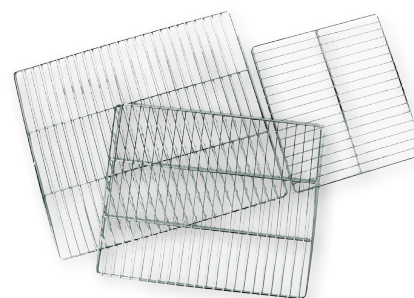

Wire shelves, stainless steel

• suitable for ovens **WOF, WOF-W, SWOF, SWOF-W**

For device...	Measurements	Article	Order number
WOF-50 / SWOF-50	340 x 310 mm	OFS050	DH.WOF11050
WOF-105 / WOF-W105 SWOF-105 / SWOF-W105	455 x 375 mm	OFS105	DH.WOF11105
WOF-155 / WOF-W155 SWOF-155 / SWOF-W155	520 x 440 mm	OFS155	DH.WOF11155

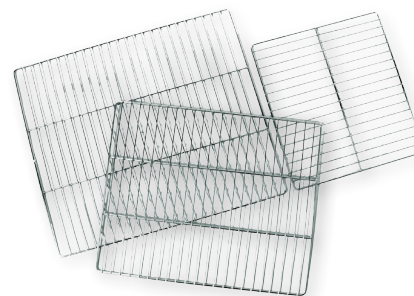

Ceramic fiber plates

• suitable for ovens / muffle furnaces **FSC**

NEW

For device...	Measurements	Order number
FSC-2	110 x 120 mm	DH.FSC2002
FSC-5	140 x 180 mm	DH.FSC2005
FSC-11	190 x 250 mm	DH.FSC2011
FSC-22	240 x 330 mm	DH.FSC2022

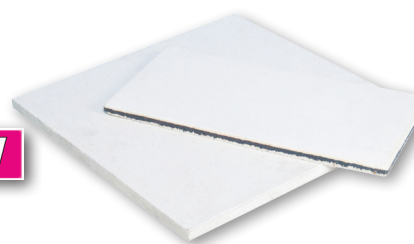

Ceramic fiber plates

• suitable for ovens / muffle furnaces **FSK**

NEW

For device...	Measurements	Order number
FSK-2	110 x 120 mm	DH.FSK2002
FSK-5	140 x 180 mm	DH.FSK2005
FSK-11	190 x 250 mm	DH.FSK2011

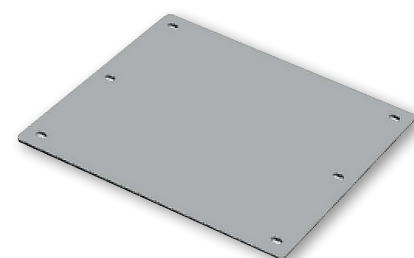

Shelves, aluminium

• suitable for vacuum ovens **WOV, SWOV**

For device...	Measurements	Article	Order number
WOV-20 / SWOV-20	260 x 245 x 3 mm	OVSN020	DH.WOV12020
WOV-30 / SWOV-30	290 x 285 x 3mm	OVSN030	DH.WOV12030
WOV-70 / SWOV-70	390 x 390 x3 mm	OVSN070	DH.WOV12070

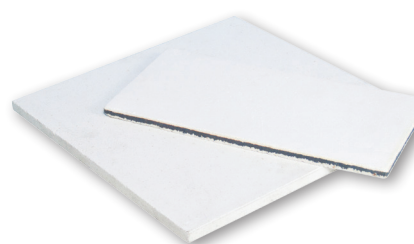

Ceramic fiber plates

• suitable for ovens / muffle furnaces **FP, FHP**

For device...	Article	Order number
FP-03 / FHP-03	FS1103	DH.WF211.03
FP-05 / FHP-05	FS1105	DH.WF211.05
FP-12 / FHP-12	FS1112	DH.WF211.12
FP-14 / FHP-14	FS1114	DH.WF211.14
FP-27 / FHP-27	FS1127	DH.WF211.27
FP-63 / FHP-63	FS1163	DH.WF211.63

COOLING & FREEZING



COOLING & FREEZING

Dry bath (Incubator).....	30
Bath (circulation).....	86
Cold trap.....	88
Refrigerator.....	90
Freezer.....	96
Freeze dryer.....	102

Bath | circulation water bath

circulation water bath, 8 / 12 / 22 / 30 l, -25°C - +150°C ±0.1°C, 25 l/min, flat lid included

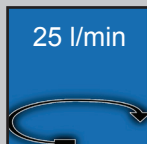
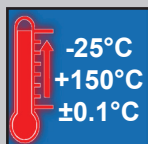

IQ | OQ
available
page 12 for details



Stainless steel flat lid (included)

Connection for external circulation Ø12.5mm

WCR -25°C - +150°C, digital

Ideal for:

- connection with evaporator

Features:

- stainless steel bath, polyurethane insulation of 40 mm thickness and body made of powder-coated steel
- innovated refrigeration system ensures temperature performance, includes intelligent control for preventing compressor overload, CFC-free (R-404A)
- innovated powerful circulation pump ensures temperature uniformity: internal and external circulation and 5 steps circulation speed
- stainless steel flat lid & valve ball included, dome lid optional
- RS232C interface: remote monitoring and controlling with PC
- proper liquid level tag in bath
- user's self-compensation function to control difference between real temperature and indicated temperature (±10.0°C)
- backlight LCD display
- CE certified and unique serial number for tracing

Safety mechanism:

- overheat and over-current protection
- sensor error detection and leakage breaker
- low liquid level warning and automatic stop function
- locking mode

Controller:

- digital fuzzy controller with **Jog-Dial-switch** (turn + push) & capacitive **touch button**

Model	WCR-8	WCR-12	WCR-22	WCR-30
Capacity	8 l	12 l	22 l	30 l
Temperature range & accuracy	-25°C - +150°C, ±0.1°C			
Temperature resolution	0.1°C-display, 0.1°C-control			
Temperature uniformity & probe	±0.2°C at -10°C, PT100			
Heating Power	1.0 kW	1.5 kW	2 kW	2.2 kW
External circulation nozzle	inner Ø10.5 mm, outer Ø12.5 mm, for inner circulating: connect directly the in-/outlet nozzles			
Pump	max. flow rate: 25l/min, max. pressure: 7.5 psi, max. lift: 4 m			
Refrigerator	250 W	250 W	370 W	560 W
Cooling capacity at +20°C	300 W	380 W	680 W	850 W
Cooling capacity at 0°C	200 W	250 W	500 W	620 W
Cooling capacity at -20°C	110 W	130 W	300 W	400 W
Timer & alarm	99hr 59 min (delay & continuous run), error status & timer end			
Effective space	175 x 153 x 150 mm	230 x 181 x 150 mm	290 x 220 x 200 mm	330 x 290 x 200 mm
Internal dimensions (W x D x H, mm)	175 x 320 x 150 mm	230 x 350 x 150 mm	290 x 390 x 200 mm	330 x 460 x 200 mm
External dimensions (W x D x H, mm)	330 x 474 x 752 mm	400 x 523 x 807 mm	483 x 563 x 850 mm	494 x 633 x 906 mm
Packing size & gross weight	560 x 420 x 922 mm, 45 kg	630 x 530 x 972 mm, 54 kg	670 x 615 x 1022 mm, 63 kg	740 x 625 x 1072 mm, 70 kg
Power supply	1 Phase AC 120V, 60 Hz or AC 230V, 50/60 Hz			
Order number 230V	DH.WCR00408	DH.WCR00412	DH.WCR00422	DH.WCR00430
Order number 120V	DH.WCR00508	DH.WCR00512	DH.WCR00522	DH.WCR00530

Bath | circulation water bath

circulation water bath, 8 / 12 / 22 / 30 l, -35°C - +150°C ±0.1°C, 25 l/min, flat lid included

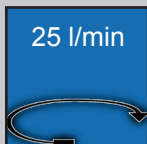
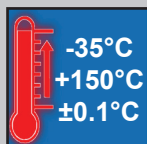

IQ | OQ
available
page 12 for details

WCL -35°C - +150°C, digital

Ideal for:

- connection with evaporator

Features:

- stainless steel bath, polyurethane insulation of 40 mm thickness and body made of powder-coated steel
- innovated refrigeration system ensures temperature performance, includes intelligent control for preventing compressor overload, CFC-free (R-404A)
- innovated powerful circulation pump ensures temperature uniformity: internal and external circulation and 5 steps circulation speed
- stainless steel flat lid & valve ball included, dome lid optional
- RS232C interface: remote monitoring and controlling with PC
- proper liquid level tag in bath
- user's self-compensation function to control difference between real temperature and indicated temperature (±10.0°C)
- backlight LCD display
- CE certified and unique serial number for tracing

Safety mechanism:

- overheat and over-current protection
- sensor error detection and leakage breaker
- low liquid level warning and automatic stop function
- locking mode

Controller:

- digital fuzzy controller with **Jog-Dial-switch** (turn + push) & capacitive **touch button**



Stainless steel flat lid (included)

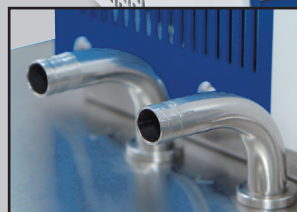

Connection for external circulation Ø12.5mm

Model	WCL-8	WCL-12	WCL-22	WCL-30
Capacity	8 l	12 l	22 l	30 l
Temperature range & accuracy	-35°C - +150°C, ±0.1°C			
Temperature resolution	0.1°C-display, 0.1°C-control			
Temperature uniformity & probe	±0.2°C at -20°C, PT100			
Heating Power	1.0 kW	1.5 kW	2 kW	2.2 kW
External circulation nozzle	inner Ø10,5 mm, outer Ø12,5 mm, for inner circulating: connect directly the in-/outlet nozzles			
Pump	max. flow rate: 25l/min, max. pressure: 7.5 psi, max. lift: 4 m			
Refrigerator	370 W	370 W	650 W	750 W
Cooling capacity at +20°C	500 W	530 W	860 W	1030 W
Cooling capacity at 0°C	340 W	370 W	620 W	760 W
Cooling capacity at -20°C	200 W	210 W	400 W	500 W
Timer & alarm	99hr 59 min (delay & continuous run), error status & timer end			
Effective space	175 x 153 x 150 mm	230 x 181 x 150 mm	290 x 220 x 200 mm	330 x 290 x 200 mm
Internal dimensions (W x D x H, mm)	175 x 320 x 150 mm	230 x 350 x 150 mm	290 x 390 x 200 mm	330 x 460 x 200 mm
External dimensions (W x D x H, mm)	400 x 523 x 807 mm	400 x 523 x 807 mm	483 x 563 x 850 mm	494 x 633 x 906 mm
Packing size & gross weight	630 x 530 x 972 mm, 50 kg	630 x 530 x 972 mm, 55 kg	670 x 615 x 1022 mm, 65 kg	740 x 625 x 1072 mm, 78 kg
Power supply	1 Phase AC 120V, 60 Hz or AC 230V, 50/60 Hz			
Order number 230V	DH.WCL00408	DH.WCL00412	DH.WCL00422	DH.WCL00430
Order number 120V	DH.WCL00508	DH.WCL00512	DH.WCL00522	DH.WCL00530

Cold trap

cold trap bath, -40 / -80°C, 2 glass cold traps included

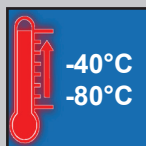

IQ | OQ
available
page 12 for details



WCT-40 with 2x glass cold trap (included)

WCT cold trap bath, -40/-80°C

Ideal for:

- collecting evaporation vapor or hazardous vapor from vacuum line

Features:

- stainless steel bath
- powder-coated steel, double painted & baked, 20 mm polyurethane-insulation
- digital timer function (99hr 59min): delay time and operation time can be controlled
- user's self-compensation function to control difference between real temperature and indicated temperature
- drain valve mounted
- backlight LCD display
- CE certified and unique serial number for tracing

Safety mechanism:

- locking mode
- over-current protection
- sensor error detection and leakage breaker

Controller:

- digital PID controller with **Jog-Shuttle-switch** (turn + push)

Model	WCT-40	WCT-80
Capacity	10 l	
Temperature range	-20°C up to -40°C	-65°C up to -80°C
Cold trap type	2 x glass trap	
Refrigerator	370 W	750 W
Refrigerant	R-404A	HFC
Internal dimensions (W x D x H, mm)	220 x 220 x 210 mm	
External dimensions (W x D x H, mm)	377 x 453 x 705 mm	
Packing size & gross weight	560 x 550 x 1010 mm, 67 kg	680 x 640 x 1130 mm, 90 kg
Power supply	1 Phase AC 120V, 60 Hz or AC 230V, 50/60 Hz	
Order number 230V	DH.WCT00140	DH.WCT00180
Order number 120V	DH.WCT00240	DH.WCT00280

Note: It's recommended to use ethanol as refrigerant as other refrigerants can damage components of the device

Accessories:



Spare glass cold trap for WCT

Measurements	Article	Order number
Ø106 x h249 mm, pressure resistance 1.5bar at 250°C, borosilicate glass 3.3	CTG1000	DH.WCT11000

... more from
witeg

NEW

Bottle-top dispenser

LABmax premium

Premium Design
Premium Performance
Premium Quality

The universal dispenser **LABmax premium** has a sophisticated system which allows air purging and draining without any loss of reagent! Due to the direct displacement system, **LABmax premium** is ideal for crystalline solutions. We improved the adjust knob for a quick and precise volume setting. On top, we added the built-in recalibration mechanism.



Perfect air-purging mechanism for 0% reagent loss

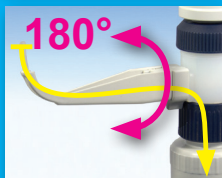

100% drip-free system for your safety



360°-turn for your added safety



“Do-it-yourself” recalibration for a long life time



Liquid Handling



different sizes available from 2.5ml up to 250ml
more information at www.witeg.de

Refrigerator

SMART-Lab™

Laboratory
Blood bank
Pharmaceutical

NEW

Anytime - Anywhere connected laboratory



SMART-Lab™ controller

7" touch screen
WiRe™ App service (remote control)
push alarm service
and many more...



Door locking system

for safe storage of all probes



Forced-air refrigeration

superior temperature

Auto-defrost system



Shelves

easy storage and classification
of samples in the refrigerator
convenient for cleaning and
maintenance processes due to
PTFE-coating



Castors for easy movement



Laboratory refrigerator



- Smart-Lab™ Steuerung
- 0°C - +10°C
- 620 l or 1,140 l
- 6 / 12 shelves (acc. to model)
- wire shelves

Blood bank



- 0°C - +10°C
- 620 l or 1,140 l
- perforated drawer shelves

Pharmaceutical refrigerator



- 0°C - +10°C
- 620 l or 1,140 l
- PTFE-coated wire shelves

SMART-Lab™



- full touch screen TFT LCD:
- WiRe™ app service, remote control system
- variable program settings
- self-diagnosis and interactive temperature graph
- automatic data recording and password protection
- data transfer to PC by USB memory
- digital calibration (offset function)
- min-/max-temperature memory & program function
- push-alarm service to smartphone or tablet PC

more information on page 8 - 11

Refrigerator

NEW

Laboratory refrigerator, Smart-Lab™ controller, 0-10°C, PTFE-coated wire shelves



PTFE-coated shelves



SMART-Lab™ controller



WiRe™ app service

LR laboratory, PTFE-coated shelves

Ideal for:

- laboratory refrigeration

Features:

- CFC free refrigerant (R-404A)
- intelligent control of refrigerator for preventing overload of compressor
- pre-set points to warn of temperature deviation at +5.5°C or -1.5°C
- built-in battery for power failure alarm
- automatic condensate removal, no drain line required
- PTFE-coated wire shelves (6 or 12 acc. to model)
- stainless steel interior and powder-coated steel body
- optional built-in chart recorder & remote alarm system
- double fold tempered glass window
- castors for easy movement
- CE certified and unique serial number for tracing

Safety mechanism:

- overheat and over-current protection
- push alarm service to your smartphone
- sensor error detection
- door locking system
- door open error
- door ajar and power failure alarm

Controller:

- **Smart-Lab™ controller** with 7" full touch screen TFT LCD:
 - ◆ WiRe™ app service, remote control system
 - ◆ variable program settings
 - ◆ self-diagnostic function
 - ◆ automatic data recording
 - ◆ data transfer to PC by USB memory
 - ◆ Internet connectivity with WiFi



LR-1000 with 12 PTFE-coated shelves (included)

LR-600 with 6 PTFE-coated shelves (included)

Model	SmartLab™ laboratory refrigerator	
	LR-600	LR-1000
Capacity	620 l	1140 l
Temperature range & sensor	0°C - +10°C (at 30°C room temperature & 30% humidity), PT 100 sensor	
Temperature resolution	control: ±1.0°C, display: ±1.0°C	
Compressor	250 W	
Evaporator	auto exchange dual evaporator	
Defrost & circulation	automatic defrost and melt water evaporation, dual turbo fan forced-air circulation	
Shelves	6 x PTFE-coated steel wire shelves, height adjustable	12 x PTFE-coated steel wire shelves, height adjustable
Internal dimensions (W x D x H)	620 x 700 x 1430 mm	1140 x 700 x 1430 mm
External dimensions (W x D x H), net weight	740 x 805 x 1930 mm, 134 kg	1260 x 805 x 1930 mm, 208 kg
Packing size (W x D x H), gross weight	1000 x 900 x 2140 mm, 184 kg	1510 x 1240 x 2200 mm, 278 kg
Power supply	1 Phase AC 120V, 60 Hz or AC 230V, 50/60 Hz	
Power consumption	650 W	750 W
Order number 230V	DH.REFL0600	DH.REFL1000
Order number 120V	DH.REFL0601	DH.REFL1001

Accessories: Suitable shelves can be found on page 94

NEW

Refrigerator

Blood bank or pharmaceutical refrigerator, 0-10°C, drawer- or wire shelves

**BR** Blood bank, drawer shelves**PR** Pharm. refrigerator, wire shelves**Ideal for:**

- blood bank- & pharmaceutical refrigeration

Features:

- CFC free refrigerant (R-404A)
- intelligent control of refrigerator for preventing overload of compressor
- built-in battery for power failure alarm
- automatic condensate removal, no drain line required
- wire shelves for PR-models (6 or 12 pcs. acc. to model)
- drawer shelves for BR-model (6 or 12 pcs. acc. to model)
- stainless steel interior and powder-coated steel body
- optional built-in chart recorder & remote alarm system
- double fold tempered glass window
- castors for easy movement
- CE certified and unique serial number for tracing

Safety mechanism:

- overheat and over-current protection
- sensor error detection
- door locking system
- power failure alarm

Controller:

- *digital PID controller*



Model	Blood bank refrigerator		Pharmaceutical refrigerator	
	BR-600	BR-1000	PR-600	PR-1000
Capacity	620 l	1140 l	620 l	1140 l
Temperature range & sensor	0°C - +10°C (at 30°C room temperature & 30% humidity), PT 100 sensor			
Temperature resolution	control: 1.0°C, display: 1.0°C			
Compressor	250 W			
Evaporator	auto exchange dual evaporator			
Defrost & circulation	automatic defrost and melt water evaporation, dual turbo fan forced-air circulation			
Shelves	6 x drawer shelves	12x drawer shelves	5 x wire shelves	10x wire shelves
Internal dimensions (W x D x H)	620 x 700 x 1430 mm	1140 x 700 x 1430 mm	620 x 700 x 1430 mm	1140 x 700 x 1430 mm
External dimensions (W x D x H), net weight	740 x 805 x 1930 mm, 134 kg	1260 x 805 x 1930 mm, 208 kg	740 x 805 x 1930 mm, 134 kg	1260 x 805 x 1930 mm, 208 kg
Power supply	1 Phase AC 120V, 60 HZ or AC 230V, 50/60 Hz			
Power consumption	650 W	750 W	650 W	750 W
Order number 230V	DH.REFB0600	DH.REFB1000	DH.REFP0600	DH.REFP1000
Order number 120V	DH.REFB0601	DH.REFB1001	DH.REFP0601	DH.REFP1001

Accessories: Suitable shelves can be found on page 94

Refrigerator

Accessories: Shelves

Alarm system

- suitable for refrigerator LR, PR, BR

Article	Order number
RWAS	DH.RWAS



Temperature recorder

- suitable for refrigerator LR, PR, BR

	Order number
with chart paper and replacement pen (red, 7 day recording)	DH.KT622
spare chart paper, 60 pcs. (420 days of recording)	DH.C657
replacement pens (red), 6 pcs.	DH.P222

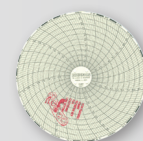

PTFE-coated steel wire shelves

- suitable for refrigerator LR, PR

For device...	Measurements	Order number
LR-600, PR-600	600 x 624 mm	DH.REFA0003
LR-1000, PR-1000	560 x 624 mm	DH.REFA0004



Drawer shelves, Edelstahl

- suitable for refrigerator BR

For device...	Measurements	Order number
BR-600	570 x 570 mm	DH.REFA0007
BR-1000	470 x 570 mm	DH.REFA0008



Refrigerator
LR | PR | BR

Freezer

SMART-Lab™ upright-type personal-type

UniFreeze™ system

Single compressor ensures temperatures down to -86°C , minimized power consumption and minimized noise level.

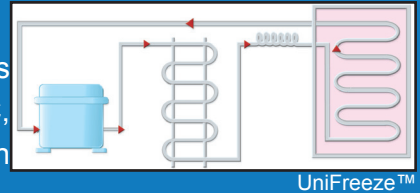

DuoFreeze™ system

The combination of a doubled UniFreeze™ system ensures temperatures down to -95°C . The second system also acts as backup system.

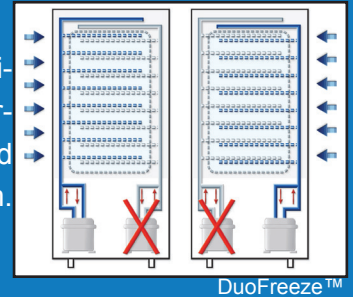

Time taken to reach low temperature:

upright-type	UniFreeze™					DuoFreeze™			
	SWUF-80	SWUF-300	SWUF-400	SWUF-500	SWUF-700	SWUF-D300	SWUF-D400	SWUF-D500	SWUF-D700
Capacity	82 l	308 l	393 l	503 l	714 l	308 l	393 l	503 l	714 l
Down to -80°C	170 min	270 min	250 min	310 min	430 min	140 min	150 min	160 min	250 min

tested with room temperature of 30°C - 33°C

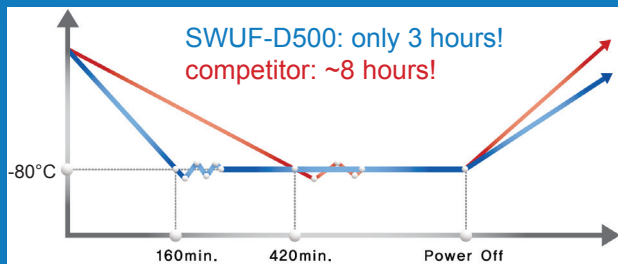

Green product

RoHs certified

No hazardous substances (Pb, Cd, Hg, Hex-Cr, PBB, PBDE) are used in all UniFreeze™ and DuoFreeze™ freezers!

Natural refrigerants

Instead of using HFC refrigerants (R-134a, R-404A, R-507) all UniFreeze™ and DuoFreeze™ models have a specially mixed refrigerant mostly consisting of natural materials.

Power consumption

UniFreeze™ SWUF-D500	Savings	Competitor (typical)
4,015 kWh/year	39%	6,570 kWh/year
1,963 kgCO ₂ /year		3,212 kgCO ₂ /year

calculated by the electricity-specific emission factors sourced from the IEA (2011a).

SMART-Lab™



- full touch screen TFT LCD:
- WiRe™ app service, remote control system
- variable program settings
- self-diagnosis and interactive temperature graph
- automatic data recording and password protection
- data transfer to PC by USB memory
- digital calibration (offset function)
- min-/max-temperature memory & program function
- push-alarm service to smartphone or tablet PC

more information on page 8 - 11

IQ | OQ
available

Validation | IQ & OQ - page 12 for details

Freezer

upright-type, UniFreeze™ system, SmartLab™ controller, down to -86°C, 308 / 393 / 503 / 714 l



SMART-Lab™ controller



WiRe™ app service



UniFreeze™
Simplified Hi-Efficiency Freezing System

SWUF -86°C, UniFreeze

Ideal for:

- ultra low refrigeration

Features:

- CFC free refrigerant (R-404A)
- UniFreeze™ system
- automatic vacuum breaker – easy to re- open door
- external temperature sensor hole
- block condenser removes filter & causes of related failure
- filter-free mechanism lowers heat from the compressor
- easy maintenance and improved performance
- high-quality insulation panel and inner doors ensure defrosting around outer surface
- easy monitoring and control – eye level controller
- stainless steel interior, powder-coated steel body and inner door
- 3x stainless steel shelves to separate chamber into 4 sub-chambers included
- castors for easy movement
- UL/CUL, CE & RoHS certified and unique serial number for tracing

Safety mechanism:

- push alarm service to your smartphone
- sensor error detection
- door locking system, door open error
- door ajar and power failure alarm
- standard warning and alarm functions

Controller:

- **Smart-Lab™ controller** with 7" full touch screen TFT LCD:
 - ◆ WiRe™ app service, remote control system
 - ◆ variable program settings
 - ◆ self-diagnostic function
 - ◆ automatic data recording
 - ◆ data transfer to PC by USB memory
 - ◆ Internet connectivity with WiFi



SWUF-300 & 3x stainless steel shelves (included)

Model	SWUF-300	SWUF-400	SWUF-500	SWUF-700
Capacity	308 l	393 l	503 l	714 l
Temperature range & sensor	-86°C to -65°C			-80°C to -65°C
	at 30°C room temperature & 30% humidity, PT 100 sensor			
Compressor	Hermetic type			
Condenser type	block condenser, no pin, filter-free			
Max. rack quantity	12 pcs. of 15 (3x5) placed racks (RFU3040)	16 pcs. of 15 (3x5) placed racks (RFU3040)	16 pcs. of 20 (4x5) placed racks (RFU50)	24 pcs. of 20 (4x5) placed racks (RFU50)
Internal chamber dimensions (W x D x H)	470 x 500 x 1310 mm	600 x 500 x 1310 mm	600 x 640 x 1310 mm	880 x 620 x 1310 mm
External chamber dimensions (W x D x H), net weight	710 x 750 x 1900 mm 190 kg	840 x 750 x 1900 mm 210 kg	840 x 890 x 1900 mm 240 kg	1120 x 870 x 1900 mm 320 kg
Packing size (W x D x H), gross weight	110 x 110 x 222 cm 275 kg	116 x 116 x 222 cm 296 kg	116 x 124 x 222 cm 327 kg	140 x 140 x 221 cm 442 kg
Power supply	1 Phase AC 120V, 60 Hz or AC 230V, 50/60 Hz			
Power consumption	352 w/h	373 w/h	458 w/h	503 w/h
Order number 230V	DH.SWUF00300	DH.SWUF00400	DH.SWUF00500	DH.SWUF00700
Order number 120V	DH.SWUF03300	DH.SWUF03400	DH.SWUF03500	DH.SWUF03700

Accessories: Suitable racks and temperature recorder can be found on page 101

upright-type, DuoFreeze™ system, SmartLab™ controller, down to -95°C, 308 / 393 / 503 / 714 l



SMART-Lab™ controller

WiRe™ app service

DuoFreeze™

SWUF-D -95°C, DuoFreeze

Ideal for:

- ultra low refrigeration

Features:

- CFC free refrigerant (R-404A)
- DuoFreeze™ with 2 compressors: when one system fails, the other still cools down to -80°C
- automatic vacuum breaker – easy to re- open door
- external temperature sensor hole
- block condenser removes filter and causes of related failure
- filter-free mechanism lowers compressor heat
- easy maintenance and improved performance
- high-quality insulation panel and inner doors ensure defrosting around outer surface
- easy monitoring and control – eye level controller
- stainless steel interior, powder-coated steel body and inner door
- 3x stainless steel shelves to separate chamber into 4 sub-chambers included
- castors for easy movement
- UL/CUL, CE and RoHS certified and unique serial number for tracing
- SWUF-D500 model is GMP certified

Safety mechanism:

- push alarm service to your smartphone
- sensor error detection
- door locking system, door open error
- door ajar and power failure alarm
- standard warning and alarm functions

Controller:

- **Smart-Lab™ controller** with 7" full touch screen TFT LCD:
 - ◆ WiRe™ app service, remote control system
 - ◆ variable program settings
 - ◆ self-diagnostic function
 - ◆ automatic data recording
 - ◆ data transfer to PC by USB memory
 - ◆ Internet connectivity with WiFi



IQ | OQ
available
page 12 for details

SWUF-D300 & 3x stainless steel shelves (included)

Model	SWUF-D300	SWUF-D400	SWUF-D500	SWUF-D700
Capacity	308 l	393 l	503 l	714 l
Temperature range & sensor	-95°C to -65°C			-90°C to -65°C
	at 30°C room temperature & 30% humidity, PT 100 sensor			
Compressor	Hermetic type			
Condenser type	block condenser, no pin, filter-free			
Max. rack quantity	12 pcs. of 15 (3x5) placed racks (RFU3040)	16 pcs. of 15 (3x5) placed racks (RFU3040)	16 pcs. of 20 (4x5) placed racks (RFU50)	24 pcs. of 20 (4x5) placed racks (RFU50)
Internal chamber dimensions (W x D x H)	470 x 500 x 1310 mm	600 x 500 x 1310 mm	600 x 640 x 1310 mm	880 x 620 x 1310 mm
External chamber dimensions(W x D x H), net weight	710 x 750 x 1900 mm, 220 kg	840 x 750 x 1900 mm, 260 kg	840 x 890 x 1900 mm, 300 kg	1120 x 870 x 1900 mm, 320 kg
Packing size (W x D x H), gross weight	110 x 110 x 222 cm, 300 kg	116 x 116 x 222 cm, 352 kg	116 x 124 x 222 cm, 352 kg	140 x 140 x 221 cm, 442 kg
Power supply	1 Phase AC 120V, 60 Hz or AC 230V, 50/60 Hz			
Power consumption dual mode	398 w/h	474 w/h	507 w/h	596 w/h
Power consumption eco mode	352 w/h	373 w/h	458 w/h	503 w/h
Order number 230V	DH.SWUF01300	DH.SWUF01400	DH.SWUF01500	DH.SWUF01700
Order number 120V	DH.SWUF02300	DH.SWUF02400	DH.SWUF02500	DH.SWUF02700

Accessories: Suitable racks and temperature recorder can be found on page 101

Freezer

personal-type, UniFreeze™ system, SmartLab™ controller, down to -86°C, 82 l

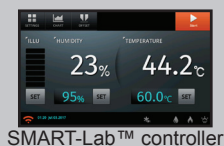

SWUF-80 -86°C, UniFreeze™

Ideal for:

- ultra low refrigeration

Features:

- personal-type compact ultra-low temperature freezer
- freeze down to -86°C
- CFC-free refrigerant
- external temperature sensor hole
- block condenser removes filter
- filter-free mechanism lowers compressor heat
- easy maintenance and improved performance
- high-quality insulation panel and inner doors (powder-coated stainless steel) ensure defrosting around outer surface
- stainless steel interior & powder-coated steel body
- CE, UL/CUL & RoHS certified and unique serial number for tracing

Safety mechanism:

- push alarm service to your smartphone
- sensor error detection
- door locking system, door open error
- door ajar and power failure alarm
- standard warning and alarm functions

Controller:

- **Smart-Lab™ controller** with 7" touch screen TFT LCD:
 - ◆ WiRe™ app service, remote control system
 - ◆ variable program settings
 - ◆ self-diagnostic function
 - ◆ automatic data recording
 - ◆ data transfer to PC by USB memory
 - ◆ Internet connectivity with WiFi

IQ | OQ
available
page 12 for details



SWUF-80



different racks available

Model	SWUF-80
Capacity	82 l
Temperature range & sensor	-86°C to -65°C, at 30°C room temperature & 70% humidity, PT 100 sensor
Compressor	Hermetic type
Condenser type	block condenser, no pin, filter-free
Shelves	1 stainless steel shelf included
Max. rack quantity	4 pcs. of 12 (3x4) placed rack (RFU8)
Internal dimensions (W x D x H)	340 x 485 x 520 mm
External dimensions (W x D x H), net weight	530 x 687 x 1060 mm, 60 kg
Packing size (W x D x H), gross weight	960 x 760 x 1350 mm, 102 kg
Power supply	1 Phase AC 120V, 60 Hz or AC 230V, 50/60 Hz
Power consumption	321 w/h
Order number 230V	DH.SWUF0075
Order number 120V	DH.SWUF0175

Accessories: Suitable racks and temperature recorder can be found on page 101

personal-type, UniFreeze™ system, digital feedback controller, down to -86°C, 82 l



digital feedback controller



IQ | OQ
available
page 12 for details



WUF-25

WUF-25 -86°C, UniFreeze™

Ideal for:

- ultra low refrigeration

Features:

- personal-type compact ultra-low temperature freezer
- freeze down to -86°C
- CFC-free refrigerant
- external temperature sensor hole
- use of block condenser removes filter
- filter-free mechanism lowers compressor heat
- easy maintenance and improved performance
- high-quality insulation panel and inner doors (powder-coated stainless steel) ensure defrosting around outer surface
- stainless steel interior & powder-coated steel body
- CE & RoHS certified and unique serial number for tracing

Safety mechanism:

- built-in standard warning and alarm functions

Controller:

- **digital** feedback controller

Model	WUF-25
Capacity	25 l
Temperature range & sensor	-86°C to -65°C, at 30°C room temperature & 70% humidity, PT 100 sensor
Compressor	Hermetic type
Condenser type	block condenser, no pin, filter free
Shelves	-
Max. rack quantity	none, only 10-15 boxes are applicable
Internal dimensions (W x D x H)	200 x 420 x 300 mm
External dimensions (W x D x H), net weight	390 x 627 x 785 mm, 52 kg
Packing size (W x D x H), gross weight	880 x 860 x 1300 mm, 69 kg
Power supply	1 Phase AC 120V, 60 Hz or AC 230V, 50/60 Hz
Power consumption	321 w/h
Order number 230V	DH.WUF0032
Order number 120V	DH.WUF0132

Freezer

upright-type laboratory freezer, -35°C, 420 l



Wise remote



Jog-Shuttle controller

IQ | OQ
available
page 12 for details

WLF-420 -35°C, 420 l

Ideal for:

- storage of bio reagent, seed, enzyme and various samples

Features:

- fast freezing function
- CFC free refrigerant (R-404A), 1 HP compressor
- intelligent control of refrigerator for preventing overload of compressor
- 3x stainless steel shelves included, 16 kg load per shelf
- stainless steel interior and powder-coated steel body
- storage function for the set values of temperature and timer
- RS232C interface for monitoring and controlling (WireRemote)
- backlight LCD display
- CE certified and unique serial number for tracing

Safety mechanism:

- locking mode
- over-current protection
- sensor error detection and leakage breaker

Controller:

- digital fuzzy controller with **Jog-Shuttle-switch** (turn + push)



WLF-420
with 2 inner doors and 3x stainless steel
shelves (included)



Model	WLF-420
Capacity	420 l
Type	upright-type
Temperature range & sensor	room temperature down to -35°C - +10°C, PT 100 sensor
Temperature resolution	control: ±1.0°C, display: ±1.0°C
Shelves	3 stainless steel shelves included, max.load per shelf 16 kg
Compressor	750 W
Internal dimensions (W x D x H)	600 x 700 x 1000 mm
External dimensions (W x D x H), net weight	800 x 800 x 1700 mm, 48 kg
Packing size & gross weight	1160 x 1060 x 2160 mm, 314 kg
Power supply	1 Phase AC 120V, 60 Hz or AC 230V, 50/60 Hz
Power consumption	1,8 kW
Order number 230V	DH.WLF00420
Order number 120V	DH.WLF01420

Spare flat shelf, stainless steel

For device...	Measurements	Article	Order number
WLF-420	580 x 680 mm	LFS420	DH.WLF10420

Freezer

Accessories: Temperature recorder, remote alarm system, shelves

Racks, stainless steel

• suitable for freezer SWUF, SWUF-D (not SWUF-80)

Type	Places	Measurements	Article	Order number
sliding drawer-type	15	140 x 430 x 290 mm	RFU3040SD	DH.RFU3040SD
	20	140 x 570 x 290 mm	RFU50SD	DH.RFU50SD
side access-type	15	140 x 430 x 290 mm	RFU3040SA	DH.RFU3040SA
	20	140 x 570 x 290 mm	RFU50SA	DH.RFU50SA

delivered without cryo-boxes; maximal height of cryo-box: 55mm



Racks, stainless steel

• suitable for freezer SWUF-80

Type	Places	Measurements	Article	Order number
sliding drawer-type	12	140 x 430 x 220 mm	RFU8SD	DH.RFU8SD
side access-type	12	140 x 430 x 220 mm	RFU8SA	DH.RFU8SA

delivered without cryo-boxes; maximal height of cryo-box: 55mm



Cryo-boxes 136x136 mm, white, water repellent cardboard

• suitable for all freezer racks

Height: 32 mm	Height: 50 mm
5 486 000	5 486 005

Grids for cryo-boxes 136x136 mm, white, water repellent cardboard

• suitable for all cryo-boxes (please consider height of cryo-box)

Height	4x4	5x5	6x6	7x7	8x8	9x9	10x10	12x12
25 mm	5 486 100	5 486 105	5 486 110	5 486 115	5 486 140	5 486 145	5 486 150	5 486 155
30 mm	5 486 101	5 486 106	5 486 111	5 486 116	5 486 141	5 486 146	5 486 151	5 486 156
40 mm	5 486 102	5 486 107	5 486 112	5 486 117	5 486 142	5 486 147	5 486 152	5 486 157

Cryovials can be found on page 239



Freezer all models

Remote alarm system

• suitable for freezer SWUF, SWUF-D, SWUF-80, WUF-25

Article	Order number
RWAS	DH.RWAS



Temperature recorder

• suitable for freezer SWUF, SWUF-D, SWUF-80, WUF-25

Description	Order number
recorder with chart paper and replacement pen (red)	DH.KT622
spare chart paper, 60 pcs. (420 days of recording)	DH.C657
replacement pens (red), 6 pcs.	DH.P222



Freeze dryer

-60° down to -90°C, many accessories available



FD-8 with 12 port T-type manifold (not included)

FD-8 -60° down to -90°C

Ideal for:

- wide range from pharmaceuticals, biology, food industry to petrol-chemistry and semiconductor industry, etc.

Features:

- ergonomic design and compact body size for all laboratory tables
- allows automatic or manual process control
- temperature, vacuum and timer can be controlled at automatic mode
- rapid integrated hot gas defrost function for quick next cycle turn-around
- LED indication light in case of suitable temperature and vacuum
- homogeneous temperature distribution across all shelves in dry chamber
- made of stainless steel
- backlight LCD display indicates temperature and vacuum
- CE certified and unique serial number for tracing

Controller:

- digital fuzzy controller with **Jog-Shuttle-switch** (turn + push) and touch button

Model	FD-8
Chamber & max. condenser capacity	chamber: 8 l, max. condenser: 10 l
Sublimation rate	3 l/day
Max. temperature	cold trap: -90°C, condenser: -40°C
Set temperature range	-60°C to -90°C
Pressure range	10 - 0.01 torr
Compressor and defrost type	compressor: 1/2 HP, defrost type: manual
Dimensions (W x D x H) & weight	400 x 530 x 415 mm, condenser: Ø 300 x 150 mm, 55 kg
Packing size & gross weight	560 x 760 x 675 mm, 60 kg
Power supply	1 Phase AC 120V, 60 Hz or AC 230V, 50/60 Hz
Order number 230V	DH.Frd00208
Order number 120V	DH.Frd00108



Recommended vacuum pump: Rocker 800

Model	Rocker 800	
	120V / 60Hz	230V / 50Hz
Max. vacuum	-670 mmHg	
Max. flow rate	100 l/min	84 l/min
Motor rotation	1750 rpm	1450 rpm
Horse power	1/3 HP	
Noise level	68 dB	
Port thread	3/8 inch (10 mm)	
Order number	00829 167800-11	00829 167800-22

more information on page 190



Accessories

Various accessories available such as manifolds, dry chambers or shelves.

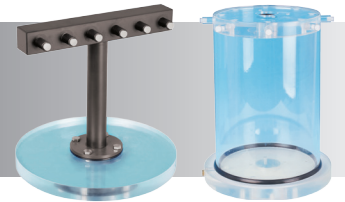

Controller

Intuitive touch-button controller (Jog-Dial).
Indication LEDs for temperature and vacuum.

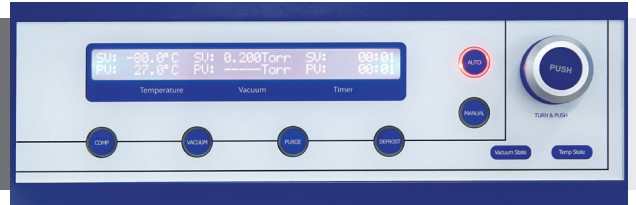

Freezing system

Quick freezing and defrosting function.



made of Duran® tubing



Description	Order number
40ml flask, Ø40/2.3t x h80mm	DH.GL12041
80ml flask, Ø40/2.3t x h120mm	DH.GL12042
200ml flask, Ø65/2.2t x h100mm	DH.GL12043
300ml flask, Ø65/2.2t x h140mm	DH.GL12044
500ml flask, Ø90/2.5t x h125mm	DH.GL12045
700ml flask, Ø90/2.5t x h165mm	DH.GL12046
1000ml flask, Ø90/2.5t x h225mm	DH.GL12047



Description	Order number
Table cart, 2 stages, for FD-8 and pump	DH.Ca1002

Description	Order number
T-type manifold, 12 ports, 3/4" vacuum handle valve, incl. 10x silicone stopper	DH.Frd01034



Description	Order number
Dry chamber, acrylic, 8 ports, 3/4" vacuum handle valve, incl. 10x silicone stopper	DH.Frd02010



Description	Order number
Shelve, 3 stages, stainless steel, for dry chamber DH.Frd02010	DH.Frd02020



Description	Order number
Vacuum handle valve, 3/4", neoprene rubber and PP	DH.Frd03010



Description	Order number
Glass tube adapter, 3/4", Ø19/1.8t x L80mm	DH.GL28091
Glass tube adapter bent-type, 3/4", Ø19/1.8t x L80mm	DH.GL28092
PP tube adapter bent-type, 3/4", Ø19/1.8t x L80mm	DH.Frd04010

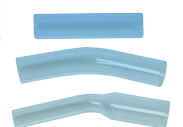

Description	Order number
Flask top, silicone, 3/4", for 40/80 ml flasks	DH.Frd05010
Flask top, silicone, 3/4", for 200/300 ml flasks	DH.Frd05020
Flask top, silicone, 3/4", for 500/700/1000 ml flasks	DH.Frd05030



... more from witeg

Consumables

Beaker, flasks, bottles
and many more...

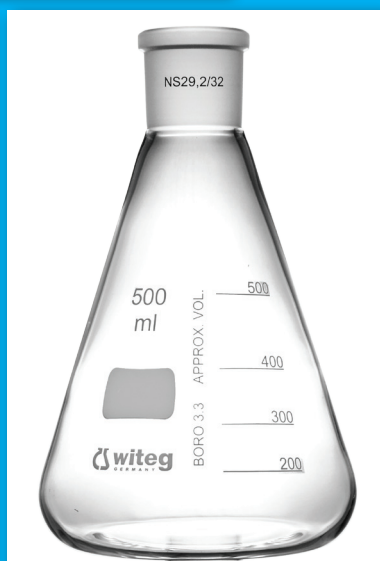
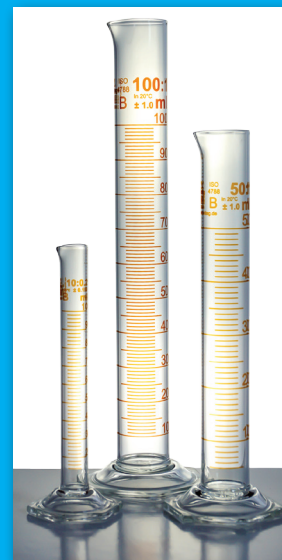

Beaker

- many different sizes
 - with or without spout
 - tall and low form
 - Duran® and Borosilicate glass 3.3
- more information on page 223

Erlenmeyer flasks

- many different sizes
 - with socket or screw thread
 - clear glass or amber stained
 - Borosilicate glass 3.3
- more information on page 224

Volumetric flasks

- many different sizes
 - class A, B and USP
 - with socket or screw thread
 - clear glass or amber stained
 - Borosilicate glass 3.3
- more information on page 220

Tubes

- many different sizes
 - test & centrifuge tubes
 - rim and screw thread
 - Borosilicate glass 3.3
- more information on page 236

Laboratory bottles

- wide or narrow neck
 - with socket or screw thread
 - clear glass or amber stained
 - Duran® and Borosilicate glass 3.3
- more information on page 228

Graduated cylinder

- many different sizes
 - class A, B and USP
 - with socket or screw thread
 - clear glass or amber stained
 - Borosilicate glass 3.3
- more information on page 226

and more

- racks and trays
 - crucibles
 - weighing accessories
 - brushes
 - staining jars
 - petri dishes
- more information starting from page 241

MIXING & SHAKING



MIXING & SHAKING

Magnetic stirrer with hotplate.....	22
Dry bath (Incubator).....	30
Bath (shaking)	55
Incubator (shaking).....	66
Magnetic stirrer.....	107
Jar tester.....	111
Overhead stirrer.....	112
Homogenizer	122
Vortex mixer.....	126
Shaker	128
Rotator.....	133
Rocker	134
Ball mill	135

Magnetic stirrer

MS-500D

NEW

Highest performance

- powerful: stirring capacity up to 20 l, stirring rate up to 1,500 rpm
- protection against corrosion due to the smart design
- strong but quiet motor, made for a long life time

Highest convenience

- intuitive and very easy to use control elements
- illuminated digital display for easy setting
- easy to clean full ceramic plate

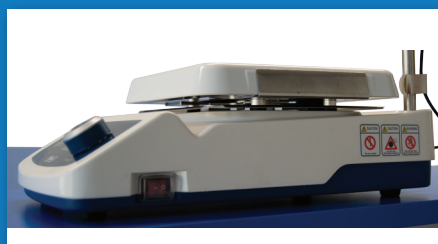

Protection

Two features protect the device from internal corrosion and prolong its life time: the **closed coverage type** and the **intelligent fluid management system**, which leads off accidentally spilled liquids away from the interior of the device.

Surface

The superior full ceramic plate is resistant against aggressive chemicals and easy to clean.



Motor

The brushless shade motor ensures strong and precise stirring, minimized noise and a long life time. Due to the high-performance magnet, up to 20 l of water can be stirred easily.

Controller

New Jog-Dial "Turn + Push" and touch button are designed for intuitive, easy and direct use.



NEW

Magnetic stirrer

digital display, 80-1,500 rpm, solid ceramic plate 200x200 mm

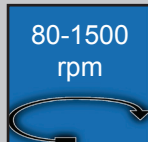
80-1500
rpm

MS-500D digital

Ideal for:

- mixing of chemical, laboratory and pharmaceutical materials

Features:

- digital display with backlight
- brushless shade motor for 80-1,500 rpm
- enormous strength of magnet
- high-quality solid ceramic plate 200x200 mm
- heat-, chemical- and acid-resistant
- no liquid can get into the body
- powder-coated aluminium body
- 30 mm stirrer bar included
- CE certified and unique serial number for tracing

Safety mechanism:

- timer 99h 59min with timer-end signal
- error status
- locking mode
- operation LEDs

Controller:

- **Jog-Dial** controller with touch-button for precise speed control

Stirrer bar included



Model	MS-500D
Body	powder-coated aluminium
Plate	solid ceramic plate, 200x200 mm
Stirring capacity	max. 20 l
Speed & control resolution	80 ~ 1,500 rpm, 5 rpm
Timer & alarm	99hr 59min (with continuous run), error status and timer-end
Display	digital LCD with backlight function
Controller	digital feedback controller with Jog-Dial (Turn+Push) and touch-button
Stirring bar	30 mm bar included, usable up to 50 mm bar
Permissible temperature & RH %	ambient temperature +5 ~ 50°C, 85% RH
Dimension & weight	205x345xh135 mm, 3.3 kg
Packaging size	400x280xh160 mm, 5.2 kg
Power supply	1 Phase AC 120V, 60 Hz or AC 230V, 50/60 Hz
Order number 230V	DH.WMS04022
Order number 120V	DH.WMS05022

Accessories: External temperature probes, stand rod, stirring bars and holder / clamp / clip on page 27 & 28

Magnetic stirrer

digital, 80-1,500 rpm, ceramic-coated plate 180x180 mm

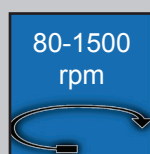

Stirrer bar included

MS-20D digital

Ideal for:

- mixing of chemical, laboratory and pharmaceutical materials

Features:

- digital display with backlight
- shade motor for 80-1,500 rpm
- ceramic-coated aluminium plate 180x180 mm
- heat-, chemical- and restricted acid-resistant
- powder-coated aluminium body
- 30 mm stirrer bar included
- CE certified and unique serial number for tracing

Safety mechanism:

- timer 99h 59min with timer-end signal
- error status
- locking mode
- operation LEDs

Controller:

- **Jog-Shuttle** controller with touch-button

Model	MS-20D
Body	powder-coated aluminium
Plate	ceramic-coated aluminium (heat-, chemical- and acid-resistant), 180x180 mm
Stirring capacity	max. 20 l
Speed & control resolution	80 ~ 1,500 rpm, 5 rpm
Timer & alarm	99hr 59min (with continuous run), error status and timer-end
Display	digital LCD with backlight function
Controller	digital feedback controller with Jog-Shuttle Switch (Turn+Push)
Stirring bar	30 mm bar included, usable up to 50 mm bar
Permissible temperature & RH %	ambient temperature +5 ~ 50°C, 85% RH
Dimension & weight	206x307xh99 mm, 3.1 kg
Packaging size	400x280xh200 mm, 5 kg
Power supply	1 Phase AC 120V, 60 Hz or AC 230V, 50/60 Hz
Order number 230V	DH.WMS03022
Order number 120V	DH.WMS02022

Accessories: External temperature probes, stand rod, stirring bars and holder / clamp / clip on page 27 & 28

Magnetic stirrer

analog, up to 1,500 rpm, ceramic-coated plate 180x180 mm

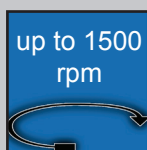

MS-20A analog

Ideal for:

- mixing of chemical, laboratory and pharmaceutical materials
- heat-sensitive procedures in microbiology and biochemistry

Features:

- up to 1,500 rpm
- ceramic-coated aluminium plate 180x180 mm
- heat-, chemical- and restricted acid-resistant
- powder-coated aluminium body
- 30 mm stirrer bar included
- CE certified and unique serial number for tracing

Safety mechanism:

- operation LEDs

Controller:

- **PWM controller**



Stirrer bar included

Model	MS-20A
Body	powder-coated aluminium
Plate	ceramic-coated aluminium (heat-, chemical- and acid-resistant), 180x180 mm
Stirring capacity	max. 20 l
Speed	up to 1,500 rpm
Controller	superior linearity PWM Controller
Stirring bar	30 mm bar included, usable up to 50 mm bar
Permissible temperature & RH %	ambient temperature +5 ~ 50°C, 85% RH
Dimension & weight	206x307xh99 mm, 3.1 kg
Packaging size	400x280xh200 mm, 5 kg
Power supply	1 Phase AC 120V, 60 Hz or AC 230V, 50/60 Hz
Order number 230V	DH.WMS03122
Order number 120V	DH.WMS02122

Magnetic stirrer

digital, multi-point (4 and 8 places), 80-1,200 rpm, stainless steel plate



MS-MP multi-type digital

Ideal for:

- multiple mixing applications at the same time
- mixing of chemical, laboratory and pharmaceutical materials

Features:

- 80-1,200 rpm
- aluminium plate with 2x2 or 4x2 places
- heat-, chemical- and acid-resistant
- easy to clean
- powder-coated steel body
- stirrer bar included
- CE certified and unique serial number for tracing

Safety mechanism:

- timer 99h 59min with timer-end signal
- error status
- locking mode
- operation LEDs

Controller:

- **Jog-Shuttle** controller with touch-button

Model	MS-MP4	MS-MP8
Stirring points	4 (2x2)	8 (4x2)
Body	powder-coated steel (heat-, chemical- and acid-resistant)	
Plate	stainless steel (#304)	
Plate size	210x300 mm	210x500 mm
Distance between points	100 mm	
Stirring capacity	0.5 l per point	
Speed & control resolution	80 ~ 1,200 rpm, 5 rpm	
Timer & alarm	99hr 59min (with continuous run), error status and timer-end	
Display	digital LCD with backlight function	
Controller	digital feedback controller with Jog-Shuttle Switch (Turn+Push)	
Stirring bar	4x 30 mm bar included, usable up to 30 mm bar	8x 30 mm bar included, usable up to 30 mm bar
Permissible temperature & RH %	ambient temperature +5 ~ 50°C, 85% RH	
Dimension & weight	210x300x65 mm, 2.5 kg	210x500x65 mm, 3.5 kg
Packaging size	330x300xh180 mm, 6 kg	540x330xh180 mm, 6 kg
Power supply	1 Phase AC 120V, 60 Hz or AC 230V, 50/60 Hz	
Order number 230V	DH.WMS03036	DH.WMS03038
Order number 120V	DH.WMS02036	DH.WMS02038

Accessories: External temperature probes, stand rod, stirring bars and holder / clamp / clip on page 27 & 28

Jar tester

6-paddle stirrer, 20 - 300 rpm, individual light sources, programmable

20-300 rpm

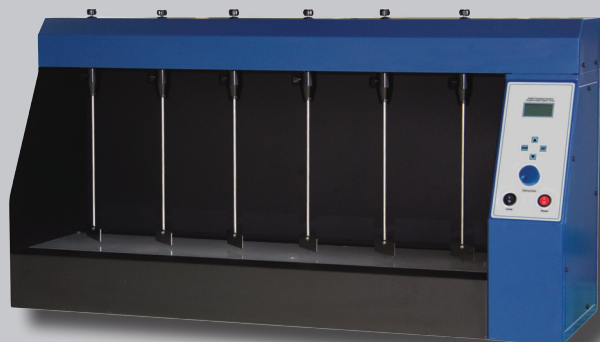

JT-M6C



Timing belt

JT-M6C

Ideal for:

- flocculation test in water treatment laboratories
- coagulation chemistry

Features:

- 20 - 300 rpm
- 6 places
- 6 light sources
- programmable operations (6 programs with 10 steps)
- geared motor (ratio: 10:1)
- digital LCD for rpm, power-bar, status and programming
- special designed timing belt
- CE certified and unique serial number for tracing

Safety mechanism:

- timer 99h 59min with timer-end signal
- error status
- locking mode
- overload protection
- overheat protection
- operation LEDs

Controller:

- programmable digital feedback controller with **Jog-Shuttle switch** (turn + push)

Model	JT-M6C
Stirring points	6
Paddler	Ø8 x L400 mm, straight blade w75xh25 mm
Stirring capacity (H ₂ O)	6x 1 l beaker
Speed range	20-300 rpm, ±5 rpm (geared DC motor 10:1 ratio, 40 W)
Timer & alarm	99hr 59min (with continuous run), error status and timer-end
Controller	digital Feedback Controller with Jog-Shuttle (Turn+Push)
Controller feature	programmable, 6 programs, 10 steps
Display	digital LCD with backlight function
Florescent lamp	6x 20W (light sources)
Safety device	overheat & overload protection
Dimension & weight	1,000x310x535 mm, 37 kg
Packaging size	1,120x430x740 mm, 69 kg
Power supply	1 Phase AC 120V, 60 Hz or AC 230V, 50/60 Hz
Order number 230V	DH.WJT06020
Order number 120V	DH.WJT06021

Accessories: Impellers on page 124

Overhead stirrer

High-speed
High-torque



Model overview & comparison

Model	High-speed						High-torque					
	Analog		Digital				Analog		Digital			
	Integrated controller		Integrated controller		Remote controller		Integrated controller		Integrated controller		Remote controller	
	HS-50A	HS-120A	HS-30D	HS-100D	HS-30T	HS-100T	HT-50AX	HT-120AX	HT-50DX	HT-120DX	HT-50T	HT-120T
Max. stirring capacity (H ₂ O)	10 l	20 l	10 l	20 l	10 l	20 l	40 l	60 l	40 l	60 l	40 l	60 l
Max. viscosity (mPas)	10,000	50,000	10,000	50,000	10,000	50,000	100,000	150,000	100,000	150,000	100,000	150,000
Motor rating (input / output)	83/75 W (1/10 hp)	130/120 W (1/6 hp)	83/75 W (1/10 hp)	130/120 W (1/6 hp)	83/75 W (1/10 hp)	130/120 W (1/6 hp)	83/75 W (1/10 hp)	130/120 W (1/6 hp)	83/75 W (1/10 hp)	130/120 W (1/6 hp)	83/75 W (1/10 hp)	130/120 W (1/6 hp)
Max. torque (Ncm) at chuck	85	145	85	145	85	145	300	500	300	500	300	500
Max. impeller diameter	8 mm						10 mm					
Speed range (rpm)	200 - 3,000 rpm						50 - 1,000 rpm					
Motor rating	Direct driven motor						3.5 : 1 ratio; worm-gear motor					
Controller	Analog phase		Jog-Shuttle		Jog-Shuttle via remote		Analog phase		Jog-Shuttle		Jog-Shuttle via remote	
Display	-		Digital LCD (for timer, rpm and power)				-		Digital LCD (for timer, rpm and power)			
Operation environment	Temperature range: 0 - 40°C, maximal humidity: 80%											
Safety mechanism	overheat protection		overheat and overload protection				overheat protection		overheat and overload protection			
Dimensions (WxDxH mm)	90x145x180				90x100x180		90x180x130	90x210x130	90x180x130	90x210x130	155x180x110	155x230x110
Weight (kg)	4.5	5.3	4.5	5.3	3 + 2.5*	3.8 + 2.5*	3.5	4	3.5	4	3.5 + 2.5*	4 + 2.5*
Others	smooth start and change of stirring speed while operation impeller height adjustable chrome-plated stainless steel chuck CE certified and unique serial number for tracing						smooth start and change of stirring speed while operation storage function for timer and speed impeller height adjustable chrome-plated stainless steel chuck CE certified and unique serial number for tracing					
Power supply	AC 230V or AC 120V											

* weight of remote controller

Material	Viscosity (mPas)	Recommended overhead stirrer			
Water	1	HS-30D HS-50A HS-30T	HS-100D HS-120A HS-100T	HT-50DX HT-50AX HT-50T	HT-120DX HT-120AX HT-120T
Milk	3				
Soyabean oil	160				
Varnish	500				
Lacquer	1,000				
Honey	3,000				
Standard viscosity	10,000				
Standard viscosity	15,000				
Ketchup	30,000				
Standard viscosity	50,000				
Mustard	70,000				
Corn syrup	100,000				
Standard viscosity	150,000				
Peanut butter	250,000				

powerful DC motor for various stirring applications (direct-driven or worm-gear)

high-speed or high-torque versions available

digital feedback controller

steady and constant stirring speed

chrome-plated stainless steel chuck to prevent corrosion

anti-trembling system - the impeller is fixed at two points within the body and chuck

adjustable impeller position (height)

motor overload and overheat protection for highest safety and long lifetime

available as set with impeller, plate stand and clamp

many different impellers and plate stands available (see page 120 & 121)



High-speed (HS models)

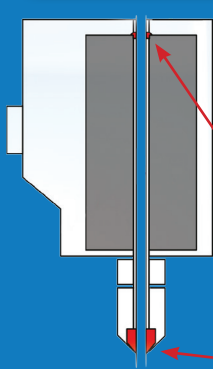

The direct driven motor ensures high-speed at all recommended viscosities (see previous page).

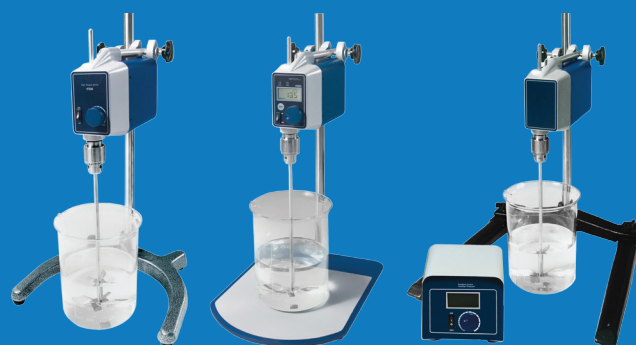

High-torque (HT models)

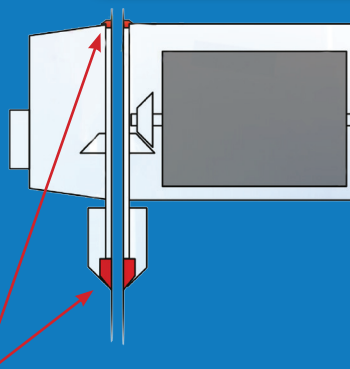

The worm-gear motor ensures high-torque at all recommended viscosities (see previous page).

The impeller is fixed at two points within the body to ensure smooth operation without trembling.

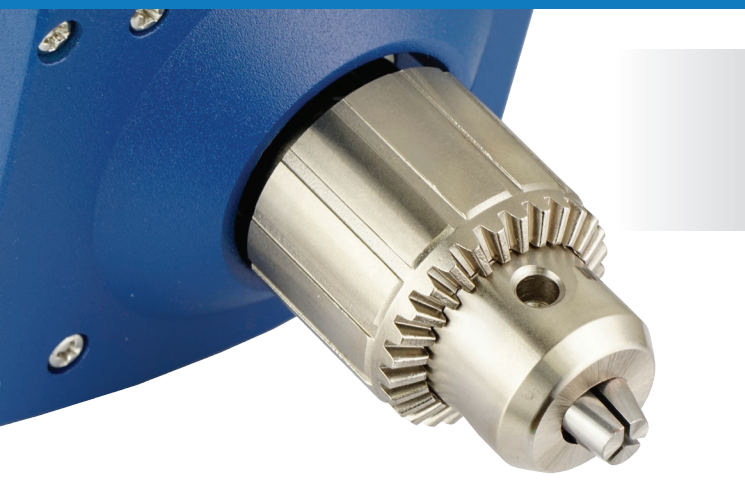

Anti-rust chuck - chrome-plated stainless steel

The anti-rust chuck is chrome-plated to prevent from corrosion by dropping or smoking liquids.

The chuck also fixes the impeller within the body and allows smooth operation without trembling.

Overhead stirrer | high-speed

digital, up to 10 / 20 liter, 10,000 / 50,000 mPas, 200 - 3,000 rpm

200-3,000 rpm
10,000 mPas
50,000 mPas



HS-100D Set

HS-D high-speed digital

Ideal for:

- all mixing applications in the laboratory
- specialized for low- to medium-viscosity materials

Features:

- maximal 10 / 20 liter
- 200 - 3,000 rpm
- maximal viscosity 10,000 / 50,000 mPas
- direct driven motor
- digital LCD display
- smooth start and change of stirring speed while operation
- storage function for timer and speed
- impeller height adjustable
- chrome-plated stainless steel chuck
- CE certified and unique serial number for tracing

Safety mechanism:

- timer 99h 59min with timer-end signal
- error status
- locking mode
- overload protection
- overheat protection
- operation LEDs

Controller:

- **Jog-Shuttle** controller with touch-button

Model	HS-30D	HS-100D
Design	high-speed	
Controller-type	digital, integrated, Jog-Shuttle	
Stirring capacity (H ₂ O)	max. 10 l	max. 20 l
Max. viscosity (mPas)	10,000 mPas	50,000 mPas
Max. torque (N cm) at chuck	85 N cm	145 N cm
Max. impeller shaft	Ø 8 mm	
Speed range	200 - 3,000 rpm	
Timer & alarm	99hr 59min (with continuous run), error status and timer-end	
Controller	digital Feedback Controller with Jog-Shuttle (Turn+Push)	
Display	digital LCD with backlight function	
Permissible temperature & RH %	ambient temperature 0 ~ 40°C, 80% RH	
Safety device	overheat & overload protection	
Dimension & weight	90x145xh180 mm, 4.5 kg	90x145xh180 mm, 5.3 kg
Packaging size	320x300xh180 mm, 5 kg	320x300xh180 mm, 8 kg
Material	ABS & Aluminium	
Power supply	1 Phase AC 120V, 60 Hz or AC 230V, 50/60 Hz	
Order number 230V	Unit: DH.WOS01015 Set: DH.WOS01016	Unit: DH.WOS01025 Set: DH.WOS01026
Order number 120V	Unit: DH.WOS02015 Set: DH.WOS02016	Unit: DH.WOS02025 Set: DH.WOS02026

Set includes: Unit HS-D
Impeller HS-30D: PL010 3-bladed Ø50 mm, HS-100D: PL015 4-bladed Ø70 mm
Clamp CL200
Plate stand HS-30D: ST110 20x35 cm, HS-100D: ST120 30x40 cm

Accessories: Impellers and plate stands on page 120 & 121

Overhead stirrer | high-speed

digital remote controller, up to 10 / 20 liter, 10,000 / 50,000 mPas, 200 - 3,000 rpm

200-3,000 rpm
10,000 mPas
50,000 mPas



HS-100T Set

HS-T high-speed digital

Ideal for:

- all mixing applications in the laboratory
- specialized for low- to medium-viscosity materials
- convenient for applications where remote control is needed

Features:

- maximal 10 / 20 liter
- 200 - 3,000 rpm
- maximal viscosity 10,000 / 50,000 mPas
- direct driven motor
- digital LCD display on remote controller
- smooth start and change of stirring speed while operation
- storage function for timer and speed
- impeller height adjustable
- chrome-plated stainless steel chuck
- CE certified and unique serial number for tracing

Safety mechanism:

- timer 99h 59min with timer-end signal
- error status
- locking mode
- overload protection
- overheat protection
- operation LEDs

Controller:

- **Jog-Shuttle** remote controller with touch-button

Model	HS-30T	HS-100T
Design	high-speed	
Controller-type	digital, remote, Jog-Shuttle	
Stirring capacity (H ₂ O)	max. 10 l	max. 20 l
Max. viscosity (mPas)	10,000 mPas	50,000 mPas
Max. torque (N cm) at chuck	85 N cm	145 N cm
Max. impeller shaft	Ø 8 mm	
Speed range	200 - 3,000 rpm	
Timer & alarm	99hr 59min (with continuous run), error status and timer-end	
Controller	remote digital Feedback Controller with Jog-Shuttle (Turn+Push)	
Display	digital LCD with backlight function	
Permissible temperature & RH %	ambient temperature 0 ~ 40°C, 80% RH	
Safety device	overheat & overload protection	
Dimension & weight	90x100xh180 mm, 3 kg	90x100xh180 mm, 3.8 kg
Packaging size	580x340xh230 mm, 5 kg	580x340xh230 mm, 8 kg
Material	ABS & Aluminium	
Power supply	1 Phase AC 120V, 60 Hz or AC 230V, 50/60 Hz	
Order number 230V	Unit: DH.WOS01035 Set: DH.WOS01036	Unit: DH.WOS01045 Set: DH.WOS01046
Order number 120V	Unit: DH.WOS02035 Set: DH.WOS02036	Unit: DH.WOS02045 Set: DH.WOS02046

Set includes: Unit HS-T
Impeller HS-30T: PL010 3-bladed Ø50 mm, HS-100T: PL015 4-bladed Ø70 mm
Clamp CL200
Plate stand HS-30T: ST110 20x35 cm, HS-100T: ST120 30x40 cm

Accessories: Impellers and plate stands on page 120 & 121

Overhead stirrer | high-speed

analog, up to 10 / 20 liter, 10,000 / 50,000 mPas, 0 - 3,000 rpm

200-3,000 rpm
10,000 mPas
50,000 mPas



HS-50A Set

HS-A high-speed analog

Ideal for:

- all mixing applications in the laboratory
- specialized for low- to medium-viscosity materials

Features:

- maximal 10 / 20 liter
- up to 3,000 rpm
- maximal viscosity 10,000 / 50,000 mPas
- direct driven motor
- smooth start and change of stirring speed while operation
- impeller height adjustable
- chrome-plated stainless steel chuck
- CE certified and unique serial number for tracing

Safety mechanism:

- overheat protection
- operation LED

Controller:

- **Analog phase** controller with control knob

Model	HS-50A	HS-120A
Design	high-speed	
Controller-type	analog, integrated, phase controller	
Stirring capacity (H ₂ O)	max. 10 l	max. 20 l
Max. viscosity (mPas)	10,000 mPas	50,000 mPas
Max. torque (N cm) at chuck	85 N cm	145 N cm
Max. impeller shaft	Ø 8 mm	
Speed range	up to 3,000 rpm	
Controller	analog phase controller with control knob	
Permissible temperature & RH %	ambient temperature 0 ~ 40°C, 80% RH	
Safety device	overheat protection	
Dimension & weight	90x145x180 mm, 4.5 kg	90x145x180 mm, 5.3 kg
Packaging size	320x300x180 mm, 5 kg	320x300x180 mm, 8 kg
Material	ABS & Aluminium	
Power supply	1 Phase AC 120V, 60 Hz or AC 230V, 50/60 Hz	
Order number 230V	Unit: DH.WOS01210 Set: DH.WOS01211	Unit: DH.WOS01215 Set: DH.WOS01216
Order number 120V	Unit: DH.WOS02210 Set: DH.WOS02211	Unit: DH.WOS02215 Set: DH.WOS02216

Set includes: Unit HS-A
Impeller HS-50A: PL010 3-bladed Ø50 mm, HS-120A: PL015 4-bladed Ø70 mm
Clamp CL200
Plate stand KA1177 34x29 cm

Accessories: Impellers and plate stands on page 120 & 121

Overhead stirrer | high-torque

digital, up to 40 / 60 liter, 100,000 / 150,000 mPas, 50 - 1,000 rpm

50-1,000 rpm
100,000 mPas
150,000 mPas



HT-50DX Set



HT-DX high-torque digital

Ideal for:

- all mixing applications in the laboratory
- specialized for light watery solutions up to high-viscosity fluids

Features:

- maximal 40 / 60 liter
- 50 - 1,000 rpm
- maximal viscosity 100,000 / 150,000 mPas
- worm-gear motor (ratio 3.5:1)
- digital LCD display
- smooth start and change of stirring speed while operation
- storage function for timer and speed
- impeller height adjustable
- chrome-plated stainless steel chuck
- CE certified and unique serial number for tracing

Safety mechanism:

- timer 99h 59min with timer-end signal
- error status
- locking mode
- overload protection
- overheat protection
- operation LEDs

Controller:

- **Jog-Shuttle** controller with touch-button

Model	HT-50DX	HT-120DX
Design	high-torque	
Controller-type	digital, integrated, Jog-Shuttle	
Stirring capacity (H ₂ O)	max. 40 l	max. 60 l
Max. viscosity (mPas)	100,000 mPas	150,000 mPas
Max. torque (N cm) at chuck	300 N cm	500 N cm
Max. impeller shaft	Ø 10 mm	
Speed range	50 - 1,000 rpm	
Timer & alarm	99hr 59min (with continuous run), error status and timer-end	
Controller	digital Feedback Controller with Jog-Shuttle (Turn+Push)	
Display	digital LCD with backlight function	
Permissible temperature & RH %	ambient temperature 0 ~ 40°C, 80% RH	
Safety device	overheat & overload protection	
Dimension & weight	90x180x130 mm, 3.5 kg	90x210x130 mm, 4 kg
Packaging size	320x300x180 mm, 5 kg	320x300x180 mm, 8 kg
Material	ABS & Aluminium	
Power supply	1 Phase AC 120V, 60 Hz or AC 230V, 50/60 Hz	
Order number 230V	Unit: DH.WOS01051 Set: DH.WOS01052	Unit: DH.WOS01071 Set: DH.WOS01072
Order number 120V	Unit: DH.WOS02051 Set: DH.WOS02052	Unit: DH.WOS02071 Set: DH.WOS02072

Set includes: Unit HT-DX
Impeller PL020 4-bladed Ø90 mm
Clamp CL200
Plate stand HT-50DX: ST120 30x40 cm, HT-120DX: ST200 39x up to 75 cm

Accessories: Impellers and plate stands on page 120 & 121

Overhead stirrer | high-torque

digital remote controller, up to 40 / 60 liter, 100,000 / 150,000 mPas, 50 - 1,000 rpm

50-1,000 rpm
100,000 mPas
150,000 mPas



HT-50T Set



HT-T high-torque digital

Ideal for:

- all mixing applications in the laboratory
- specialized for light watery solutions up to high-viscosity fluids
- convenient for applications where remote control is needed

Features:

- maximal 40 / 60 liter
- 50 - 1,000 rpm
- maximal viscosity 100,000 / 150,000 mPas
- worm-gear motor (ratio 3.5:1)
- digital LCD display on remote controller
- smooth start and change of stirring speed while operation
- storage function for timer and speed
- impeller height adjustable
- chrome-plated stainless steel chuck
- CE certified and unique serial number for tracing

Safety mechanism:

- timer 99h 59min with timer-end signal
- error status
- locking mode
- overload protection
- overheat protection
- operation LEDs

Controller:

- **Jog-Shuttle** remote controller with touch-button

Model	HT-50T	HT-120T
Design	high-torque	
Controller-type	digital, remote, Jog-Shuttle	
Stirring capacity (H ₂ O)	max. 40 l	max. 60 l
Max. viscosity (mPas)	100,000 mPas	150,000 mPas
Max. torque (N cm) at chuck	300 N cm	500 N cm
Max. impeller shaft	Ø 10 mm	
Speed range	50 - 1,000 rpm	
Timer & alarm	99hr 59min (with continuous run), error status and timer-end	
Controller	remote digital feedback controller with Jog-Shuttle (Turn+Push)	
Display	digital LCD with backlight function	
Permissible temperature & RH %	ambient temperature 0 ~ 40°C, 80% RH	
Safety device	overheat & overload protection	
Dimension & weight	155x180xh110 mm, 3.5 kg	155x230xh110 mm, 4 kg
Packaging size	580x340xh230 mm, 5 kg	580x340xh230 mm, 8 kg
Material	ABS & Aluminium	
Power supply	1 Phase AC 120V, 60 Hz or AC 230V, 50/60 Hz	
Order number 230V	Unit: DH.WOS01065 Set: DH.WOS01066	Unit: DH.WOS01075 Set: DH.WOS01076
Order number 120V	Unit: DH.WOS02065 Set: DH.WOS02066	Unit: DH.WOS02075 Set: DH.WOS02076

Set includes: Unit HT-T
Impeller PL020 4-bladed Ø90 mm
Clamp CL200
Plate stand HT-50T: ST120 30x40 cm, HT-120T: ST200 39x up to 75 cm

Accessories: Impellers and plate stands on page 120 & 121

Overhead stirrer | high-torque

analog, up to 40 / 60 liter, 100,000 / 150,000 mPas, up to 1,000 rpm

up to 1.000 rpm

100.000 mPas

150.000 mPas



HT-50AX Set



HT-AX high-torque analog

Ideal for:

- all mixing applications in the laboratory
- specialized for light watery solutions up to high-viscosity fluids

Features:

- maximal 40 / 60 liter
- up to 1,000 rpm
- maximal viscosity 100,000 / 150,000 mPas
- worm-gear motor (ratio 3.5:1)
- smooth start and change of stirring speed while operation
- impeller height adjustable
- chrome-plated stainless steel chuck
- CE certified and unique serial number for tracing

Safety mechanism:

- overheat protection
- operation LED

Controller:

- **Analog phase** controller with control knob

Model	HT-50AX	HT-120AX
Design	high-torque	
Controller-type	analog, integrated, phase controller	
Stirring capacity (H₂O)	max. 40 l	max. 60 l
Max. viscosity (mPas)	100,000 mPas	150,000 mPas
Max. torque (N cm) at chuck	300 N cm	500 N cm
Max. impeller shaft	Ø 10 mm	
Speed range	up to 1,000 rpm	
Controller	analog phase controller with control knob	
Permissible temperature & RH %	ambient temperature 0 ~ 40°C, 80% RH	
Safety device	overheat protection	
Dimension & weight	90x180xh130 mm, 3.5 kg	90x210xh130 mm, 4 kg
Packaging size	320x300xh180 mm, 5 kg	320x300xh180 mm, 8 kg
Material	ABS & Aluminium	
Power supply	1 Phase AC 120V, 60 Hz or AC 230V, 50/60 Hz	
Order number 230V	Unit: DH.WOS01251 Set: DH.WOS01252	Unit: DH.WOS01271 Set: DH.WOS01272
Order number 120V	Unit: DH.WOS02251 Set: DH.WOS02252	Unit: DH.WOS02271 Set: DH.WOS02272

Set includes: Unit HT-AX
 Impeller PL020 4-bladed Ø90 mm
 Clamp CL200
 Plate stand KA1177 34x29 cm

Accessories: Impellers and plate stands on page 120 & 121

Overhead stirrer | Jar tester

Accessories: Stirring impellers and plate stands

Stirring impellers for high-speed and high-torque overhead stirrer - Ø8mm

- universal-types and wide-range-types
- shaft made of stainless steel, blades made of stainless steel or PTFE-coated
- excellent resistance to acids, chemicals, corrosion and high temperature

Type	Blades	Rod	Article	Order number
Propeller-type	3-bladed Ø50 x h15mm	Ø8 x L500 mm	PL010	DH.WOS501010
Propeller-type	3-bladed Ø60 x h15 mm	Ø8 x L500 mm	PL011	DH.WOS501011
Propeller-type	3-bladed Ø80 x h20 mm	Ø8 x L650 mm	PL012	DH.WOS501012
Propeller-type	3-bladed Ø100 x h24 mm	Ø8 x L650 mm	PL013	DH.WOS501013
Propeller-type	4-bladed Ø50 x h20 mm	Ø8 x L500 mm	PL014	DH.WOS501014
Propeller-type	4-bladed Ø70 x h25 mm	Ø8 x L500 mm	PL015	DH.WOS501015
Propeller-type	4-bladed Ø90 x h35 mm	Ø8 x L650 mm	PL016	DH.WOS501016
Propeller-type	4-bladed Ø110 x h35 mm	Ø8 x L650 mm	PL017	DH.WOS501017
Diamond-type	4-bladed Ø70 x h20 mm	Ø8 x L500 mm	PL019	DH.WOS501019
Diamond-type	4-bladed Ø90 x h25 mm	Ø8 x L500 mm	PL020	DH.WOS501020
Diamond-type	4-bladed Ø100 x h25 mm	Ø8 x L650 mm	PL021	DH.WOS501021
Centrifugal-type PTFE-coated	2-bladed Ø50 x h14 mm	Ø8 x L500 mm	PL029	DH.WOS501029
Centrifugal-type PTFE-coated	2-bladed Ø70 x h17 mm	Ø8 x L500 mm	PL030	DH.WOS501030
Centrifugal-type PTFE-coated	2-bladed Ø100 x h24 mm	Ø8 x L650 mm	PL031	DH.WOS501031
Anchor-type	2-bladed Ø70 x h14 mm	Ø8 x L500 mm	PL035	DH.WOS501035
Anchor-type	2-bladed Ø90 x h16 mm	Ø8 x L650 mm	PL036	DH.WOS501036



Propeller-type 3-bladed

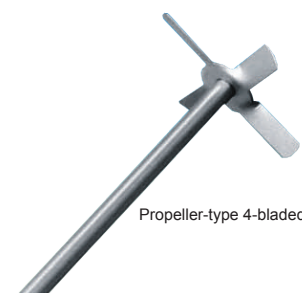

Propeller-type 4-bladed

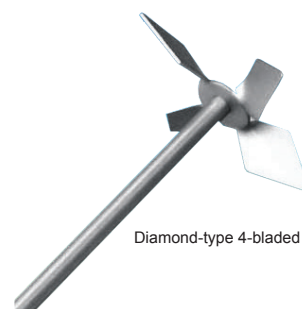

Diamond-type 4-bladed

Stirring impellers for high-torque overhead stirrer - Ø10mm

- universal-types and wide-range-types
- shaft made of stainless steel, blades made of stainless steel or PTFE-coated
- excellent resistance to acids, chemicals, corrosion and high temperatures

Type	Blades	Rod	Article	Order number
Propeller-type	3-bladed Ø60 x h15 mm	Ø10 x L500 mm	PL111	DH.WOS501111
Propeller-type	3-bladed Ø80 x h20 mm	Ø10 x L650 mm	PL112	DH.WOS501112
Propeller-type	3-bladed Ø100 x h24 mm	Ø10 x L800 mm	PL113	DH.WOS501113
Propeller-type	4-bladed Ø90 x h35 mm	Ø10 x L650 mm	PL116	DH.WOS501116
Propeller-type	4-bladed Ø110 x h40 mm	Ø10 x L800 mm	PL117	DH.WOS501117
Propeller-type	4-bladed Ø110 x h40 mm	Ø10 x L1000 mm	PL118	DH.WOS501118
Diamond-type	4-bladed Ø110 x h25 mm	Ø10 x L650 mm	PL121	DH.WOS501121
Centrifugal-type PTFE-coated	2-bladed Ø100 x h24 mm	Ø10 x L650 mm	PL130	DH.WOS501130
Anchor-type	2-bladed Ø90 x h16 mm	Ø10 x L650 mm	PL135	DH.WOS501135
Anchor-type	2-bladed Ø140 x h25 mm	Ø10 x L800 mm	PL136	DH.WOS501136
Anchor-type	2-bladed Ø160 x h30 mm	Ø10 x L1000 mm	PL137	DH.WOS501137

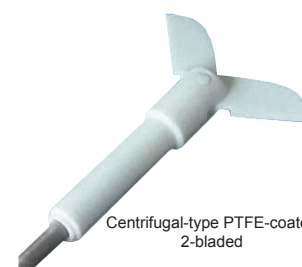

Centrifugal-type PTFE-coated 2-bladed



Anchor-type 2-bladed

Overhead stirrer | Jar tester

Accessories: Stirring impellers and plate stands

Plate stand with stainless steel rod

- suitable for all overhead stirrer and homogenizer
- plate with silicone rubber pad (ST110, ST120) or heavy duty safety stand (ST200, KA1177)

Type	Rod	Plate	Article	Order number
Silicone rubber pad	Ø16xh800 mm with thread	20 x 35 cm	ST110	DH.WOS501510
Silicone rubber pad	Ø23xh1000 mm with thread	30 x 40 cm	ST120	DH.WOS501515
Heavy duty safety stand	Ø23xh1200 mm	39 x up to 75 cm adjustable	ST200	DH.WOS501520
Heavy duty safety stand	Ø23xh800 mm	34 x 29 cm	KA1177	DH.WOS1177

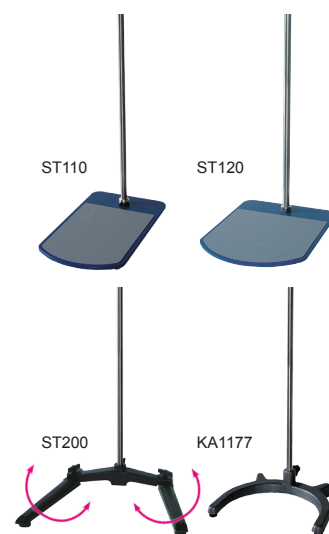

Universal jumbo clamp holder for plate stand

- suitable for all overhead stirrer and homogenizer plate stands

Type	Material	Mounting	Article	Order number
Jumbo clamp holder	cast aluminium	for Ø23 mm rod	CL200	DH.WOS502020

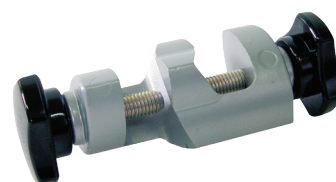

Rods for plate stands

- with and without thread
- made of stainless steel

Type	Rod	Article	Order number
without thread	Ø16 x h800 mm	RD501	DH.WOS502001
without thread	Ø16 x h1000 mm	RD502	DH.WOS502002
without thread	Ø16 x h1200 mm	RD503	DH.WOS502003
without thread	Ø23 x h800 mm	RD531	DH.WOS502031
without thread	Ø23 x 1200 mm	RD533	DH.WOS502033
with thread	Ø16 x h800 mm	RD511	DH.WOS502011
with thread	Ø16 x h1000 mm	RD512	DH.WOS502012
with thread	Ø16 x h1200 mm	RD513	DH.WOS502013
with thread	Ø23 x h800 mm	RD521	DH.WOS502021
with thread	Ø23 x h1000 mm	RD522	DH.WOS502022
with thread	Ø23 x h1200 mm	RD523	DH.WOS502023



Flexible couplings for safety stirring

Type	for shafts	Article	Order number
basic rubber / metal	Ø6-8 mm	W1-COR-6	1 445 000
basic rubber / metal	Ø8-10 mm	W1-COR-8	1 445 010
PTFE / Polyamid	Ø8mm		1 445 500
PTFE / Polyamid	Ø10mm		1 445 510
PTFE / Polyamid	Ø14mm		1 445 514
PTFE / Polyamid	Ø16mm		1 445 516
heavy-duty stainless steel	Ø6-8 mm	PKK-10	KG.40477
heavy-duty stainless steel	Ø12-14 mm	PKK-16	KG.40478



Homogenizer

digital remote controller, 2,000 - 27,000 rpm, up to 2,500 ml

2,000-27,000 rpm
up to 2,500 ml



HG-15D Set



HG-15D digital, 2,000-27,000rpm

Ideal for:

- all dispersing and homogenizing applications
- designed for liquid and tissue samples

Features:

- 2,000 - 27,000 rpm
- working range 1 - 2,500 ml
- digital LCD display on remote controller
- timer from 10sec up to 15min
- CE certified and unique serial number for tracing

Safety mechanism:

- timer-end alarm
- overload protection
- overheat protection

Controller:

- **Jog-Shuttle** remote controller with touch-button

Model	HG-15D
Speed range & resolution	2,000 - 27,000 rpm, 10 rpm
Working range	1 - 2,500 ml
Motor rating	input: 300W, output: 160W
Timer & alarm	10sec - 15min, timer-end alarm
Display	digital LCD with backlight function
Controller	digital Feedback Controller (remote)
Safety device	overload & overheat protection
Material	aluminium die-casting and ABS unit
Permissible temperature & RH %	ambient temperature +5 ~ 50°C, 85% RH
Extension arm size	Ø12.7 x L250 mm
Dimension & weight	60x75xh215 mm, 2.5 kg
Packaging size	580x340xh230 mm, 6 kg
Power supply	1 Phase AC 120V, 60 Hz or AC 230V, 50/60 Hz
Order number 230V	Unit: DH.WHG02018 Set A: DH.WHG02019 Set B: DH.WHG02020
Order number 120V	Unit: DH.WHG01018 Set A: DH.WHG01019 Set B: DH.WHG01020

Set A includes:	Unit	HG-15D
	Dispersing tool	HT1018 rotor Ø12.5 mm, stator Ø18 mm, for 10-1,000 ml
	Clamp	CL200 for stirrer and homogenizer
	Plate stand with rod	ST110 plate 20x35 cm, rod Ø16 x h800 mm
Set B includes:	Unit	HG-15D
	Dispersing tool	HT1025 rotor Ø20 mm, stator Ø25 mm, for 50-2,500 ml
	Clamp	CL200 for stirrer and homogenizer
	Plate stand with rod	ST110 plate 20x35 cm, rod Ø16 x h800 mm

Accessories: Dispersing tools, tissue grinder, pestles and plate stands on page 125

Homogenizer

analog, up to 27,000 rpm, up to 2,500 ml

up to 27,000 rpm
up to 2,500 ml



HG-15A Set

HG-15A analog, up to 27,000rpm

Ideal for:

- all dispersing and homogenizing applications
- designed for liquid and tissue samples

Features:

- up to 27,000 rpm
- working range 1 - 2,500 ml
- CE certified and unique serial number for tracing

Safety mechanism:

- overheat protection

Controller:

- analog stepless controller with touch-button

Model	HG-15A
Speed range & resolution	up to 27,000 rpm, stepless
Working range	1 - 2,500 ml
Motor rating	input: 300W, output: 160W
Controller	analog phase controller
Safety device	overheat protection
Material	aluminium die-casting and ABS unit
Permissible temperature & RH %	ambient temperature +5 ~ 50°C, 85% RH
Extension arm size	Ø12.7 x L250 mm
Dimension & weight	60x75xh215 mm, 2.5 kg
Packaging size	320x300xh190 mm, 5 kg
Power supply	1 Phase AC 120V, 60 Hz or AC 230V, 50/60 Hz
Order number 230V	Unit: DH.WHG02015 Set A: DH.WHG02016 Set B: DH.WHG02017
Order number 120V	Unit: DH.WHG01015 Set A: DH.WHG01016 Set B: DH.WHG01017

Set A includes:	Unit	HG-15A
	Dispersing tool	HT1018 rotor Ø12.5 mm, stator Ø18 mm, for 10-1,000 ml
	Clamp	CL200 for stirrer and homogenizer
	Plate stand with rod	ST110 plate 20x35 cm, rod Ø16 x h800 mm
Set B includes:	Unit	HG-15A
	Dispersing tool	HT1025 rotor Ø20 mm, stator Ø25 mm, for 50-2,500 ml
	Clamp	CL200 for stirrer and homogenizer
	Plate stand with rod	ST110 plate 20x35 cm, rod Ø16 x h800 mm

Accessories: Dispersing tools, tissue grinder, pestles and plate stands on page 125

Homogenizer

analog, 200 - 5,000 rpm, up to 10,000 ml

200 - 5,000 rpm
up to 10,000 ml



HS-30E Set
(tissue grinder not included)



HS-30E analog, 200-5,000rpm

Ideal for:

- all dispersing and homogenizing applications
- designed for tissue grinders

Features:

- 200 - 5,000 rpm
- working range up to 10,000 ml
- CE certified and unique serial number for tracing

Safety mechanism:

- overheat protection

Controller:

- analog stepless controller with touch-button

Model	HS-30E
Speed range & resolution	200 - 5,000 rpm, 85 N cm
Working range	up to 10,000 ml
Motor rating	input: 83W, output: 75W, 1/10 HP
Controller	analog phase controller
Safety device	overheat protection
Material	aluminium die-casting and ABS unit
Permissible temperature & RH %	ambient temperature +5 ~ 50°C, 85% RH
Dimension & weight	90x145xh180 mm, 3.5 kg
Packaging size	320x300xh190 mm, 5 kg
Power supply	1 Phase AC 120V, 60 Hz or AC 230V, 50/60 Hz
Order number 230V	Unit: DH.WOS01010 Set: DH.WOS01011
Order number 120V	Unit: DH.WOS02010 Set: DH.WOS02011

Set includes: Unit HS-30E
Clamp CL200 for stirrer and homogenizer
Plate stand with rod ST110 plate 20x35 cm, rod Ø16 x h800 mm
NOTE: No tissue grinder included!

Accessories: Dispersing tools, tissue grinder, pestles and plate stands on page 125

Homogenizer

Accessories: Dispersing tools, tissue grinder and plate stands

Dispersing tools for homogenizer

• stator and rotor made of stainless steel

Model	HT1008	HT1010	HT1018	HT1025
Working range	1 - 50 ml	1 - 100 ml	10 - 1,000 ml	50 - 2,500 ml
Stator	Ø8 mm	Ø10 mm	Ø18 mm	Ø25 mm
Rotor	Ø6 mm	Ø7.96 mm	Ø12.8 mm	Ø20 mm
Gap stator <-> rotor	0.25 mm	0.2 mm	0.25 mm	0.35 mm
Maximal speed	27,000 rpm		20,000 rpm	15,000 rpm
Immersion depth min.	35 mm		60 mm	
Immersion depth max.	70 mm		130 mm	
Shaft length	138 mm		225 mm	
Bearing material	PTFE			
Suitable for solvent	Yes			
Maximal temperature	180°C			
Sterilization method	all methods			
Suspension and emulsions	suspension: 10-50µm, emulsion: 1-10µm			
Order number	DH.WHG02108	DH.WHG02110	DH.WHG02118	DH.WHG02125

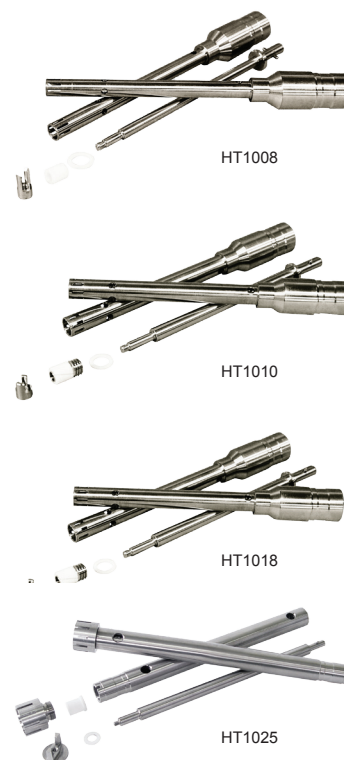

Tissue grinders and pestles for homogenizers

Material	for capacity	working Ø	height	Order number
Tissue grinder borosilicate glass clearance 0.15 - 0.25 mm pestle shaft 6.5 mm	2 ml	8 mm	120 mm	5 553 800
	5 ml	12 mm	135 mm	5 553 801
	10 ml	15 mm	150 mm	5 553 802
	15 ml	16 mm	155 mm	5 553 803
	30 ml	25 mm	175 mm	5 553 804
	50 ml	32 mm	195 mm	5 553 805
Pestle PTFE head, serrated stainless steel shaft	2 ml		230 mm	5 553 850
	5 ml		235 mm	5 553 851
	10 ml		270 mm	5 553 852
	15 ml		270 mm	5 553 853
	30 ml		270 mm	5 553 854
	50 ml		270 mm	5 553 855



Plate stand with stainless steel rod

• plate with silicone rubber pad (ST110, ST120) or heavy duty safety stand (ST200, KA1177)

Type	Rod (included)	Plate	Article	Order number
Silicone rubber pad	Ø16xh800 mm with thread	20 x 35 cm	ST110	DH.WOS501510
Silicone rubber pad	Ø23xh1,000 mm with thread	30 x 40 cm	ST120	DH.WOS501515
Heavy duty safety stand	Ø23xh1,200 mm	39 x up to 75 cm adjustable	ST200	DH.WOS501520
Heavy duty safety stand	Ø23xh800 mm	34 x 29 cm	KA1177	DH.WOS1177



Universal jumbo clamp holder for plate stand

• suitable for all overhead stirrer and homogenizer plate stands

Type	Material	Mounting	Article	Order number
Jumbo clamp holder	cast aluminium	for Ø23 mm rod	CL200	DH.WOS502020

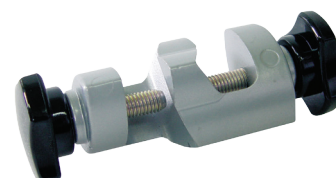

Vortex mixer

up to 3,300 rpm, orbital shaking motion, multiple heads available

VM-10
with platform head



VM-10 orbital motion

Ideal for:

- mixing solutions in test tubes or small flasks with circular, oscillating movement

Features:

- 0 - 3,300 rpm
- orbital motion
- inclusive platform head Ø76 mm and pop-off cup head
- 3-position power switch for continuous run or „touch-on“
- stepless adjustable speed by turning the dial-knob
- tough metal housing and reliable suction cups ensure stable motion, low noise and safe working
- various shapes, sizes and materials of the head allow mixing of almost all common tubes and containers
- CE certified and unique serial number for tracing

Controller:

- **analog phase** controller
- 3-position switch for start, stop and „touch-on“
- dial-knob for stepless speed setting

Model	VM-10
Design	vortex mixer
Speed range	0-3,300 rpm
Shaking motion	orbital
Controller	analog phase controller
Material	aluminium die-casting with powder-coating
Head	included pop-off cup head and Ø76 mm platform
Dimension & weight	160x128x145 mm, 3 kg
Packaging size	260x200x220 mm, 4 kg
Power supply	1 Phase AC 120V, 60 Hz or AC 230V, 50/60 Hz
Order number 230V	DH.WVM00010
Order number 120V	DH.WVM00020

Scope of supply:

- Vortex mixer VM-10
- platform head PM110 Ø76mm
- pop-off cup head PM210
- removing tool for heads

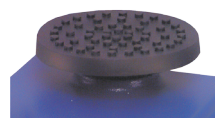

Platform head PM110



Removing tool



Pop-off cup head PM210

Accessories:

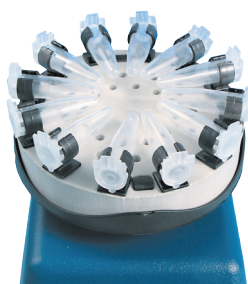

Microtube platform head for 0.5 - 2.0 ml

Article	Order number
PM310	DH.WVM00310

NEW

Vortex mixer

up to 3,300 rpm, orbital shaking motion, multiple heads available

VM-30 orbital motion

Ideal for:

- mixing solutions in test tubes or small flasks with circular movement

Features:

- 0 - 3,300 rpm
- ergonomic design with a stable, low profile, robust die cast construction
- exceptional stability on the bench thanks to the combination of weight and non-slip feet
- powerful motor for efficient mixing
- variable speed control for gentle to vigorous mixing
- electronic control for constant speed even during changes in load
- various shapes, sizes and materials of the head allow mixing of almost all common tubes and containers
- CE certified and unique serial number for tracing

Controller:

- **analog phase** controller
- continuous run and „Touch-on“-function



VM-30 with platform head

Model	VM-30
Design	vortex mixer
Speed range	0-3,300 rpm
Shaking motion	orbital, 4.0 mm
Controller	analog phase controller
Material	aluminium die-casting with powder-coating
Head	included pop-off cup head and Ø76 mm platform
Max. load	0.5 kg
Dimension & weight	140 x 190 x 123 mm, 3 kg
Packaging size	175 x 255 x 215 mm, 3 kg
Power consumption	30 W
Power supply	1 Phase AC 120V, 60 Hz or AC 230V, 50/60 Hz
Order number 230V	DH.WVM00031
Order number 120V	DH.WVM00033

Scope of supply:

- Vortex mixer VM-30
- platform head PM110 Ø76mm
- pop-off cup head PM210
- removing tool for heads

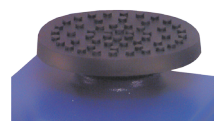

Platform head PM110



Removing tool



Pop-off cup head PM210

Optional accessories:



Microtube platform head for 0.5 - 2.0 ml

Article	Order number
PM310	DH.WVM00310

Shaker

orbital motion, 10 - 300 rpm, programmable



SHO orbital motion



SHO-1D with optional rubber mat platform



SHO-2D with optional universal platform and flask holder

Ideal for:

- culturing cells to hybridization, staining and destaining gels, and combinatorial chemistry
- hybridization, washing blots, culturing microbes

Features:

- 10 - 300 rpm
- 230x230 mm or 350x350 mm
- digital LCD display
- smooth start and change of shaking speed while operation
- minimum noise
- timer for 0-99 hours
- multiple platforms and flask holder available
- brushless DC motor
- CE certified and unique serial number for tracing

Safety mechanism:

- timer 99h 59min with timer-end signal
- operation LEDs
- overload protection
- locking mode

Controller:

- programmable **Jog-Shuttle** controller with touch-button

Model	SHO-1D	SHO-2D
Design	shaker orbital motion	
Platform	230x230 mm	350x350 mm
Speed range	10-300 rpm	
Max. load	8 kg	10 kg
Amplitude	10 mm	20 mm
Programs	6 programs, 10 steps	
Permissible temperature & RH %	ambient temp. +5 ~ 50°C, 85% RH	
Timer & alarm	99hr 59min, error status timer-end	
Display	digital LCD with backlight function	
Controller	digital feedback controller (Jog-Shuttle)	
Safety circuit	overload protection	
Dimension & weight	250x330xh150 mm, 14 kg	400x480xh160 mm, 20 kg
Packaging size	450x350xh250 mm, 18 kg	580x500xh250 mm, 23 kg
Power supply	1 Phase AC 120V, 60 Hz or AC 230V, 50/60 Hz	
Order number 230V	DH.WSO04010	DH.WSO04012
Order number 120V	DH.WSO05010	DH.WSO05012

Please note: no platform included - please order separately!

maximal amount of flask holder depends on platform and flask holder size - more information on 132

OB-2/RP-2

Ideal for:

- culturing cells to hybridization, staining and destaining gels, and combinatorial chemistry
- hybridization, washing blots, culturing microbes

Features:

- compact design, fits in incubators and on laboratory benches
- built-in timer, continuous run or timer mode (99 h 59 min)
- digital speed control from 10 to 300 rpm
- each device can be used with both platform sizes (251 x 251 mm/ 346 x 346 mm)
- various platforms and flask holders available
- large LCD display views operation mode, speed and timer adjustment, clearly laid-out control panel for easy operation
- constant speed independent of load
- brushless DC motor
- CE certified and unique serial number for tracing

Safety mechanism:

- overload protection
- over speed control and protection

Controller:

- **PID-speed control** with gentle start (reduces risk of spills) and gentle slow down
- digital feedback controller (Jog-Dial)

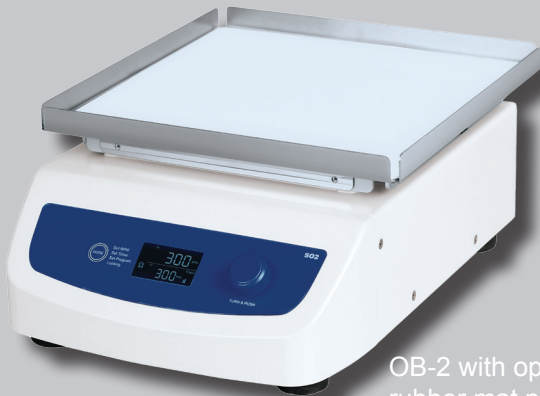

OB-2 with optional rubber mat platform



RP-2 with optional universal platform and flask holder

Modell		OB-2	RP-2
Design		orbital motion	reciprocating motion
Platform		255 x 255 mm	
Speed range		10-300 rpm	
Max. load & amplitude		10 kg, 10 mm	
Programs		6 programs, 10 steps	
Permissible temperature & RH %		ambient +5 - 50°C, 85% RH	
Max. capacity of flask holders	for 100 ml	251 x 251 mm universal platform: 9 flask holder 346 x 346 mm universal platform: 20 flask holder	
	for 250 ml	251 x 251 mm universal platform: 7 flask holder 346 x 346 mm universal platform: 15 flask holder	
	for 500 ml	251 x 251 mm universal platform: 5 flask holder 346 x 346 mm universal platform: 9 flask holder	
	for 1000 ml	251 x 251 mm universal platform: 4 flask holder 346 x 346 mm universal platform: 6 flask holder	
Timer & alarm		99hr 59 min, error status, timer-end	
Display		large digital LCD display with backlight function	
Controller		digital feedback controller (Jog-Dial)	
Dimension & weight, Packaging size		376 x 375 x 138 mm, 13 kg, 345 x 420 x 205 mm, 13.5 kg	
Power consumption		45 W	
Power supply		1 Phase AC 120V, 60 Hz or AC 230V, 50/60 Hz	
Order number 230V		DH.WSO00300	DH.WSR00300
Order number 120V		DH.WSO00301	DH.WSR00301

Please note: no platform included - please order separately!

Accessories: Universal platform, rubber mat platform, platform for flasks, flask holder and spring rack on page 132

Shaker

reciprocating motion, 10 - 300 rpm, programmable

SHR reciprocating motion



Ideal for:

- culturing cells to hybridization, staining and destaining gels, and combinatorial chemistry
- hybridization, washing blots, culturing microbes

Features:

- 10 - 300 rpm
- 230x230 mm or 350x350 mm
- digital LCD display
- smooth start and change of shaking speed while operation
- minimum noise
- timer for 0-99 hours
- multiple platforms and flask holder available
- brushless DC motor
- CE certified and unique serial number for tracing

Safety mechanism:

- timer 99h 59min with timer-end signal
- operation LEDs
- overload protection
- locking mode

Controller:

- programmable **Jog-Shuttle** controller with touch-button



SHR-1D with optional rubber mat platform



SHR-2D with optional universal platform and flask holder

Model	SHR-1D	SHR-2D
Design	shaker reciprocating motion	
Platform	230x230 mm	350x350 mm
Speed range	10-300 rpm	
Max. load	8 kg	10 kg
Amplitude	10 mm	20 mm
Programs	6 programs, 10 steps	
Permissible temperature & RH %	ambient temp. +5 ~ 50°C, 85% RH	
Timer & alarm	99hr 59min, error status timer-end	
Display	digital LCD with backlight function	
Controller	digital feedback controller (Jog-Shuttle)	
Safety circuit	overload protection	
Dimension & weight	250x330xh150 mm, 14 kg	400x480xh160 mm, 20 kg
Packaging size	450x350xh250 mm, 18 kg	580x500xh250 mm, 23 kg
Power supply	1 Phase AC 120V, 60 Hz or AC 230V, 50/60 Hz	
Order number 230V	DH.WSR04020	DH.WSR04022
Order number 120V	DH.WSR05020	DH.WSR05022

please note: no platform included - please order separately

maximal amount of flask holder depends on platform and flask holder size - more information on 132

Accessories: Universal platform, rubber mat platform, platform for flasks, flask holder and spring rack on page 132

Tube mix rotor

tumbling mixer or compact multi-function mixer / -shaker, with timer

NEW

MixR-40 Rocking & rolling motion

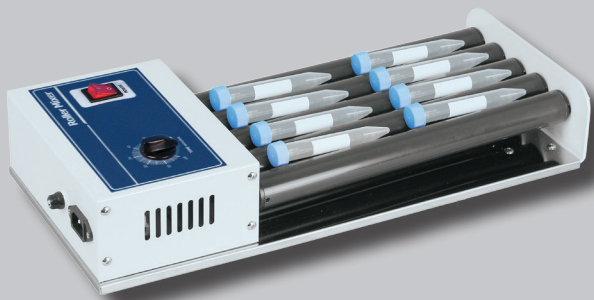

Ideal for:

- mixing blood samples, viscous substances and liquid-solid suspensions
- use in a variety of applications, prevention of blood coagulation and immune precipitation, etc.
- use in cold lab chambers and incubators

Features:

- rocking and rolling motion for complete sample mixing
- with timer, AC synchronous motor with minimal noise, stable mixing motion

Safety mechanism:

- overheat protection for long operations

Model	MixR-40
No. of mixing rollers	5
Mixing roller size & material	Ø32 x 325 mm, PVC
Mixing speed	40 rpm
Capacity	8 x 15 ml or 8 x 50 ml test tubes
Motor	AC synchronous motor, 12W
Timer	0 - 60 Min. analog timer, continuous run
Material (Body)	powder-coated steel
Dimension & weight	490 x 220 x 100 mm, 3 kg
Power supply	AC 230V, 50/60 Hz
Order number	DH.MixR1040

NEW

MixM-100 compact multi-function mixer /-rocker



Ideal for:

- hematology, chemistry, research and bacteriology laboratories

Features:

- smoothly rocking motion
- smooth, steady, quiet and continuous operation
- easy to load and to unload test tubes without turning the mixer off
- rubber cushion preventing the test tubes from slipping

Model	MixM-100
Platform size	300 x 115 mm
Capacity	3 x Ø100 mm dishes or 30 x 1.5 ml microtubes or 15 x 15 ml test tubes or 8 x 50 ml test tubes
Speed	24 rpm at 60 Hz / 20 rpm at 50 Hz
Dimension & net weight	350 x 140 x 110 mm, 1.5 kg
Gross weight	2.0 kg
Order number 230V	DH.MixM0100
Order number 120V	DH.MixM0101

Shaker

Accessories: Platforms, spring rack and flask holder

Platforms

- suitable for Shaker SHO and SHR
- available in different types

Type	For device...	Plate	Article	Order number
Universal platform *	SHO-1D, SHR-1D	230x230 mm	SP100	DH.WSO504100
Universal platform **	SHO-2D, SHR-2D	350x350 mm	SP200	DH.WSO504200
Universal platform	OB-2, RP-2	251x251 mm	-	DH.WSO604100
Universal platform	OB-2, RP-2	346x346 mm	-	DH.WSO604200
Rubber mat platform	SHO-1D, SHR-1D	270x270 mm	SP110	DH.WSO504110
Rubber mat platform	SHO-2D, SHR-2D	370x370 mm	SP210	DH.WSO504210
Rubber mat platform	OB-2, RP-2	295x295 mm	-	DH.WSO604110
Rubber mat platform	OB-2, RP-2	370x370 mm	-	DH.WSO604210

* max. 9x FH100 / FHS100, max. 7x FH250 / FHS250, max. 4x FH500 / FHS500

** max. 20x FH100 / FHS100, max. 16x FH250 / FHS250, max. 9x FH500 / FHS500

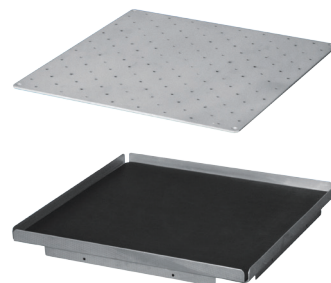

Platforms for flasks and separatory funnels

- suitable for Shaker SHO and SHR
- available in different types

Type	For device...	Dimension	Article	Order number
Platform for flasks	SHO-1D, SHR-1D	350x230x153 mm	SP120	DH.WSO504120
Platform for flasks	SHO-2D, SHR-2D	350x350x153 mm	SP220	DH.WSO504220
Platform for separatory funnels	SHO-1D, SHR-1D	350x235x174 mm	SP130	DH.WSO504130
Platform for separatory funnels	SHO-2D, SHR-2D	351x355x174 mm	SP230	DH.WSO504230
Platform for round flasks	OB-2, RP-2	350 260x153 mm	-	DH.WSO604130
Platform for separatory funnels	OB-2, RP-2	350x260x153 mm	-	DH.WSO604230

suitable separatory funnels can be found on page 221



Universal spring rack

- suitable for Shaker SHO and SHR

Type	For device...	Dimension	Article	Order number
Universal spring rack	SHO-1D, SHR-1D	270x270x100 mm	SP140	DH.WSO504140
Universal spring rack	SHO-2D, SHR-2D	370x370x100 mm	SP240	DH.WSO504240
Universal spring rack	OB-2, RP-2	295x295x100 mm	-	DH.WSO604140
Universal spring rack	OB-2, RP-2	370x370x100 mm	-	DH.WSO604240

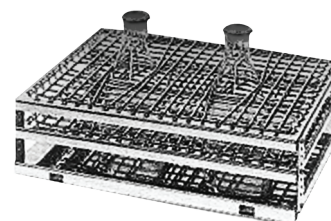

Flask holder ABS or STS

- suitable for Shaker SHO and SHR
- holder clamps variable for different flask sizes (ABS flask holder with variable size)
- mountable on universal platform

Type	For device...	For flasks...	Article	Order number
ABS flask holder	SHO, SHR	50-100 ml	FH100	DH.WIS504030
ABS flask holder	SHO, SHR	200-300 ml	FH250	DH.WIS504035
ABS flask holder	SHO, SHR	500-1000 ml	FH500	DH.WIS504040
STS wire spring flask holder	SHO, SHR	100 ml	FHS100	DH.WIS600100
STS wire spring flask holder	SHO, SHR	250 ml	FHS250	DH.WIS600250
STS wire spring flask holder	SHO, SHR	500 ml	FHS500	DH.WIS600500
STS wire spring flask holder	SHO, SHR	1000 ml	FHS1000	DH.WIS601000



Rotator

5 - 60 rpm, 0 - 90° angle, multiple discs available

RT-10 5 - 60 rpm, 0 - 90° angle



RT-10 with disk WRT120

Ideal for:

- general mixing, diffusing, dialyzing, hybridization and aerating culture
- keeping biological samples in suspension

Features:

- 5 - 60 rpm
- 0-90° angle adjustable
- digital LCD display
- smooth start and change of stirring speed while operation
- timer for 0-99 hours
- 5 different disks available
- durable construction for long life time
- CE certified and unique serial number for tracing

Safety mechanism:

- timer 99h 59min with timer-end signal
- operation LEDs
- overload protection
- locking mode

Controller:

- programmable *Jog-Shuttle* controller with touch-button

Model	RT-10
Design	turning motion
Speed range	5-60 rpm
Angle range	0-90°
Programs	6 programs, 10 steps
Timer & alarm	99hr 59min, error status timer-end
Display	digital LCD with backlight function
Controller	digital feedback controller (Jog-Shuttle)
Temperature resistance	lower than 65°C (dry air)
Safety circuit	overload protection
Dimension & weight	200x250xh260 mm, 6 kg
Packaging size	370x240xh430 mm, 8.5 kg
Power supply	1 Phase AC 120V, 60 Hz or AC 230V, 50/60 Hz
Order number 230V	DH.WRT00010
Order number 120V	DH.WRT00020

Please note: no disks included - please order separately!

Scope of supply:

- Rotator RT-10
- 4x knobs, 4x posts WRT300



4x knobs, 4x posts for installing disks
(included in scope of supply)

Article	Order number
WRT300	DH.WRT00300

Accessories:

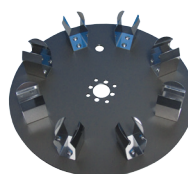

Rotator disc for 8x 50ml conical tubes

Article	Order number
WRT100	DH.WRT00100

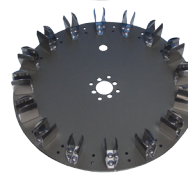

Rotator disc for 16x 15ml conical tubes

Article	Order number
WRT110	DH.WRT00110

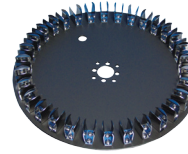

Rotator disc for 32x 1.5ml conical/centrifuge tubes

Article	Order number
WRT120	DH.WRT00120

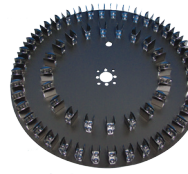

Rotator disc for 60x 1.5ml conical/centrifuge tubes

Article	Order number
WRT130	DH.WRT00130



Rotator disc for 4x 250ml flasks

Article	Order number
WRT140	DH.WRT00140

Rocker

5 - 50 rpm, tilt angle $\pm 6^\circ$ / $\pm 9^\circ$, platform included



RK-1D



RK-1D with optional stackable second platform

RK 5 - 50 rpm, settable angle

Ideal for:

- gel staining, destaining, blotting, cell culture, hybridization and washing

Features:

- 5 - 50 rpm
- 290x200 mm or 300x300 mm
- tilt angle can be set to $\pm 6^\circ$ and $\pm 9^\circ$
- digital LCD display
- smooth start and change of rocking speed while operation
- timer for 0-99 hours
- stainless steel platform with non-slip rubber pad included
- optional stackable second platform available
- 14W geared DC motor
- CE certified and unique serial number for tracing

Safety mechanism:

- timer 99h 59min with timer-end signal
- operation LEDs
- overload protection
- locking mode

Controller:

- programmable *Jog-Shuttle* controller with touch-button

Model	RK-1D	RK-2D
Design	rocker	
Platform	290x200 mm (included)	300x300 mm (included)
Speed range	5-50 rpm	
Angle	$\pm 6^\circ$ or $\pm 9^\circ$ ($\pm 9^\circ$ factory default)	
Programs	6 programs, 10 steps	
Max. load	8 kg	10 kg
Timer & alarm	99hr 59min, error status timer-end	
Display	digital LCD with backlight function	
Controller	digital feedback controller (Jog-Shuttle)	
Safety circuit	overload protection	
Dimension	290x240x150 mm	300x360x155 mm
Packaging size	450x350xh250 mm, 7 kg	450x350xh250 mm, 8 kg
Power supply	1 Phase AC 120V, 60 Hz or AC 230V, 50/60 Hz	
Order number 230V	DH.WRK01010	DH.WRK01020
Order number 120V	DH.WRK02010	DH.WRK02020

Accessories:



Second platform with 4 pillars and non-slip rubber pad

RK5011 for RK-1D	RK5021 for RK-2D
290x200 mm	300x300 mm
DH.WRK05011	DH.WRK05021

Ball mill

with 2 or 6 places, 50 - 600 rpm, programmable, soundproof cabinet optional



BML-2 with up to 2 places



BML-6 with up to 6 places

BML 5 - 600 rpm, 2 or 6 places

Ideal for:

- grinding/mixing crystalline chemicals, inks, paints, pigments, plants, racks, and soils

Features:

- antistatic rubber roller: keeps jars/pots centered
- ergonomic and compact design
- NBR roller with pot guide ring
- programmable options: 10 steps and 6 programs
- storage function for the set values of temperature and timer
- soundproof cabinet for safety and minimum noise (optional)
- backlight LCD display for RPM and timer status
- CE certified and unique serial number for tracing

Safety mechanism:

- overload protection for motor

Controller:

- programmable digital feedback controller with **Jog-Shuttle switch** (turn + push)

Model	BML-2	BML-6
Capacity	2-places, up to 2 pots	6-places, up to 6 pots
Motor	DC 40 W geared motor (5:1 ratio)	DC 100 W geared motor (5:1 ratio)
Maximum load	30 kg	60 kg
Speed	50 - 600 rpm, ± 5 rpm	
Timer	99 hrs 59 min (programmable)	
Roller dimensions (\varnothing & length)	50 x 300 mm	70 x 800 mm
External dimensions (W x D x H)	620 x 300 x 515 mm	1.200 x 500 x 795 mm
Packing size & gross weight	760 x 460 x 700 mm, 52 kg	1.300 x 620 x 1.010 mm, 115 kg
Power supply	1 Phase AC 120V, 60 Hz or AC 230V, 50/60 Hz	
Order number 230V	DH.WBM05002	DH.WBM05006
Order number 120V	DH.WBM05102	DH.WBM05106

Please note: no milling jars and balls included - please order separately!

Accessories:

Milling jars with cover

- metal lock
- seal rings
- glazed interior and exterior

Measurements Height x \varnothing	Order number
175 x \varnothing 142 mm	8 531 021
210 x \varnothing 250 mm	8 531 041
250 x \varnothing 250 mm	8 531 051

Porcelain balls, pack of 5kg

Diameter	Order number
\varnothing 15 mm	8 531 091
\varnothing 30 mm	8 531 093
\varnothing 40 mm	8 531 094
\varnothing 50 mm	8 531 095



Soundproof cabinet for ball mills, minimized noise and safe work

For device	Measurements	Article	Order number
BML-2	1.020x570xh1.120 mm	BMC2	DH.WBM505102
BML-6	1.600x770xh1.400 mm	BMC6	DH.WBM505106

SAFETY & PURIFICATION

SAFETY & PURIFICATION

Ultrasonic cleaner	137
Clean bench	141
Fume hood wet scrubber.....	142
Fume hood	142
Autoclave.....	145



Ultrasonic cleaner

analog, with lid, 1.2 l - 22 l, integrated controller, HF frequency 40 kHz

WUC-A analog, with lid

Ideal for:

- cleaning to remove dirt, grease, waxes and oil from all lab instruments by ultrasonic frequency

Features:

- made of stainless steel, finished surface
- convenient preset function of heating and timer
- HF frequency 40 kHz
- bottom-mounted drain valve (WUC-A10H and WUC-A22H)
- maximum 30 minutes cleaning time
- CE certified and unique serial number for tracing

Controller:

- **analog** controller for timer, temperature and output control



WUC-A06H with lid and valve



Model	WUC-A01H*	WUC-A02H*	WUC-A03H	WUC-A06H	WUC-A10H	WUC-A22H
Capacity	1.2 l	1.8 l	3.3 l	6 l	10 l	22 l
HF-peak-out	72 W	75 W	124 W	168 W	265 W	379 W
Heating temperature & power	ambient or 65°C fixed, 86 W		ambient to 85°C, 172 W		ambient to 85°C, 258 W	ambient to 85°C, 275 W
Timer	-	0 - 30 min.				
Drain-valve	-				1/2" NPT	
Inner tank size (WxDxH)	150 x 135 x 60 mm	150 x 135 x 100 mm	240 x 140 x 100 mm	290 x 150 x 150 mm	290 x 240 x 150 mm	500 x 300 x 150 mm
Weight	1.8 kg	2.5 kg	4 kg	5.3 kg	7 kg	11 kg
Packing size & gross weight	200 x 200 x 190mm, 3 kg	200 x 200 x 240mm, 4 kg	320 x 200 x 290mm, 5 kg	370 x 220 x 350mm, 6 kg	434 x 320 x 360mm, 7 kg	640 x 380 x 370mm, 11 kg
Power consumption	158 W	161 W	296 W	340 W	523 W	654 W
Power supply	1 Phase AC 120V, 60 Hz or AC 230V, 50/60 Hz					
Order number 230V	DH.WUC.A01H	DH.WUC.A02H	DH.WUC.A03H	DH.WUC.A06H	DH.WUC.A10H	DH.WUC.A22H
Order number 120V	DH.WUC.A101H	DH.WUC.A102H	DH.WUC.A103H	DH.WUC.A106H	DH.WUC.A110H	DH.WUC.A122H

Note: no basket included, please order separately.

* WUC-A01H and WUC-A02H with flip switch

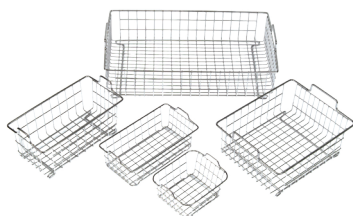

Stainless steel wire baskets for ultrasonic cleaner WUC-A

For device	Capacity	Measurements	Article	Order number
WUC-A02H	1.8 l	120x105xh65 mm	B02	DH.WUC.B02
WUC-A03H	3.3 l	215x115xh65 mm	B03	DH.WUC.B03
WUC-A06H	6 l	247x123xh96 mm	B06	DH.WUC.B06
WUC-A10H	10 l	262x206xh93 mm	B10	DH.WUC.B10
WUC-A22H	22 l	452x263xh93 mm	B22	DH.WUC.B22

Ultrasonic cleaner

digital, with lid and basket, 3.3 l - 22 l, integrated controller, HF frequency 40 kHz

WUC-D digital, with lid & basket

Ideal for:

- cleaning to remove dirt, grease, waxes and oil from all laboratory instruments by ultrasonic frequency

Features:

- convenient preset function of heating and timer
- HF frequency 40 kHz
- multi frequency sonication body
- temperature range from ambient to 80°C
- bottom-mounted drain valve (WUC-D10H and WUC-D22H)
- maximum 60 minutes cleaning time
- microprocessor control: timer, temperature and output control
- FND display
- CE certified and unique serial number for tracing
- WUC-D03H model includes degassing function for very strong cleansing

Controller:

- **digital** controller for timer, temperature and output control



Model	WUC-D03H	WUC-D06H	WUC-D10H	WUC-D22H
Capacity	3.3 l	6 l	10 l	22 l
HF-peak-out	100 W	253 W	407 W	528 W
Heating temperature & power	ambient to 80°C, 172 W		ambient to 80°C, 258 W	ambient to 80°C, 344 W
Timer	0 - 30 min.	0 - 60 min.		
Drain-valve	-		1/2" NPT	
Inner tank size (WxDxH)	240 x 140 x 100 mm	290 x 150 x 150 mm	240 x 140 x 150 mm	500 x 300 x 150 mm
Weight	3.4 kg	5.8 kg	8 kg	12.9 kg
Packing size & gross weight	320 x 200 x 290 mm, 3.7 kg	360 x 220 x 350 mm, 6.3 kg	440 x 320 x 360 mm, 8.5 kg	640 x 380 x 370 mm, 13.4 kg
Power consumption	290 W	425 W	665 W	872 W
Power supply	1 Phase AC 120V, 60 Hz or AC 230V, 50/60 Hz			
Order number 230V	DH.WUC.D03H	DH.WUC.D06H	DH.WUC.D10H	DH.WUC.D22H
Order number 120V	DH.WUC.D103H	DH.WUC.D106H	DH.WUC.D110H	DH.WUC.D122H

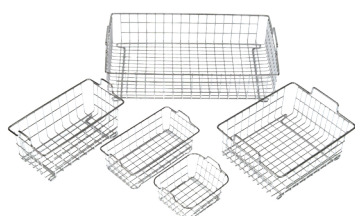

Stainless steel wire baskets for ultrasonic cleaner WUC-D

For device	Capacity	Measurements	Article	Order number
WUC-D03H	3.3 l	215x115xh65 mm	B03	DH.WUC.B03
WUC-D06H	6 l	247x123xh96 mm	B06	DH.WUC.B06
WUC-D10H	10 l	262x206xh93 mm	B10	DH.WUC.B10
WUC-D22H	22 l	452x263xh93 mm	B22	DH.WUC.B22

Ultrasonic cleaner

digital, with lid and external controller, 30 l - 74 l, HF frequency 40 kHz

WUC-N digital, large, with lid

Ideal for:

- cleaning to remove dirt, grease, waxes and oil from all laboratory instruments by ultrasonic frequency

Features:

- remote generator: power control and timer function with LCD display
- BTL sonicator installed: robust and stable running
- sweep function can realize complete cleaning by the dispersion of ultrasound
- auto optimization of frequency as various water level and temperature
- foot switch control
- temperature range from ambient to 105°C
- full set with lid, foot switch and generator
- drain mounted in the bottom
- HF frequency 40 kHz
- maximum 99 minutes cleaning time
- CE certified and unique serial number for tracing

Controller:

- **digital** remote controller for timer, temperature and output control



WUC-N47H with basket (not included) and remote controller

Model	WUC-N30H	WUC-N47H	WUC-N60H	WUC-N74H
Capacity	30 l	47 l	60 l	74 l
HF-peak-out	704 W	990 W	1,210 W	1,430 W
Heating temperature & power	ambient to 105°C, 990 W			
Timer	0 - 99 min.			
Outer tank size (WxDxH)	480 x 380 x 400 mm	530 x 430 x 450 mm		580 x 480 x 450 mm
Inner tank size (WxDxH)	400 x 300 x 250 mm	450 x 350 x 300 mm	500 x 400 x 300 mm	550 x 450 x 300 mm
Weight	26 kg	31 kg	36 kg	41 kg
Packing size & gross weight	620 x 520 x 640 mm, 32 kg	670 x 570 x 710 mm, 37 kg	720 x 620 x 710 mm, 42 kg	770 x 670 x 710 mm, 47 kg
Power consumption	4.694 W	1.980 W	2.200 W	2.420 W
Power supply	1 Phase AC 120V, 60 Hz or AC 230V, 50/60 Hz			
Remote generator power	600 W	900 W	1,200 W	1,500 W
Remote generator weight	9 kg	10 kg		
Order number 230V	DH.WUC.N30H	DH.WUC.N47H	DH.WUC.N60H	DH.WUC.N74H
Order number 120V	DH.WUC.N130H	DH.WUC.N147H	DH.WUC.N160H	DH.WUC.N174H

Note: no basket included, please order separately.



Stainless steel wire baskets for ultrasonic cleaner WUC-N

For device	Capacity	Measurements	Article	Order number
WUC-N30H	30 l	340x240xh150 mm	Ba7021	DH.Ba7021
WUC-N47H	47 l	390x290xh200 mm	Ba7022	DH.Ba7022
WUC-N60H	60 l	440x340xh200 mm	Ba7023	DH.Ba7023
WUC-N74H	74 l	490x390xh200 mm	Ba7024	DH.Ba7024

Clean bench

WLC-V

Class 100 HEPA filter & vertical air flow

The laminar flow clean bench provides reliable protection for samples and work processes against particulate contamination. The air from above the cabinet vertically goes through a pre-filter and a class 100 HEPA filter with an efficiency up to 99.97% & 0.3 micron size.

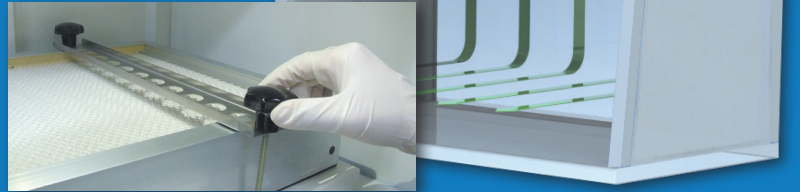

UV lamp

The built-in UV lamp contributes to a better sterilization. The UV lamp automatically turns off when the front door is opened.



Door

Easy to open tempered glass sliding door ensures safe operation and protection against UV radiation.



Operation of different types of devices within the clean bench due to two built-in power connections.



Connection of two different gas types possible.

Connections

Controller

Intuitive touch-button controller. 8-step control of air-flow speed. Timer function for UV lamp.

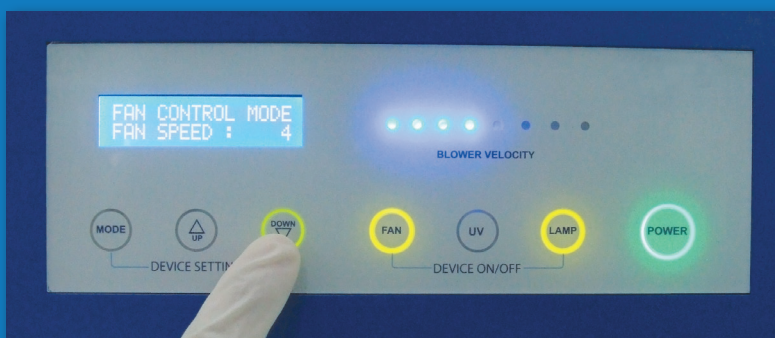

Clean bench

integrated HEPA filter, vertical air flow, UV lamp, built-in gas and power connections



WLC-V1200

WLC-V with HEPA filter

Ideal for:

- protection of samples and work processes against dust and particulate contamination

Features:

- class 100 HEPA filter of efficiency up to 99.97% & 0.3 micron size (easy to exchange)
- mesh guard for HEPA filter protection
- vertical air flow-type
- optimized air flow system for uniform air flow/velocity
- 8 steps air velocity control
- UV and fluorescent lamp, external gas connection valve, internal electrical outlet
- silent and vibration-free blower (under 65 dB)
- corrosion resistant 304 stainless steel working table interior, powder-coated body and tempered safety glass sliding door for protection from UV radiation
- 99hr 59min Timer
- high-quality backlight LCD display
- CE certified and unique serial number for tracing

Safety mechanism:

- UV protection system: UV lamp is only activated when safety glass door is completely closed

Controller:

- microprocessor digital controller
- high performance touch input

Model	WLC-V1200	WLC-V1500	WLC-V1800
Air volume	1,350 m ³ /h	1,700 m ³ /h	2,020 m ³ /h
Air flow velocity	8 steps, 0.3 - 0.6 m/s		
HEPA filter	Class 100 0.3 µm particle removal 99.97%		
Pre-filter	3-30 µm particle removal		
Lamp	1 x UV 20 W, 1 x FL 36 W	1 UV 30 W, 1 x FL 55 W	
Utility device	1 x air cock, 1 x gas cock, 2 x 230V outlet		
Internal dimensions (W x D x H)	1,200 x 660 x 610 mm	1,500 x 660 x 610 mm	1,800 x 660 x 610 mm
External dimensions (W x D x H)	1,280 x 735 x 1,895 mm	1,580 x 735 x 1,895 mm	1,880 x 735 x 1,895 mm
Power supply	1 Phase AC 120V, 60 Hz or AC 230V, 50/60 Hz		
Order number 230V	DH.WLCV1200	DH.WLCV1500	DH.WLCV1800
Order number 120V	DH.WLCV1201	DH.WLCV1501	DH.WLCV1801

Spare HEPA filter for clean bench WLC-V

For device	Order number
WLC-V1200	DH.MXCB.S003
WLC-V1500	DH.MXCB.S004
WLC-V1800	DH.MXCB.S005



Fume hood | wet scrubber

NEW

Air Curtain or Bypass air flow, 1,500 mm/1,800 mm/2,100 mm/2,400 mm



HD-1500S

HD / HD-C

Ideal for:

- required equipment for air pollution preventing

Features:

- moving the experiment polluted air and toxic gases generated in the laboratory of the scrubber through duct structure and only the purified air discharged to the atmosphere after the contaminants have been removed
- PVC for excellent acid and chemical resistance
- with air-, gas, and water cock, drain, explosion proof lamp, receptacle, and multi-purpose cabinet
- built-in wet scrubber: with circulation pump, water level gauge, water storage tank, pall ring filter, demister, water spray nozzle, pH indicator/control panel
- acidified water drained to neutralize
- the current pH- level can be check through the pH meter display
- gas leakage to the outside is completely blocked

Model	HD-1500S	HD-1800S	HD-2100S	HD-2400S
	Bypass air flow			
	HD-C1500S	HD-C1800S	HD-C2100S	HD-C2400S
	Air Curtain air flow			
Duct size	Ø200 mm		Ø250 mm	
Sash frame and window	PVC, clear PVC			
Cabinet	multi-purpose cabinet			
Lamp	explosion proof lamp, 2 x 20W			
Cock	1 x air-, gas- and water cock			
Receptacle	2 x 230V and 2 x 120V			
Circulation pump	built-in magnetic pump, 1 Phase, AC 230V, 1/3 HP			
Water spray nozzle	6 mm PVC-nozzle			
Material	internal, external, work top: PVC window: clear PVC pH-indikator/control panel, demister: PP			
Internal dimensions (W x D x H)	1500 x 800 x 2200 mm	1800 x 800 x 2200 mm	2100 x 800 x 2200 mm	2400 x 800 x 2200 mm
Power supply	1 Phase, AC 230V / 60 Hz			
Order number Bypass air flow, 230V	DH.WHD02515	DH.WHD02518	DH.WHD02521	DH.WHD02524
Order number Air Curtain air flow, 230V	DH.WHD02615	DH.WHD02618	DH.WHD02621	DH.WHD02624

***Bypass air flow:** After the suction forcing the indoor air to discharge the gas to the outside.

****Air Curtain air flow:** The outdoor air is sucked through the air curtain to the front chamber, and the exhaust gas back to the suction air.

Optional, external blower

Article	Oder number
HDBL0011	DH.WHD10011

NEW

Dishwasher

ambient +5°C to 95°C, washing surface 0.52 m², 400 l/min, max. 5 bar

WGW-400

Ideal for:

- gentle and fast cleaning of laboratory articles

Features:

- outstanding fast washing cycle and optimal cleaning results
- easy use and safety due to the telescopic sliding rail
- water, detergent, distilled water are automatically injected into the wash chamber via pumps
- with double layer wall for sound proof and heat resistance
- offers efficient washing program cycles: 6 pre-set programs and 1 customizable programm

Safety mechanism:

- special steam condensing mechanism for user safety
- automatic door lock system

Controller:

- digital fuzzy controller (fully-automatic)



WGW-400
optional rack, not included in scope of supply!

Model	WGW-400	
Total washing surface	0.52 m ²	
Temperature range	ambient +5°C to 95°C	
Wash pump	400 l/min, water pressure: 3 - 5 bar, water consumption: 8 - 10 l	
Shelves	1 x wire basket included	
Safety mechanism	overheat-, over pressure- and over-current protection, sensor error detection	
Programing function	6 preset programs & 1 customizable program	
Controller	digital fuzzy controller (fully automatic)	
Display	digital LCD display with mit back light function	
Material	304# stainless steel (internal and external)	
Power consumption	5 kW	
Dimensions (W x D x H)	Internal	508 x 515 x 407 mm
	External , net weight	600 x 625 x 870 mm, 95 kg
Power supply	1 Phase, AC 120V, 60 Hz or 1 Phase, AC 230V 50 / 60 Hz	
Order number 230V	DH.WGW0400*	
Order number 120V	DH.WGW0401*	

Customizable accessories (racks / baskets / etc.) available on request!

* Models not available in Europe

Stainless steel rack (included)

Article	Dimensions	Oder number
Wire basket, for the rail	495 x 510 mm	DH.WGW01001

Optional liquid cleaning detergent and rinse

Article	Canister	Oder number
Potassium Hydroide liquid cleaning detergent	18 l	DH.WGW02010
Non ionicsurfactant liquid rinse	18 l	DH.WGW02011

Optional stainless steel rack for various vessels

Article	Dimensions	Oder number
Injection rack	495 x 510 mm	DH.WGW01002

Autoclave

WAC
WAC-R

Safety electronic door locking system

Sterilizing cycle only starts when the door is locked. Electro-mechanical sensor, magnetic latch, and one-touch open button work together to implement the perfect safety door, which can be opened only when the temperature and pressure has dropped to a safe level inside the pressure vessel.

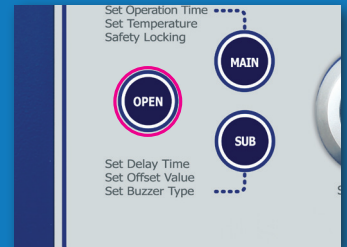
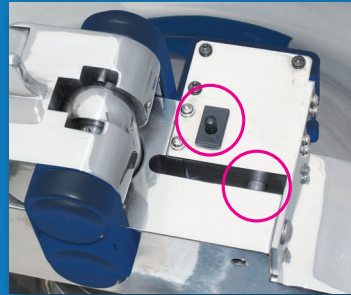

Special steam condensing mechanism

Hot steam generated by sterilizing cycle is not released out directly. It is condensed into a small amount of water just after the sterilizing cycle by a special condensing mechanism, which protects the user from dangerous high temperature steam.

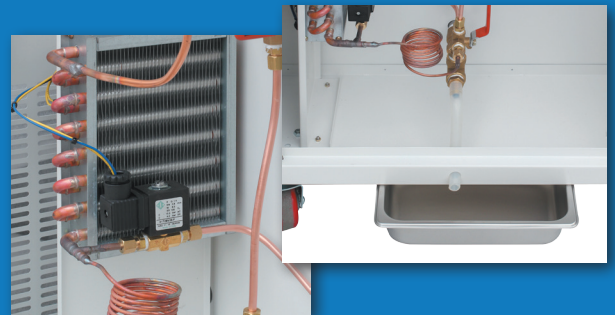

Lever-type sliding door

Opening and closing the autoclave door is smooth and easy due to the lever-type sliding door.



Liquid & solid cycle mode

Optional operation in liquid and solid cycle mode. During liquid mode the temperature decreases very slow and steam is released step by step, during solid mode the temperature decreases very fast and steam is released directly.



Sterilization cycle data recorder

The WAC-R models come along with a built-in recorder which allows to analyse the process of temperature, pressure, time and error status during the sterilization process.



Operation Date : 2014.01.08
Operation Time : 14:25:02
Operator : YSI-01
Cycle Type : SOLID

1 STEP : HEAT (H)
2 STEP : STERILIZATION (S)
3 STEP : EXHAUST (E)
4 STEP : DRY (D)

Start Time : 17:04:00
Set Temp. : 121.0°C
Set Time : 00:15

STEP	TIME	TEMP.	PRESSURE
H	17:04:00	88.0°C	0.4
H	17:07:01	95.8°C	0.5
H	17:16:02	102.6°C	0.6

IQ | OQ
available
page 12 for details



WAC-R80 with built-in recorder

WAC / WAC-R

Ideal for:

- biotechnology, clinical, environmental, medical and food industry

Features:

- stainless steel wire basket (2 pcs. included) and pressure vessel
- powder-coated steel body
- top loading sterilizer for loading of large working volume
- thermal printer (record paper roll w58/ Ø 40 mm) (WAC-R)
- solid and liquid mode
- with casters for excellent mobility
- digital backlight LCD display
- digital timer function – delay time and operation time can be controlled
- built-in recorder: print sterilization data (only WAC-R)
- CE certified and unique serial number for tracing

Safety mechanism:

- overheat and over-current protection
- automatic over pressure release valve & heat-protective lid
- error alarm, power failure and temperature error
- water low level detection
- electronic door lock sensing system (locks the door over 80°C)

Controller

- digital fuzzy controller (fully automatic)

Model	WAC-47 / WAC-R47		WAC-60 / WAC-R60		WAC-80 / WAC-R80	
Capacity	47 l		60 l		80 l	
Temperature range & accuracy	room temperature ±0.5°C to 132°C, ±0.5°C at 121°C					
Pressure & gauge	1.2 kgf/ cm ² at 121°C / 2.0 kgf/ cm ² at 132°C, 0 - 3 kgf/ cm ²					
Heating power (consumption)	2 kW		3 kW		3 x 1.5 kW	
Door & closing system	lever type sliding door/ safety electronic door closing system					
Basket dimensions	Ø270 x 240 mm		Ø320 x 240 mm		Ø370 x 240 mm	
Internal dimensions (W x D x H)	Ø300 x 670 mm		Ø350 x 650 mm		Ø400 x 650 mm	
Outer dimensions (W x D x H)	700 x 470 x 1080 mm				810 x 580 x 1140 mm	
Packing size & gross weight	700 x 470 x 1,080 mm, 117 kg		700 x 470 x 1,080 mm, 120 kg		810 x 580 x 1140 mm, 170 kg	
Power supply	1 Phase AC 120V, 60 Hz or AC 230V, 50/60 Hz				3 Phase AC400V, 50/60Hz, with terminal block	
without PED* certification, 2,0 mm tank	Order number WAC	230V	DH.WAC05047	DH.WAC05060	-	
		120V	DH.WAC06047	DH.WAC06060	-	
		3 Phase	-	-	DH.WAC07080	
	Order number WAC-R**	230V	DH.WACR2047	DH.WACR2060	-	
		120V	DH.WACR1047	DH.WACR1060	-	
		3 Phase	-	-	DH.WACR3080	
NEW with PED* certification, 3,0 mm tank	Order number WAC-P	230V	DH.WAC05047P	DH.WAC05060P	-	
		120V	DH.WAC06047P	DH.WAC06060P	-	
		3 Phase	-	-	DH.WAC07080P	
	Order number WAC-RP**	230V	DH.WACR2047P	DH.WACR2060P	-	
		120V	DH.WACR1047P	DH.WACR1060P	-	
		3 Phase	-	-	DH.WACR3080P	

* PED (pressure equipment directive) certification, IQ/OQ only without PED certification available.

** Recorder-type: built-in recorder printer, sterilization cycle data (date, temperature, pressure, time, error status, etc.)

Autoclave | bench-top **NEW**

up to 135°C, microwave sterilization, max. 7 - 15min cycles



Microjet compact, personal, rapid

Ideal for:

- biotechnology, clinical, environmental, medical and food industry

Features:

- for liquid media up to 500ml (vessel diameter max. 120mm)
- sterilization temperature 135°C
- total process time between 7 and 15 minutes (depending on selected volume)
- brand new sterilization mechanic
- microwaves from the bottom heating up the media immediate and uniform
- compact design enables using in every laboratory without need of much space
- data logging function and software for creating reports (GLP)
- CE & IP 20 certified

Controller:

- self-explanatory illuminated **touchscreen controller**
- every sterilization step before, during and after a cycle is shown on the display
- documentation of every cycle on a micro SD card

Model	Microjet
Design	bench-top
Temperature range	135°C
Pressure	3.4 bar
Protection	IP 20
Heating time	1.5 - 4.5min
Cooling time	4 - 12min
Total process duration	7 - 15min
Temperature after process completion	95°C
EM wave frequency	2450 MHz
Controller	digital touchscreen controller with data logging function
Chamber size	Ø 125mm, height 240mm
Dimension & weight	280 x 280 x 427mm, 15kg
Power supply	AC 230V, 50/60 Hz
Order number 230V	6 300 230

Scope of supply: Microjet, power plug, micro SD card, software

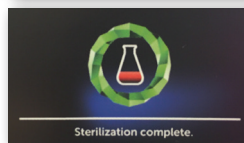
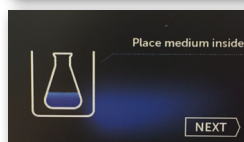
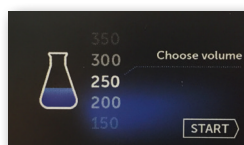

All functions are operated from the touchscreen. The whole sterilization process is shown and every step documented on the micro SD card.

During the whole process, the door is locked and can't be opened by accident.

A revolution in sterilization of liquid media!

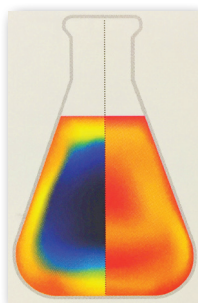

In the Microjet autoclave the thermal energy required for sterilization is supplied directly to the medium. Microwaves from the bottom of the chamber are used as energy source so that the heating of the medium is immediate and uniform.



Spare wire basket for autoclaves, stainless steel

For device	Measurement	Article	Order number
WAC-47/-R47	Ø270 x h240 mm	Ba7011	DH.Ba7011
WAC-60/-R60	Ø320 x h240mm	Ba7012	DH.Ba7012
WAC-80/-R80	Ø370 x h240mm	Ba7013	DH.Ba7013

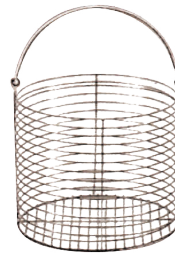

Spare basket, perforated bottom, stainless steel

For device	Measurement	Article	Order number
WAC-47/-R47	Ø270 x h250 mm	WAC20047	DH.WAC20047
WAC-60/-R60	Ø320 x h250 mm	WAC20060	DH.WAC20060
WAC-80/-R80	Ø370 x h250 mm	WAC20080	DH.WAC20080



Spare paper for thermo printer (only WAC-R devices)

Pack	Order number
5 pcs./Pack	DH.WACR5005

Sterilisations indicator tapes

Indicator	Size	Color	Order number
dry heat	19 mm x 50 m/roll	white → brown	KA.1051
ethylene oxid gas		red → green	HH.1080551
autoclave / steam		green → brown	HH.1080550

NEW



Dry heat sterilisation indicator, labels on sheet

Color	Changing time	Order number
pink → brown	30 Min. at 180°C, 3 h at 160°C	AS2.6419.01

NEW

Anabac Deodorant "Classic", ideal for deodorization in autoclaves, franchi bracing fragrance

Deodorant capacity	Pack	Order number
200 l/tablet	100 tablets in PP/Paper container	AS2.6361.01

NEW

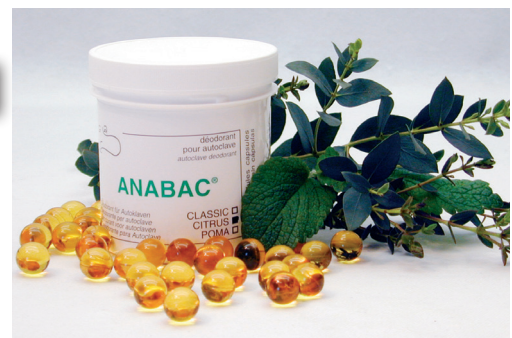

SEPARATION & FILTRATION



SEPARATION & FILTRATION

Centrifuge	149
Evaporator	152
Filtration (filter holder).....	156
Filtration system	166
Manifold	168
Suction system	173

Centrifuge

small size, up to 5,500 rpm, different rotors included

up to 5,500 rpm



CF-5 with circular fixed angle rotor



Operation LEDs

CF-5 Mini centrifuge 5,500 rpm

Ideal for:

- plasmid, DNA and RNA work, miniprep kit, and many other applications

Features:

- quick spin down from walls or caps of centrifuge tubes
- complete set with circular fixed-angle rotor and fixed strip rotor
- smooth opening of the lid by simply pressing
- body and rotor made of ABS
- clear and transparent lid (polycarbonate)
- CE/GMP certified and unique serial number for tracing

Safety mechanism:

- lid-activated on/off safety switch: close the clear lid to start and open to stop

Controller:

- superior linearity for the control of stirring speed by specially designed control circuit (PWM control)

Model	CF-5
RPM & max. RCF	5,500 rpm, 1,775 x g
Max. capacity	6 x 0.5-/1.5-/2.0- ml tubes, 2 x 0.2 ml PCR 8-tube strip or 16 x 0.2 ml PCR 8 tubes
Angle rotor (included)	6 holes circular fixed-angle rotor for 0.5-/1.5-/2.0- ml tubes
Strip rotor (included)	16 holes strip rotor for 0.2 ml PCR 8-tube strip or individual tubes
Adapter (included)	6 x 0.2-/0.5- ml tube adapter included
Dimension	178 x 150 x 109 mm
Packing size	200 x 180 x 175 mm, 2 kg
Power consumption	8 W
Power supply	1 Phase AC 120V, 60 Hz or AC 230V, 50/60 Hz
Order number 230V	DH.WCF00005
Order number 120V	DH.WCF00025



Circular fixed angle rotor (included)
for 6x 0.2/0.5/1.5/2.0ml tubes

	Order number
CFAR1512M	DH.WCF00105



Tube adapter (6 pieces)
for circular fixed angle rotor

	Order number
for 0.2ml tubes	DH.WCF00201
for 0.5ml tubes	DH.WCF00301

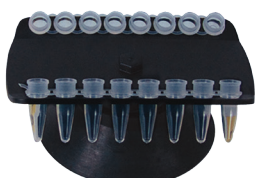

Fixed strip rotor (included)
for 2x 0.2ml PCR8-tube strips or 16x 0.2ml PCR tubes

	Order number
CFPR8	DH.WCF00205

Accessories: Centrifuge tubes and reaction vessels on page 237

Centrifuge

optimized design, compact size, 5,500 rpm, accessories included

NEW



CF-6

CF-6 mini-centrifuge, 5,500 rpm

Ideal for:

- quick spin down from walls or caps of centrifuge tubes for plasmid, DNA- and RNA-preparation and many other applications

Features:

- optimized design: lighter and more compact than CF-5
- complete set with two rotors and tube adapters
- smooth opening of the lid by simply pressing
- body and rotor made of ABS
- clear and transparent lid (polycarbonate)
- CE certified and unique serial number for tracing

Safety mechanism:

- rapid stop of the spinning motion when opening
- lid-activated on/off safety switch: close the clear lid to start and open to stop

Controller:

- analog PWM controller

Model	CF-6
RPM & max. RCF	5,500 rpm, 1,775 x g
Max. capacity	6 x 0.5-/1.5-/2.0- ml tubes, 2 x 8-tube strip with 0.2 ml tubes or 16 x 0.2 ml tubes
Angle rotor (included)	6 holes for 0.5-/1.5-/2.0- ml tubes
Strip rotor (included)	16 holes strip rotor for 0.2 ml PCR 8-tube strip or individual tubes
Adapter (included)	adapter for 6 x 0.2 ml + 6 x 0.5- ml tubes included
Dimensions, net weight	144 x 192 x 108 mm, 1.1 kg
Verpackungsgröße, Bruttogewicht	175 x 255 x 215 mm, 1.6 kg
Power consumption	8 W
Power supply	1 Phase AC 120V, 60 Hz or AC 230V, 50/60 Hz
Order number 230V	DH.WCF00006
Order number 120V	DH.WCF00026



Circular fixed angle rotor (included)

	Order number
for 6 x 0.2/0.5/1.5/2.0 ml tubes	DH.WCF00105

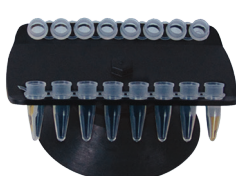

Strip rotor (included)

	Order number
2 x 8-strip with 0.2 ml tubes 16 x 0.2 ml tubes	DH.WCF00205



Tube adapter set (6 pieces) for circular fixed angle rotor

	Order number
for 0.2ml tubes	DH.WCF00201
for 0.5ml tubes	DH.WCF00301

Accessories: Centrifuge tubes and reaction vessels on page 239

NEW

Centrifuge

high-performance, up to 13,500 rpm, accessories included

CF-12 up to 13,500 rpm

Ideal for:

- plasmid-, DNA-, RNA-, protein-preparation, cell cultures, cell harvest, subcellular separation and many other applications

Features:

- new design: space saving, stable and robust
- brushless DC motor, quiet operation (≤ 57 dB)
- digital feedback controller for speed
- rotor lid for operation and noise minimization
- acceleration and brake time less than 15 sec. (at max. rpm)
- storage function for the set values of rpm and timer
- case made from ABS, rotor made from PE, PC lid
- soft brake function to protect delicate samples
- useful exclusive spin-down function
- backlight LCD display
- CE certified and unique serial number for tracing

Safety mechanism:

- safety system for motor errors, display of error messages, exceeding of speed, open lid
- electronic safety lid lock system during the operation and automatic lid opening
- load imbalance detection

Controller:

- digital feedback control with *Jog-Shuttle switch*

up to
13,500 rpm

CF-12

Model	CF-12
RPM & max. RCF	1,000 - 13,500 rpm, 12,225 x g
Acceleration / braking time	≤ 12 sec. (at max. speed)
Angle rotor (included)	rotor for max. 12 x 0.2-/0.5-/1.5-/2.0- ml tubes
Adapter (inklusive)	adapter for 6 x 0.2 ml + 6 x 0.5- ml tubes included
Dimensions	187 x 253 x 155 mm, 3.8 kg
Packing size	230 x 290 x 245 mm, 4.3 kg
Power consumption	90 W
Power supply	1 Phase AC 120V, 60 Hz or AC 230V, 50/60 Hz
Order number 230V	DH.WCF01350
Order number 120V	DH.WCF01351



Optional inner lid
made from PP, sample protection from contamination

Order number

DH.WCF21350

Tube adapter set (12 pieces)

	Order number
for 0.2ml tubes	DH.WCF00200
for 0.5ml tubes	DH.WCF00300
rotor, autoclavable, 12 x 0.2/0.5/1.5/2.0 ml tubes	DH.WCF11350



Accessories: Centrifuge tubes and reaction vessels on page 239

Evaporator, greaseless

Rotary vacuum evaporator with greaseless joints, diagonal or vertical model



witegvapor greaseless joints

Ideal for:

- all distilling applications with high vacuum pressure

Features:

- diagonal and vertical model
- digital display
- for flasks from 50 - 3,000 ml
- speed range from 20 - 280 rpm
- easy height control by accurate motor with up/down buttons
- double-binding PTFE and NBR nitrile vacuum seal
- anti-abrasion, anti-aging, anti-chemical
- leaning angle can be adjusted
- included water bath is made of stainless steel
- special glassware for greaseless usage

Safety mechanism:

- insulated heater
- double-jacketed bath body
- low water level detection and automatic stop function

Controller:

- built-in digital controller with LCD display

Model	diagonal	vertical
Speed range	20 - 280 rpm	
Flask types suitable	50 - 3,000 ml	
Bath size	Ø 245 mm x h120 mm	
Bath temperature	up to 180°C	
Bath material	stainless steel SUS304	
Dimension	730 x 410 x 630 mm, 19.5 kg	620 x 410 x 870 mm, 19.5 kg
Packing size	800 x 600 x 600 mm, 25 kg	
Power supply	1 Phase AC 230V, 50/60 Hz	
Order number	2 600 000	2 610 000

Scope of supply:

- evaporator
- water bath
- 1,000 ml evaporating flask with ground joint socket ST 29/32
- 500 ml receiver flask round bottom with spherical joint socket KS 35
- clamps and connections
- condenser
- power cable
- manual

Recommended vacuum pump: Rocker 300C



Model	Rocker 300C	
Voltage	120V / 60Hz	230V / 50Hz
Max. vacuum	173 mbar	
Max. flow rate	23 l/min	20 l/min
Motor rotation	1,750 rpm	1,450 rpm
Horse power	1/8 HP	
Noise level	50 dB	
Port thread	5/16 inch (8 mm)	
Order number	00829 189300-11	00829 189300-22

Spare parts witegvapor

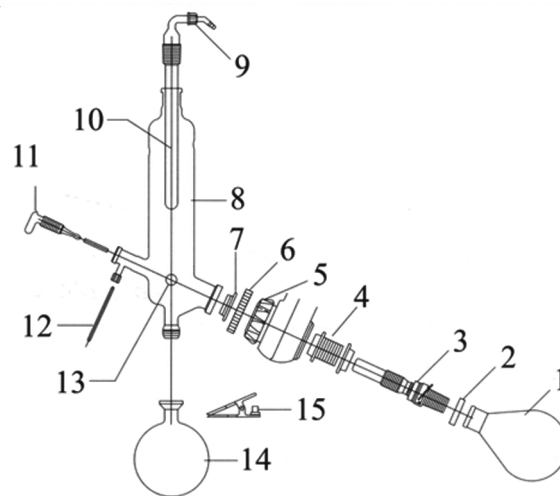
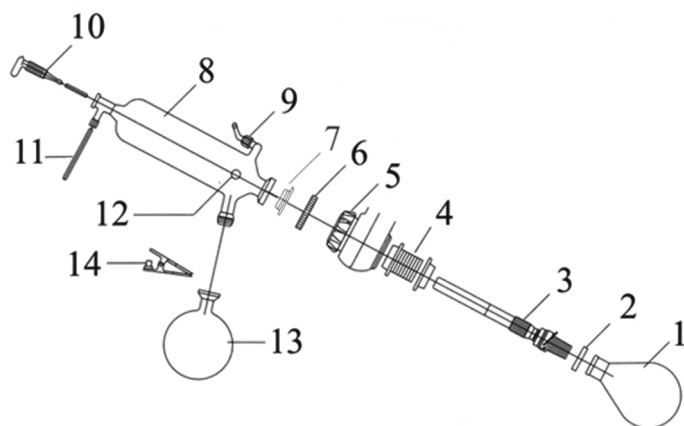

Spare parts for diagonal evaporator witegvapor

Item	Article	Order number
1	evaporating flask	0 655 001 FCH-V
2	joint clamp	0 131 329
3	witegvapor duct	2 600 0072
4	dust screw cap	2 600 040
5	condenser screw coupling	2 600 041
6	condenser holder spring	2 600 042
7	vacuum seal	2 600 018
8	assembly condenser	2 600 009
9	vacuum connector	2 600 044
10	vacuum stopcock	2 600 010
11	drawing PTFE hose	2 600 019
12	vapor sensor	2 600 020
13	receiving flask 500 ml KS 35	0 644 500 ROT
14	receiving flask clamp	0 133 035

Spare parts for vertical evaporator witegvapor

Item	Article	Order number
1	evaporating flask	0 655 001 FCH-V
2	joint clamp	0 131 329
3	witegvapor duct	2 600 0072
4	dust screw cap	2 600 040
5	condenser screw coupling	2 600 041
6	condenser holder spring	2 600 042
7	vacuum seal	2 600 018
8	assembly condenser	2 600 009
9	vacuum connector	2 600 044
10	vacuum adapter	2 600 045
11	vacuum stopcock	2 600 010
12	drawing PTFE hose	2 600 019
13	vapor sensor	2 600 020
14	receiving flask 500 ml KS 35	0 644 500 ROT
15	receiving flask clamp	0 133 035

witegvapor duct ST 24/29 (Item 3)

Material	Length	Order number
PTFE	312 mm	2 600 0071 TEF
PTFE	200 mm	2 600 0072 TEF
glass	312 mm	2 600 0071
glass	200 mm	2 600 0072



Four neckbulbs for flasks

Connectors	Order number
ST 24 socket 4x ST 14 cone	1 430 400

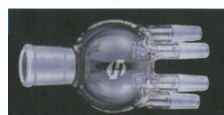

Connection adapter

Size	Order number
ST24 -> ST14	0 510 002
ST29 -> ST24	0 510 006

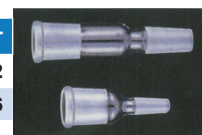

Bulbs for flasks

Size	Order number
ST 24, l=100 mm	1 430 224
ST 25, l=250 mm	1 430 230
ST 29, l=100 mm	1 430 190
ST 29, l=250 mm	1 430 200

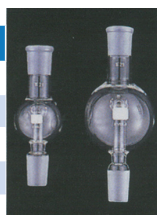

Receiver flask KS 25 Rotulex

Capacity	Order number
100 ml	0 644 100 ROT
250 ml	0 644 250 ROT
500 ml	0 644 500 ROT
1,000 ml	0 644 001 ROT
2,000 ml	0 644 002 ROT
3,000 ml	0 644 003 ROT



Evaporating flask ST 29/32 FCH-V

Capacity	Order number
50 ml	0 655 050 FCH-V
100 ml	0 655 100 FCH-V
250 ml	0 655 250 FCH-V
500 ml	0 655 500 FCH-V
1,000 ml	0 655 001 FCH-V
2,000 ml	0 655 002 FCH-V
3,000 ml	0 655 003 FCH-V



Chiller

-20°C - +40°C, external, heavy-duty refrigerated circulator, 20-/30 l/min.



CHI **NEW**

Ideal for:

- temperature control system for 1 - 50 l evaporators, cooling lines, etc.

Features:

- built-in, external nozzle for prevention of nozzle damage
- internal bath made from stainless steel (prevents corrosion)
- effective cooling capacity
- high quality circulation pump: max. flow rate 20- 30 l/min. and max. pressure 1.0/3.3 bar
- safety connection ports for connection with pipe for fluid in- and respectively outlet, made from stainless steel
- integrated pump and compressor pressure gauge
- CE certified and unique serial number for tracing

Safety mechanism:

- emergency stop button

Controller:

- digital **PID controller** for best temperature accuracy

Model	CHI-20	CHI-30	CHI-50	
Temperature range & -stability	-20°C - +40°C, ±0.2°C at 15°C			
Filling volume cooling fluid	max. 17 l	max. 29 l	max. 47 l	
For XX l evaporators	for 1 - 20 l evaporators	for 10 - 30 l evaporators	for 20 - 50 l evaporators	
Refrigerator capacity (HP)	0.37 kW	0.74 kW	1.47 kW	
Lid opening Ø	Ø100 mm			
Connection fluid in-/outlet	ISO RC 1/2" (english system 1/2") thread, stainless steel			
Pump power, lift height, m	max. flow rate	20 l/min.	30 l/min.	
	max. pressure & lift	1.0 bar, max. lift: 8 m	3.3 bar, max. lift: 27 m	
Cooling capacity	at +20°C	1.7 kW	2.8 kW	6.5 kW
	at 0°C	0.87 kW	1.3 kW	3.0 kW
	at -20°C	0.32 kW	0.45 kW	1.2 kW
External Dimensions	450 x 630 x 650 mm	550 x 830 x 975 mm	605 x 975 x 1265 mm	
Material	internal stainless steel, external powder-coated steel			
Power supply	1 Phase AC 230V, 50/60 Hz or 3 Phase 400V			
Order number 230V	DH.CHI0020	DH.CHI0030	-	
Order number 3 Phase	-	-	DH.CHI0050	

Circulator | external | refrigerated & heated

-30°C - +200°C, precise, refrigerated, heated, external, big filling volumina 10 l/18 l/25 l

WHR **NEW**

Ideal for:

- temperature control system for 5 – 100 l different reactors, evaporators and viscometer

Features:

- built-in, external nozzle for prevention of nozzle damage
- internal bath made from stainless steel (prevents corrosion)
- safety connection ports for connection with pipe for fluid in- and respectively outlet, made from stainless steel
- use with external direct contact K-temperature probe (optional)
- pump for internal and external circulation, max. 4 bar, max. flow rate 20-/40-/60 l/min
- 3 independent systems: refrigerating-, heating- and pre-cooling system
- faster heat-up and cool-down time
- high quality, shock-proof casters for convenient and safe moving
- CE certified and unique serial number for tracing

Safety mechanism:

- warning function and automatic stop function in case of liquid shortage

Controller:

- digital fuzzy control with Jog-Dial



Model	WHR-20	WHR-50	WHR-100
Temperature range & -stability	-30°C - +200°C, ±0.2°C at 15°C		
Filling volume heating fluid	max. 10 l	max. 18 l	max. 25 l
For XX l reactors, etc.	for 5 - 20 l reactors, etc.	for 20 - 50 l reactors, etc.	for 50 - 100 l reactors, etc.
Refrigerator capacity (HP)	4.5 kW	7.5 kW	18 kW
Heater	2.5 kW	6.0 kW	12 kW
Lid opening Ø	Ø80 mm		
Connection fluid in-/outlet	ISO RC 1" (english system AG 1") thread, stainless steel		
Pump power, lift height, m	max. flow rate	20 l/min.	40 l/min.
	max. pressure & lift	max. 4 bar, max. lift: 38 m	
Cooling capacity	at +15°C	8.1 kW	13.1 kW
	at 0°C	4.3 kW	7.3 kW
	at -25°C	1.4 kW	3.1 kW
External Dimensions	550 x 630 x 1060 mm	700 x 790 x 1270 mm	770 x 1100 x 1500 mm
Optional temperature sensor	external, direct K-temperature probe		
Material	internal stainless steel, external powder-coated steel, urethane foam insulation		
Power supply	1 Phase AC 230V, 50/60 Hz or 3 Phase 400V		
Order number 230V	DH.WHR0020	-	-
Order number 3 Phase	-	DH.WHR0050	DH.WHR0100

Filter Ø25mm, 15ml glass filter holder

Ideal for:

- small volume vacuum filtration for biological or particulate contamination analysis



VF5 - silicone stopper



VF8 - silicone stopper
with stainless steel support screen and PTFE gasket

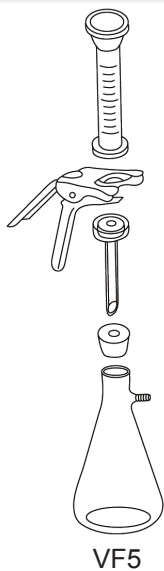

- 1
- 2
- 3
- 4
- 5

VF5 - 15ml funnel					
#	Item	Material	Size	Order number	
	25mm Glass microanalysis filtration set, complete				00829 167200-05
	25mm Glass microanalysis filtration set, filter holder				00829 167120-32
	Filter holder	Borosilicate glass	Ø25mm		
1	Funnel	Borosilicate glass	15 ml	00829 167220-15	
2	Clamp	Anodized aluminium		00829 167240-05	
3	Support base	Borosilicate glass		00829 167230-04	
4	Stopper	Silicone	No. 5	00829 167110-05	
5	Receiver flask	Borosilicate glass	125 ml	00829 167250-05	

VF8 - 15ml funnel with support screen					
#	Item	Material	Size	Order number	
	25mm Glass microanalysis filtration set, complete				00829 167200-08
	25mm Glass microanalysis filtration set, filter holder				00829 167120-34
	Filter holder	Borosilicate glass	Ø25mm		
1	Funnel	Borosilicate glass	15 ml	00829 167220-15	
2	Clamp	Anodized aluminium		00829 167240-05	
3	Support screen	Stainless steel		00829 167230-32	
4	Gasket	PTFE		00829 167230-42	
5	Support base	Borosilicate glass		00829 167230-08	
6	Stopper	Silicone	No. 5	00829 167110-05	
7	Receiver flask	Borosilicate glass	125 ml	00829 167250-05	

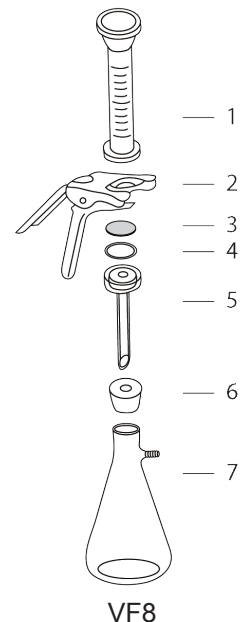

- 1
- 2
- 3
- 4
- 5
- 6
- 7

VF8

Filter Ø47mm, 300ml glass filter holder

Ideal for:

- solvent purification and general filtration for microbiology, suspended solid analysis etc.



VF6 - silicone stopper



VF7 - silicone stopper
with stainless steel support screen and PTFE gasket

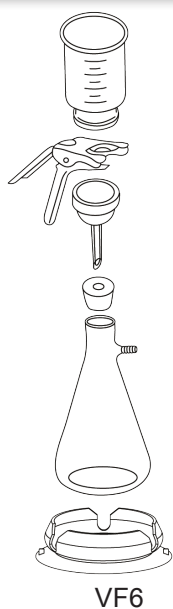

VF6

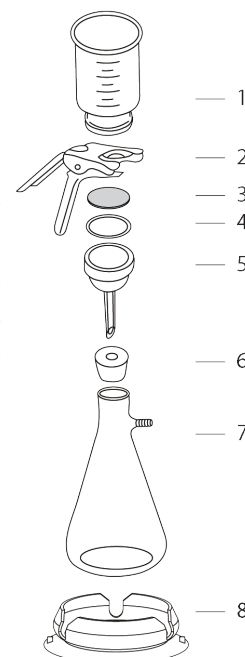

VF7

VF6 - 300ml funnel

#	Item	Material	Size	Order number
47mm Glass filtration set, complete				00829 167200-06
47mm Glass filtration set, filter holder				00829 167120-31
1	Filter holder	Borosilicate glass	Ø47mm	
2	Funnel	Borosilicate glass	300 ml	00829 167210-03
3	Clamp	Anodized aluminium		00829 167240-01
4	Support base	Borosilicate glass		00829 167230-03
5	Stopper	Silicone	No. 8	00829 167110-16
6	Receiver flask	Borosilicate glass	1000 ml	00829 167250-03
	Fixing sucker	Silicone		00829 167200-45

VF7 - 300ml funnel with support screen

#	Item	Material	Size	Order number
47mm Glass filtration set, complete				00829 167200-07
47mm Glass filtration set, filter holder				00829 167120-33
1	Filter holder	Borosilicate glass	Ø47mm	
2	Funnel	Borosilicate glass	300 ml	00829 167210-03
3	Clamp	Anodized aluminium		00829 167240-01
4	Support screen	Stainless steel		00829 167230-31
5	Gasket	PTFE		00829 167230-41
6	Support base	Borosilicate glass		00829 167230-07
7	Stopper	Silicone	No. 8	00829 167110-16
8	Receiver flask	Borosilicate glass	1000 ml	00829 167250-03
	Fixing sucker	Silicone		00829 167200-45

Filtration | glass

Filter Ø47mm / Ø90mm, 300ml / 1000ml glass filter holder

Ideal for:

- purification of organic, corrosive liquid such as solvent (mobile phase) for HPLC analysis



VF3 - ground joint socket
Ø47mm, 300ml



VF10 - ground joint socket
Ø90mm, 1000ml

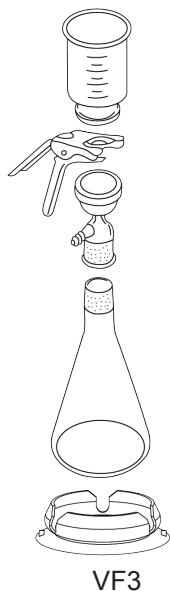

VF3

VF3 - 300ml funnel					
#	Item	Material	Size	Order number	
	47mm Glass filtration set, complete				00829 167200-03
	47mm Glass filtration set, filter holder				00829 167120-30
	Filter holder	Borosilicate glass	Ø47mm		
1	Funnel	Borosilicate glass	300 ml	00829 167210-03	
2	Clamp	Anodized aluminium		00829 167240-01	
3	Suction cap	Borosilicate glass		00829 167230-01	
4	Receiver flask	Borosilicate glass	1000 ml	00829 167250-01	
5	Fixing sucker	Silicone		00829 167200-45	

VF10 - 1000ml funnel					
#	Item	Material	Size	Order number	
	90mm Glass filtration set, complete				00829 167200-10
	90mm Glass filtration set, filter holder				00829 167120-35
	Filter holder	Borosilicate glass	Ø90mm		
1	Funnel	Borosilicate glass	1000 ml	00829 167210-10	
2	Clamp	Anodized aluminium		00829 167240-02	
3	Support screen	PTFE coated		00829 167230-33	
4	Gasket	PTFE		00829 167230-43	
5	Suction cap	Borosilicate glass		00829 167230-09	
6	Receiver flask	Borosilicate glass	4000 ml	00829 167250-06	

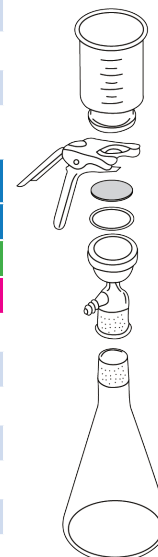

VF10

Filtration | stainless steel

Filter Ø47mm, 100ml / 500ml stainless steel filter holder

Ideal for:

- filtration requiring the sterilization such as microbiology test or use for purification of corrosive liquid, solvent, etc.



VF2 - silicone stopper
Ø47mm, 100ml



VF11 - silicone stopper
Ø47mm, 500ml

SPIN-LOCK CONNECTIONS

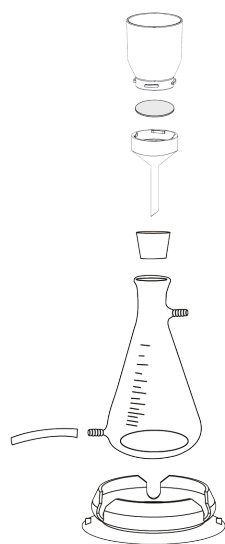

VF2

VF2 - 100ml funnel						
#	Item	Material	Size	Order number		
	47mm Stainless steel filtration set, complete				00829 167200-02	
	47mm Stainless steel filtration set, filter holder				00829 167103-10	
	Filter holder	Stainless steel	Ø47mm			
1	Funnel	Stainless steel	100 ml	00829 167103-61		
2	Support screen	Stainless steel		00829 167100-31		
3	Support base	Stainless steel		00829 167103-60		
4	Stopper	Silicone	No. 16	00829 167110-17		
5	Receiver flask	Borosilicate glass	1000 ml	00829 167300-08		
6	Fixing sucker	Silicone		00829 167200-45		

VF11 - 500ml funnel						
#	Item	Material	Size	Order number		
	47mm Stainless steel filtration set, complete				00829 167200-11	
	47mm Stainless steel filtration set, filter holder				00829 167103-50	
	Filter holder	Stainless steel	Ø47mm			
1	Funnel	Stainless steel	500 ml	00829 167103-65		
2	Support screen	Stainless steel		00829 167100-31		
3	Support base	Stainless steel		00829 167103-60		
4	Stopper	Silicone	No. 18	00829 167110-18		
5	Receiver flask	Borosilicate glass	2000 ml	00829 167200-13		

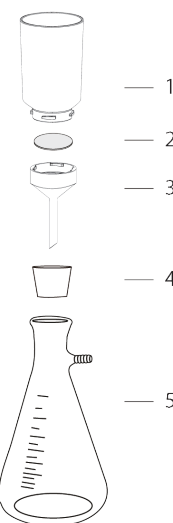

VF11

Filter Ø47mm, 300ml PES filter holder

Features:

- spin-lock connection facilitates fast and stable installation without clamp
- excellent smash and high temperature resistance
- autoclavable
- built-in overflow protection to keep the filtrate from overflowing when waste bottle is full
- funnel graduated in 50ml, receiver in 100ml increments for easy measurement

SPIN-LOCK CONNECTIONS



LF 30 - PC receiver flask
Ø47mm, 300ml



LF 31 - Borosilicate glass receiver flask
Ø47mm, 300ml

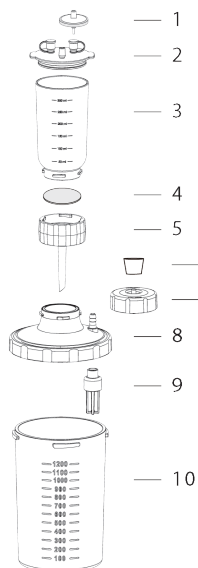

LF 30

LF 30 - PC receiver flask					
#	Item	Material	Size	Order number	
	47mm PES filtration set, complete				00829 197010-30
	47mm PES filtration set, filter holder				00829 197000-01
1	Filter	PES	Ø47mm		
2	Syringe filter	PTFE	25mm,02µm	00829 194225-01	
3	Lid kit	PP		00829 197000-36	
4	Funnel	PES	300 ml	00829 197000-34	
5	Support screen	PP		00829 197000-37	
6	Support base	PC		00829 197000-35	
7	Stopper	Silicone	No. 16	00829 167110-17	
	PC Waste bottle with cover				00829 197000-11-PC
8	Cap	PP		00829 197000-40	
9	Cover	PC		00829 197000-32-PC	
10	Overflow protection			00829 197000-39	
	Waste bottle	PC	1200 ml	00829 197000-31-PC	

LF 31 - borosilicate glass receiver flask					
#	Item	Material	Size	Order number	
	47mm PES filtration set, complete				00829 197010-31
	47mm PES filtration set, filter holder				00829 197000-01
1	Filter	PES	Ø47mm		
2	Syringe filter	PTFE	25mm,02µm	00829 194225-01	
3	Lid kit	PP		00829 197000-36	
4	Funnel	PES	300 ml	00829 197000-34	
5	Support screen	PP		00829 197000-37	
6	Support base	PC		00829 197000-35	
7	Stopper	Silicone	No. 16	00829 167110-17	
8	Receiver flask	Borosilicate glass	1000 ml	00829 167300-08	
	Fixing sucker	Silicone		00829 167200-45	

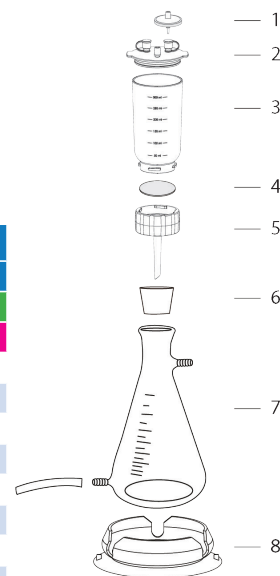

LF 31

Filter Ø47mm, 100ml / 300ml stainless steel filter holder

Features:

- spin-lock connection facilitates fast and stable installation without clamp
- stainless steel funnel offers excellent chemical resistance and can be sterilized
- built-in overflow protection to keep the filtrate from overflowing when waste bottle is full



LF 32 - PC receiver flask
Ø47mm, 100ml

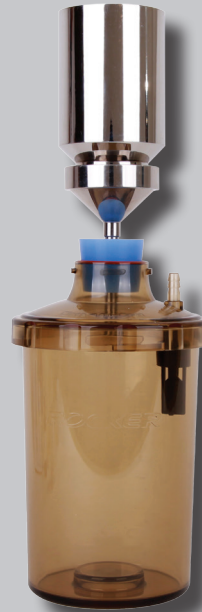

LF 33 - PC receiver flask
Ø47mm, 300ml

SPIN-LOCK CONNECTIONS

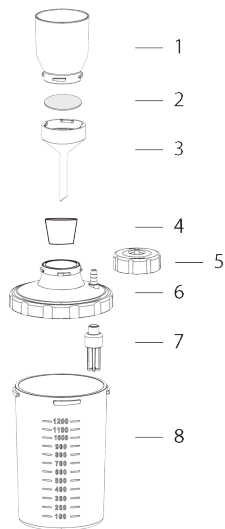

LF 32

LF 32 - 100ml funnel					
#	Item	Material	Size	Order number	
	47mm stainless steel filtration set, complete				00829 197010-32
	47mm stainless steel filtration set, filter holder				00829 167103-10
1	Filter	Stainless steel	Ø47mm		
2	Funnel	Stainless steel	100 ml	00829 167103-61	
3	Support screen	Stainless steel		00829 167100-31	
4	Support base	Stainless steel		00829 167103-60	
5	Stopper	Silicone	No. 16	00829 167110-17	
	PC Waste bottle with cover				00829 197000-11-PC
6	Cap	PP		00829 197000-40	
7	Cover	PC		00829 197000-32-PC	
8	Overflow protection			00829 197000-39	
	Waste bottle	PC	1200 ml	00829 197000-31-PC	

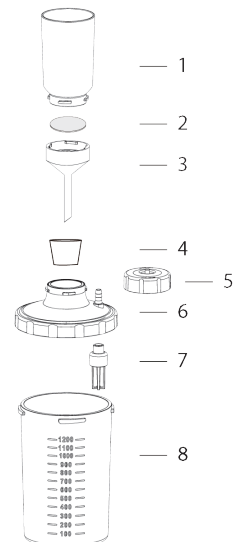

LF 33

LF 33 - 300ml funnel					
#	Item	Material	Size	Order number	
	47mm stainless steel filtration set, complete				00829 197010-33
	47mm stainless steel filtration set, filter holder				00829 167103-30
1	Filter	Stainless steel	Ø47mm		
2	Funnel	Stainless steel	300 ml	00829 167103-63	
3	Support screen	Stainless steel		00829 167100-31	
4	Support base	Stainless steel		00829 167103-60	
5	Stopper	Silicone	No. 16	00829 167110-17	
	PC Waste bottle with cover				00829 197000-11-PC
6	Cap	PP		00829 197000-40	
7	Cover	PC		00829 197000-32-PC	
8	Overflow protection			00829 197000-39	
	Waste bottle	PC	1200 ml	00829 197000-31-PC	

Filter holder | PES

Filter Ø47mm, 300ml / 500ml PES filter holder

Features:

- spin-lock connection facilitates fast and stable installation without clamp
- PES structure offers excellent smash and high temperature resistance (up to 180°C)
- autoclavable
- reusable
- funnel graduated in 50ml increments for easy measurement



LF 3 - 300ml
Ø47mm, with stopper



LF 5 - 500ml
Ø47mm, with stopper



LF 3a - 300ml
Ø47mm, with bottle adaptor



LF 5a - 500ml
Ø47mm, with bottle adaptor

SPIN-LOCK CONNECTIONS

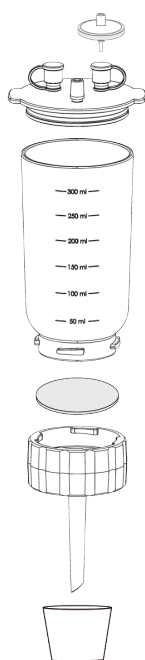

LF 3 / 5

LF 3 / 5 with stopper

#	Item	Material	Size	Order number
	300ml, 47mm PES filter holder, complete			00829 197000-01
	500ml, 47mm PES filter holder*			00829 197000-03
1	Syringe filter	PTFE	25mm, 0.2µm	00829 194225-01
2	Lid kit LF 3	PP, Silicone		00829 197000-36
2	Lid kit LF 5	PP, Silicone		00829 200300-36
3	Funnel LF 3	PES	300 ml	00829 197000-34
3	Funnel LF 5	PES	500 ml	00829 197000-56
4	Support screen	PP		00829 197000-37
5	Support base	PC		00829 197000-35
6	Stopper	Silicone	No. 16	00829 167110-17

* lid kit for LF 5 not included, please order separately

LF 3a / 5a with bottle adaptor

#	Item	Material	Size	Order number
	300ml, 47mm PES filter holder, complete			00829 197000-02
	500ml, 47mm PES filter holder*			00829 197000-04
1	Syringe filter	PTFE	25mm, 0.2µm	00829 194225-01
2	Lid kit LF 3a	PP, Silicone		00829 197000-36
2	Lid kit LF 5a	PP, Silicone		00829 200300-36
3	Funnel LF 3a	PES	300 ml	00829 197000-34
3	Funnel LF 5a	PES	500 ml	00829 197000-56
4	Support screen	PP		00829 197000-37
5	Bottle adaptor	Tissue	GL 45	00829 197000-38

* lid kit for LF 5a not included, please order separately

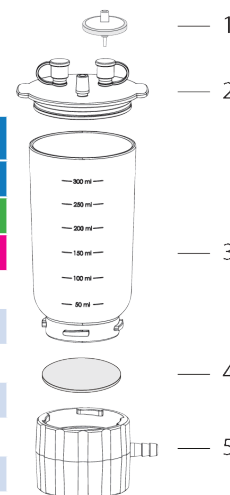

LF 3a / 5a

Filter Ø47mm, 300ml / 500ml magnetic PES filter holder

Features:

- magnetic connection facilitates fast and stable installation without clamp
- strong magnetic seal allows one-handed operation, prevents possible twisting and tearing of the membrane
- membrane guide on the base helps positioning membrane easily
- PES structure offers excellent smash and high temperature resistance (up to 180°C)
- autoclavable
- reusable
- funnel graduated in 50ml increments for easy measurement

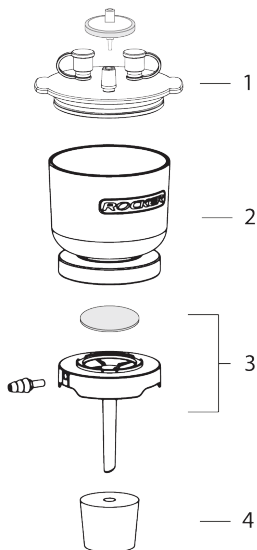

MF 3 / 5

MF 3 / 5 magnetic PES filter holder, stopper, long stem

#	Item	Material	Size	Order number
	300ml, 47mm magnetic PES filter holder, complete			00829 200300-01
	500ml, 47mm magnetic PES filter holder, complete			00829 200500-01
1	Lid kit	PP		00829 200300-36
2	Funnel	PES	300 ml 500 ml	00829 200300-30 00829 200500-30
3	Support base	PES	long stem	00829 200300-32
4	Stopper	Silicone	No. 8	00829 167110-16

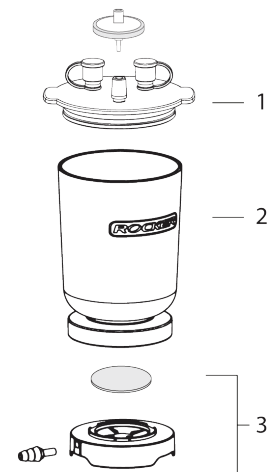

MF 3a / 5a

MF 3a / 5a magnetic PES filter holder, short stem

#	Item	Material	Size	Order number
	300ml, 47mm magnetic PES filter holder, complete			00829 200310-01
	500ml, 47mm magnetic PES filter holder, complete			00829 200510-01
1	Lid kit	PP		00829 200300-36
2	Funnel	PES	300 ml 500 ml	00829 200300-30 00829 200500-30
3	Support base	PP	short stem	00829 200310-32

Filter holder | stainless steel

Filter Ø47mm, 100ml - 500ml stainless steel filter holder

Features:

- spin-lock connection facilitates fast and stable installation without clamp
- stainless steel funnel offers excellent chemical resistance and can be sterilized

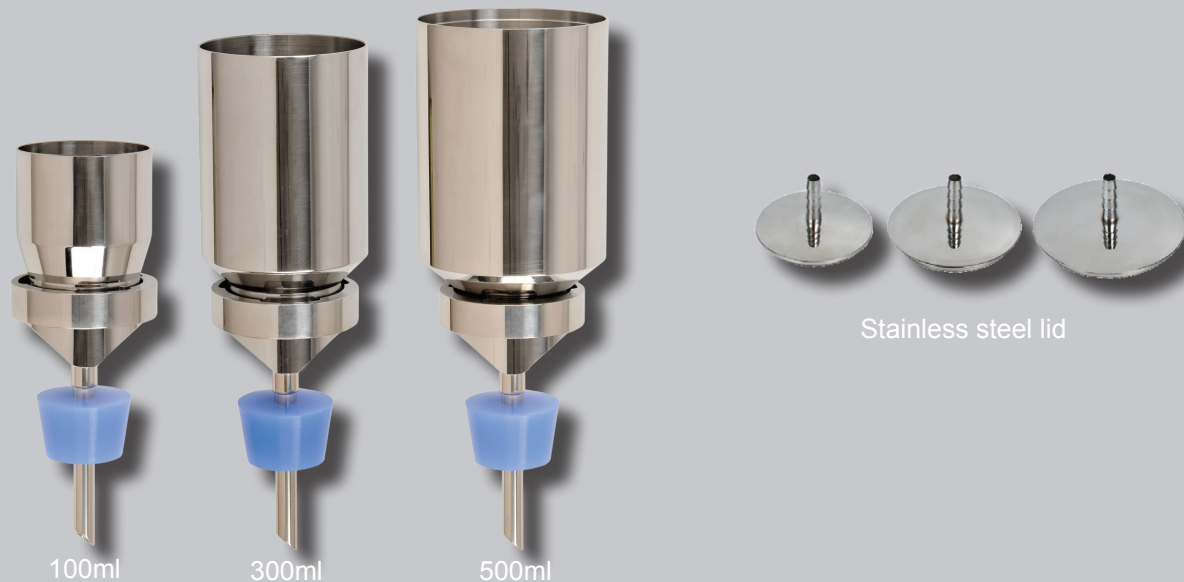

SPIN-LOCK CONNECTIONS

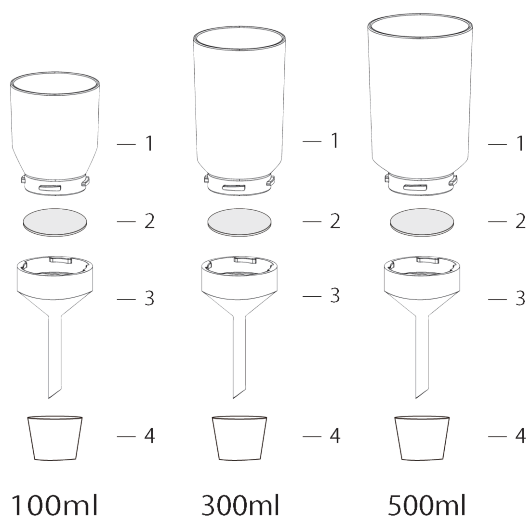

100ml / 300ml / 500ml stainless steel filter holder				
#	Item	Material	Size	Order number
	100ml, 47mm stainless steel filter holder, complete			00829 167103-10
	300ml, 47mm stainless steel filter holder, complete			00829 167103-30
	500ml, 47mm stainless steel filter holder, complete			00829 167103-50
1	Funnel	Stainless steel	100 ml 300 ml 500 ml	00829 167103-61 00829 167103-63 00829 167103-65
2	Support screen	Stainless steel		00829 167100-31
3	Support base	Stainless steel		00829 167103-60
4	Stopper	Silicone	No. 16 (100/300ml) No. 18 (500ml)	00829 167110-17 00829 167110-18

Stainless steel lids for filter holder	
Item	Order number
Stainless steel lid for 100ml filter holder	00829 167103-11
Stainless steel lid for 300ml filter holder	00829 167103-13
Stainless steel lid for 500ml filter holder	00829 167103-15

Filter holder filtration set



Model	Rocker 300 & LF30	
Scope of supply	oil free vacuum pump Rocker 300 filtration set LF30 silicone tube (1m)	
Pump	120V (23 l/min, 106 mbar)	230V (20 l/min, 106 mbar)
Filtration set	300 ml PES funnel LF30 1200 ml PC waste bottle overflow protection spin-lock connections	
Ideal for	general filtration in laboratories suspended solid test microbiological tests	
Order number 120V	00829 167305-11	-
Order number 230V	-	00829 167305-22



Model	Rocker 300 & MF31	
Scope of supply	oil free vacuum pump Rocker 300 filtration set MF31 silicone tube (1m)	
Pump	120V (23 l/min, 106 mbar)	230V (20 l/min, 106 mbar)
Filtration set	300 ml PES funnel MF31 1000 ml glass receiving flask with drain magnetic connections	
Ideal for	general filtration in laboratories suspended solid test microbiological tests	
Order number 120V	00829 167311-11	-
Order number 230V	-	00829 167311-22



Model	Rocker 300 C & VF12	
Scope of supply	oil free / chemical-resistant vacuum pump Rocker 300 C filtration set VF12 silicone tube (1m)	
Pump	120V (23 l/min, 173 mbar)	230V (20 l/min, 173 mbar)
Filtration set	300 ml glass funnel VF12 1000 ml glass receiving flask GL 45 aluminium clamp connection	
Ideal for	purification of organic, corrosive liquids such as solvent (mobile phase) for HPLC analysis	
Order number 120V	00829 189302-11	-
Order number 230V	-	00829 189302-22



Model	Chemker 300 & VF12	
Scope of supply	chemical-resistant vacuum pump Chemker 300 filtration set VF12 silicone tube (1m)	
Pump	120V (20 l/min, 120 mbar)	230V (18 l/min, 120 mbar)
Filtration set	300 ml glass funnel VF12 1000 ml glass receiving flask GL 45 aluminium clamp connection	
Ideal for	purification of organic, corrosive liquids such as solvent (mobile phase) for HPLC analysis	
Order number 120V	00829 169302-11	-
Order number 230V	-	00829 169302-22

Vacuum filtration system

Lafil 400, -135 mmHg, up to 25 l/min

Ideal for:

- filtration for microbiology tests
- suspended solid tests
- general laboratory filtration
- vacuum filtration
- cell culture aspiration
- laboratory waste suction

Features:

- -135 mmHg
- up to 25 l/min
- combines vacuum source with filtration accessories
- compact design
- different sets available
- CE certified



Lafil 400

Model	Lafil 400	
Max. power (W)	100	80
Max. current (A)	1.0	0.4
Max. vacuum	33 mbar	
Max. flow rate	25 l/min	22 l/min
Motor rotation	1750 rpm	1450 rpm
Port thread	5/16 inch (8 mm)	
Dimension (LxWxH)	33.5 x 23 x 45 cm	
Power supply	1 Phase AC 120V, 60 Hz or AC 230V, 50/60 Hz	
Order number 120V	00829 197400-11	-
Order number 230V	-	00829 197400-22

Different waste bottles can be found on page 196
Available sets see on next page

Vacuum filtration system sets

Lafil 400 - LF 30

Specification	Lafil 400 120V / 60Hz	Lafil 400 230V / 50Hz
Filter funnel	PES (300 ml, Ø47 mm)	
Waste bottle	PC (1200 ml)	
Funnel support base	PC	
Funnel lid	PP (containing PTFE syringe filter 25 mm, 0.2 µm)	
Overflow protection	PP	
Order number 120V	00829 197401-11	-
Order number 230V	-	00829 197401-22



Lafil 400 - LF 32

Specification	Lafil 400 120V / 60Hz	Lafil 400 230V / 50Hz
Filter funnel	Stainless steel SS316 (100 ml, Ø47 mm)	
Waste bottle	PC (1200 ml)	
Funnel support base	Stainless steel SS316	
Overflow protection	PP	
Order number 120V	00829 197402-11	-
Order number 230V	-	00829 197402-22



Lafil 400 - LF 5a

Specification	Lafil 400 120V / 60Hz	Lafil 400 230V / 50Hz
Filter funnel	PES (500 ml)	
Tissue bottle	Borosilicate glass (500 ml)	
Funnel support base	PC	
Order number 120V	00829 197404-11	-
Order number 230V	-	00829 197404-22



Lafil 400 plus

Specification	Lafil 400 120V / 60Hz	Lafil 400 230V / 50Hz
Suction bottle	PC (1200 ml)	
1-channel tip adaptor with ejector	POM	
8-channel tip adaptor with ejector	POM	
1-channel tip adaptor (150 mm)	POM	
Order number 120V	00829 197405-11	-
Order number 230V	-	00829 197405-22



Microplate manifold

WelVac 200



WelVac 200

Ideal for:

- DNA purification
- RNA purification
- gel purification
- PCR clean-up

Features:

- designed to replace traditional centrifuges with vacuum source to simplify purification process of:
 - plasmid DNA
 - single-stranded phage DNA, RNA
 - genomic DNA
 - viral nucleic acids from PCR
 - other enzymatic reactions
- rapid continuous sample purification without centrifugation
- multi-use due to different adapter boards
- compatible with various kinds of centrifuge tubes and 96 well micro filter plates



WelVac 200
with large volume centrifuge tubes

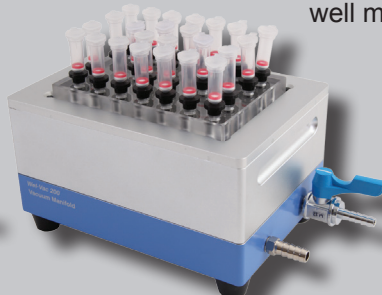

WelVac 200
with micro centrifuge tubes



WelVac 200
with 96 well micro filter plate

Model	WelVac 200
Vacuum manifold material	Anodized aluminium
Gasket material	Rubber
O-ring material	Rubber
Column adapter board material	PC
Luer connector material	Silicone rubber
Luer stopper material	Silicone rubber
Port thread	5/16 inch (8mm)
Manifold internal dim. (LxWxH)	12.8 x 8.6 x 7.3 cm
Manifold external dim. (LxWxH)	23.3 x 12.4 x 10.2 cm
Net weight	2.6 kg
Order number	00829 195200-00

WelVac 200 will be delivered with:

- vacuum manifold base
- vacuum manifold spacer
- vacuum manifold waste tray
- spin column adapter board (24 holes)
- Luer connectors (25 pieces)
- Luer stopper (25 pieces)
- spare gasket and O-ring
- Allen key

Filtration set:

Model	Rocker 300 & WelVac 200	
Scope of supply	oil free vacuum pump Rocker 300 microplate vacuum manifold WelVac 200 disc filter silicone tube (30 cm)	
Pump	120V (23 l/min, -680 mmHg)	230V (20 l/min, -680 mmHg)
Manifold	WelVac 200 set	
Ideal for	DNA purification RNA purification gel purification PCR clean up	
Order number 120V	00829 195210-11	-
Order number 230V	-	00829 195210-22



Rocker 300 & WelVac 200

Manifold with stopper

MultiVac 310-MS

Ideal for:

- filtration for microbiology tests
- chemistry experiments
- general laboratory filtration

Features:

- MultiVac 310-MS is made of anodized aluminium
- includes 3x silicone stopper No. 8 to fit various types of filter holder
- each branch permits individual control
- quick-fit hose barb can be connected to both sides



MultiVac 310-MS

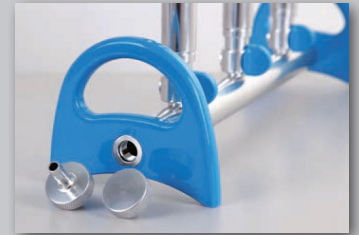

Example use

Model	MultiVac 310-MS	MultiVac 610-MS
Number of branches	3	6
Port thread	5/16 inch (8mm)	5/16 inch (8mm)
Dimensions (LxWxH)	47 x 13 x 16 cm	47 x 13 x 16 cm
Parts		
Body	Anodized aluminium	Anodized aluminium
Control valve	Anodized aluminium	Anodized aluminium
Handle	Anodized aluminium	Anodized aluminium
Hose barb	Anodized aluminium	Anodized aluminium
Order number	00829 180310-01	00829 180610-01

Suitable filter holder:

Model	Filter Ø	Connection	Material	Page
VF5	25mm	stopper & clamp	glass	156
VF8	25mm	stopper & clamp	glass	156
VF7	47mm	stopper & clamp	glass	157
VF6	47mm	stopper & clamp	glass	157
VF2	47mm	stopper & spin-lock	stainless steel	159

Model	Filter Ø	Connection	Material	Page
VF11	47mm	stopper & spin-lock	stainless steel	159
LF32	47mm	stopper & spin-lock	stainless steel	161
LF33	47mm	stopper & spin-lock	stainless steel	161
LF3/5	47mm	stopper & spin-lock	PES	162
MF3/5	47mm	stopper & magnet	PES	163

Manifold with stopper

MultiVac 300-MS | MultiVac 600-MS

Ideal for:

- filtration for microbiology tests
- chemistry experiments
- general laboratory filtration

Features:

- MultiVac MS is made of anodized aluminium and stainless steel
- includes silicone stopper No. 8 to fit various types of filter holder
- each branch permits individual control
- adjustable vent valve design helps to drain residual liquid off the tube
- innovative vent valve design prevents from water hammer phenomenon
- quick-fit hose barb can be connected to both sides

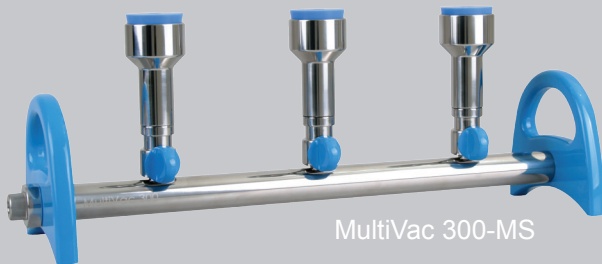

Model	MultiVac 300-MS	MultiVac 600-MS
Number of branches	3	6
Filter diameter	47mm / 50mm	47mm / 50mm
Funnel capacity (possible)	100ml / 300ml / 500ml	100ml / 300ml / 500ml
Effective filtration area	9.6cm ²	9.6cm ²
Port thread	5/16 inch (8mm)	5/16 inch (8mm)
Dimensions (LxWxH)	48 x 13 x 11 cm	85 x 13 x 11 cm
Parts	Material	Material
Body	Stainless steel SS316	Stainless steel SS316
Connector	Stainless steel SS316	Stainless steel SS316
Filter funnel	Stainless steel SS316	Stainless steel SS316
Funnel support base	Stainless steel SS316	Stainless steel SS316
Control valve & handle	Anodized aluminium	Anodized aluminium
Order number	00829 180300-01	00829 180600-01

Suitable filter holder:

Model	Filter Ø	Connection	Material	Page
VF5	25mm	stopper	glass	156
VF8	25mm	stopper	glass	156
VF7	47mm	stopper	glass	157
VF6	47mm	stopper	glass	157
VF2	47mm	stopper & spin-lock	stainless steel	159

Model	Filter Ø	Connection	Material	Page
VF11	47mm	stopper & spin-lock	stainless steel	159
LF32	47mm	stopper & spin-lock	stainless steel	161
LF33	47mm	stopper & spin-lock	stainless steel	161
LF3/5	47mm	stopper	PES	162
MF3/5	47mm	stopper	PES	163

Manifold with spin-lock

MultiVac 300-MB | MultiVac 600-MB

Ideal for:

- filtration for microbiology tests
- chemistry experiments
- general laboratory filtration

Features:

- MultiVac MB is made of anodized aluminium and stainless steel
- compatible with different sizes of funnels
- each branch permits individual control
- adjustable vent valve design helps to drain residual liquid off the tube
- innovative vent valve design prevents from water hammer phenomenon
- quick-fit hose barb can be connected to both sides



MultiVac 300-MB

SPIN-LOCK CONNECTIONS



MultiVac 600-MB

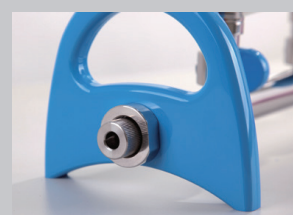

adjustable vent valve



quick-fit hose barb

Model	MultiVac 300-MB	MultiVac 600-MB
Number of branches	3	6
Filter diameter	47mm / 50mm	47mm / 50mm
Funnel capacity (possible)	100ml / 300ml / 500ml	100ml / 300ml / 500ml
Effective filtration area	9.6cm ²	9.6cm ²
Port thread	5/16 inch (8mm)	5/16 inch (8mm)
Dimensions (LxWxH)	48 x 13 x 11 cm	85 x 13 x 11 cm
Parts	Material	Material
Body	Stainless steel SS316	Stainless steel SS316
Connector	Stainless steel SS316	Stainless steel SS316
Filter funnel	Stainless steel SS316	Stainless steel SS316
Funnel support base	Stainless steel SS316	Stainless steel SS316
Control valve & handle	Anodized aluminium	Anodized aluminium
Order number	00829 180300-02	00829 180600-02

Suitable funnels:



Model	Filter Ø	Connection	Material	Order number	Page
100ml	47mm	spin-lock	stainless steel	00829 167103-61	164
300ml	47mm	spin-lock	stainless steel	00829 167103-63	
500ml	47mm	spin-lock	stainless steel	00829 167103-65	

Manifold filtration set

Model	MultiVac 310-MS-T	
Scope of supply	oil free vacuum pump Rocker 400 anodized aluminium manifold MultiVac 310-MS, 3 places with stopper 3x magnetic PES filter holder 300 ml waste bottle PP 4000 ml silicone tube (2m)	
Pump	120V (37 l/min, -670 mmHg)	230V (34 l/min, -670 mmHg)
Filtration set	300 ml PES funnel with magnetic connections	
Ideal for	filtration for suspended solid test filtration for microbiology test general laboratory filtration	
Order number 120V	00829 180311-11-T	-
Order number 230V	-	00829 180311-22-T

**3-places manifold
300 ml PES filter holder**



Model	MultiVac 300-MB-T	
Scope of supply	oil free vacuum pump Rocker 400 manifold MultiVac 300-MB, 3 places spin-lock 3x stainless steel filter funnel 100 ml waste bottle PP 4000 ml torch burner MCE membrane, 47 mm, 0.45µm, 200 pcs./PK silicone tube (2m)	
Pump	120V (37 l/min, -680 mmHg)	230V (34 l/min, -680 mmHg)
Filtration set	100 ml stainless steel funnel spin-lock connections	
Ideal for	filtration for microbiology test chemical experiments general laboratory filtration	
Order number 120V	00829 180300-11-T	-
Order number 230V	-	00829 180300-22-T

**3-places manifold
100 ml stainless steel funnels**



Model	MultiVac 600-MB-T	
Scope of supply	oil free vacuum pump Rocker 400 manifold MultiVac 600-MB, 6 places spin-lock 6x stainless steel filter funnel 100 ml waste bottle PP 4000 ml torch burner MCE membrane, 47 mm, 0.45µm, 200 pcs./PK silicone tube (2m)	
Pump	120V (37 l/min, -680 mmHg)	230V (34 l/min, -680 mmHg)
Filtration set	100 ml stainless steel funnel spin-lock connections	
Ideal for	filtration for microbiology test chemical experiments general laboratory filtration	
Order number 120V	00829 180600-11-T	-
Order number 230V	-	00829 180600-22-T

**6-places manifold
100 ml stainless steel funnels**

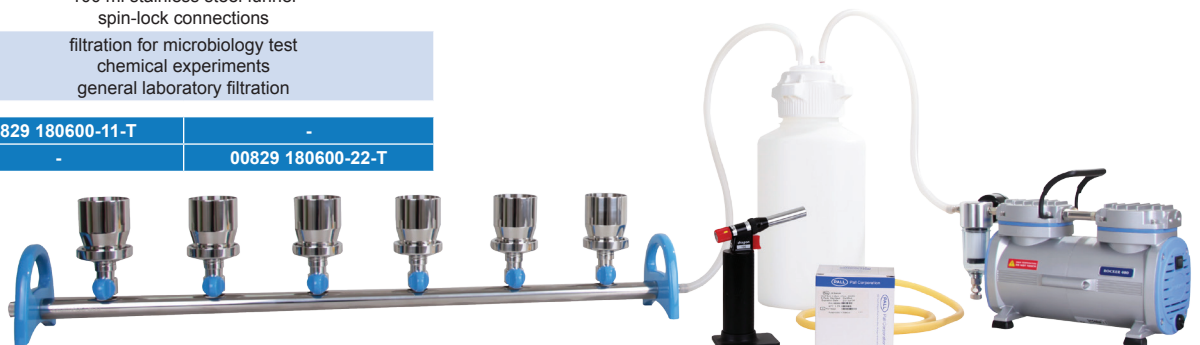

Portable suction system

BioVac 225 / 240, up to -720 mmHg, up to 40 l/min

Ideal for:

- cell culture aspiration
- laboratory waste suction

Features:

- up to -720 mmHg
- up to 40 l/min
- diaphragm (BioVac 225) or piston (BioVac 240) pump
- overflow protection in suction bottle
- 0.2 µm PTFE hydrophobic disc filter between suction bottle and pump prevents medium from flowing into the pump
- oil free, maintenance free, low noise
- fittings and suction bottle autoclavable
- CE certified

BioVac 225



BioVac 240 Plus



Model	BioVac 225		BioVac 240	
Max. vacuum	-680 mmHg		-720 mmHg	
Max. flow rate	25 l/min	23 l/min	40 l/min	38 l/min
Port thread	3/16 inch (5 mm)		3/16 inch (5 mm)	
Thermal protector	Yes		Yes	
Pump type	Diaphragm		Piston	
Dimension (LxWxH)	37 x 15 x 25 cm		53 x 24 x 35 cm	
Suction bottle	PC (1000 ml)		PC (3000 ml)	
Power supply	1 Phase AC 120V, 60 Hz or AC 230V, 50/60 Hz			
Order number standard 120V	00829 167225-11	-	00829 167240-11	-
Order number standard 230V	-	00829 167225-22	-	00829 167240-22
Order number plus 120V	00829 167227-11	-	00829 167241-11	-
Order number plus 230V	-	00829 167227-22	-	00829 167241-22

Scope of supply:

BioVac standard will be delivered with 1-channel tip adaptor (150 mm)

BioVac Plus will be delivered with handle, 1-channel tip adaptor with ejector (POM), 8-channel tip adaptor with ejector (POM) and 1-channel tip adaptor (150 mm)

Model	Material	separate order number
Handle grip	POM	00829 199100-30
1-Channel tip adaptor (150 mm)	POM	00829 199100-76
8-Channel tip adaptor with ejector	POM	00829 199100-50
1-Channel tip adaptor with ejector	POM	00829 199100-75

Details on page 173

Portable suction system

Lafil 100, -500 mmHg, 1 l/min

Ideal for:

- cell culture aspiration
- laboratory waste suction

Features:

- -500 mmHg
- 1 l/min
- dual function system: suction and filtration
- ideal for operation in laminar flow
- all fittings are made of POM (autoclavable)
- CE certified



Lafil 100 with tissue bottle and suction cap

Model	Lafil 100	
Max. vacuum	-500 mmHg	
Max. flow rate	1.0 l/min	
Motor	DC brushless motor	
Net weight	1.3 kg	
Dimension (LxWxH)	26.5 x 13 x 21 cm	
Material	Case: ABS Handle: POM Channel tip adaptor: POM GL 45 suction cap: PP Bottle: Borosilicate glass	
Tissue bottle included	500 ml with GL 45 suction cap	
Power supply	DC 12V / AC100-240V	
Order number EU plug	00829 197100-02	-
Order number US plug	-	00829 197100-01

Suitable filter holder can be found on next page - other suitable filter holder can be found on page 162, 163 and 164.

Scope of supply:

Lafil 100 will be delivered with handle, 1-channel tip adaptor, 8-channel tip adaptor and Tissue bottle with suction cap



Portable suction system sets



Lafil 100 with LF 3A
300 ml PES filter holder



Lafil 100 with LF 5A
500 ml PES filter holder without lid kit

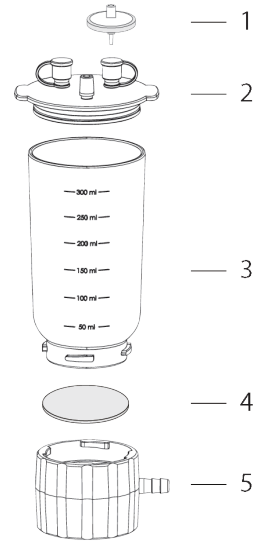

LF 3a / 5a

LF 3a / 5a with bottle adaptor				
#	Item	Material	Size	Order number
	300 ml, 47 mm PES filter holder, complete			00829 197000-02
	500 ml, 47 mm PES filter holder			00829 197000-04
1	Syringe filter	PTFE	25 mm, 0.2µm	00829 194225-01
2	Lid kit LF 3a	PP, Silicone		00829 197000-36
2	Lid kit LF 5a	PP, Silicone		00829 200300-36
3	Funnel LF 3a	PES	300 ml	00829 197000-34
3	Funnel LF 5a	PES	500 ml	00829 197000-56
4	Support screen	PP		00829 197000-37
5	Bottle adaptor			00829 197000-38

Suction cap - autoclavable

Specification	GL 45
Port thread (I.D. tubing)	3/16 inch (5 mm)
Material	PP
Order number blue	00829 197000-60



500 ml tissue bottle with cap GL 45 and color-code graduation



Specification	500 ml
Thread	GL 45 with pouring ring
Material	Borosilicate glass
Order number white	5 526 500 B
Order number blue	5 526 500 BL
Order number yellow	5 526 500 GE
Order number green	5 526 500 GR
Order number red	5 526 500 RO

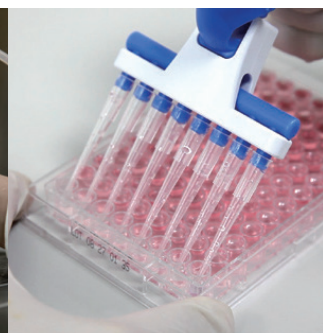

Universal suction kit

BioDolphin with different adaptors

Ideal for:

- cell culture aspiration
- laboratory waste suction

Features:

- user-friendly
- continuous suction without pressing the button
- quick connection between fitting and handle
- storage rack to keep order
- built-in liquid collecting tray
- autoclavable (except storage rack)



BioDolphin

Model	BioDolphin complete kit
Operation	Press to suck
Port thread	3/16 inch (5 mm)
Dimension (LxWxH)	15 x 15.2 x 14.5
Order number	00829 199100-00

Different waste bottles can be found on page 193
Vacuum pumps can be found from page 188 to 194

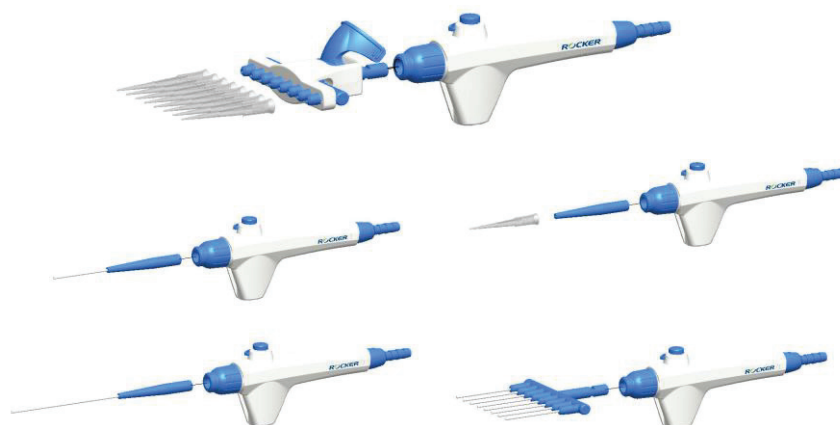

Universal suction kit

Complete kit contains following material:

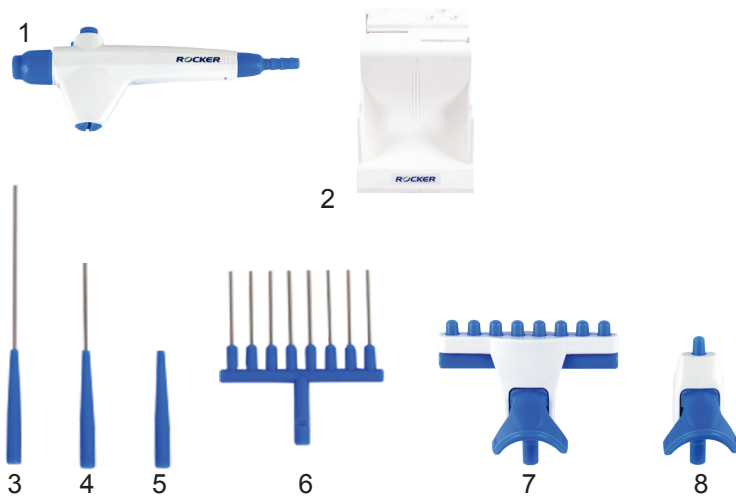

#	Model	Material	separate order number
1	Handle grip	POM	00829 199100-30
2	Rack		00829 199100-61
3	1-Channel adaptor (80 mm)	Stainless steel, POM	00829 199100-48
4	1-Channel adaptor (40 mm)	Stainless steel, POM	00829 199100-47
5	1-Channel tip adaptor	POM	00829 199100-46
6	8-Channel adaptor (40 mm)	Stainless steel, POM	00829 199100-49
7	8-Channel tip adaptor with ejector	POM	00829 199100-50
8	1-Channel tip adaptor with ejector	POM	00829 199100-75



Vacuum filtration system

WaterVac 100 integrated vacuum pump

Ideal for:

- microbiological filtration technique for analysing aqueous-based fluids for microbiological contamination
- suspended solid test for municipal, surface, ground and drinking water
- general filtration without the need of collecting filtrate

Features:

- -540 mmHg
- up to 0,5 l/min (liquid) or 2,2 l/min (air)
- integrated vacuum pump
- compact design - ideal for work benches or laminar flow hoods
- no special suction flask or waste bottle is needed
- available with spin-lock or stopper design
- one push-button for easy operation
- silicone tube (2m) for waste drain included



WaterVac 100 with stopper



WaterVac 100 with spin-lock

Model	WaterVac 100 stopper	WaterVac 100 spin-lock
Filter diameter	47mm / 50mm	
Max. flow rate	0.5 l/min (liquid) or 2.2 l/min (air)	
Max. vacuum	-540 mmHg	
Weight	1.16 kg	
Dimensions (LxWxH)	170 x 120 x 96 mm	
Parts	Material	
Housing	SUS 304	
Valve plate	EPDM (Ethylene Propylene Diene Monomer)	
Diaphragm	EPDM (Ethylene Propylene Diene Monomer)	
Inlet / outlet port	SUS 316	
O-ring / tube	FKM / silicone Ø4 x 8mm, 2m length	
Order number 100-240V EU-plug	00829 190110-02	00829 190120-02

Accessories: Suitable filter holder and funnels on next page

Vacuum filtration system

Filter Ø47mm, 100ml - 500ml stainless steel filter holder

- spin-lock connection facilitates fast and stable installation without clamp
- stainless steel funnel offers excellent chemical resistance and can be sterilized
- complete set can be used for WaterVac100 stopper and spin-lock design
- funnel only can be used for WaterVac 100 with spin-lock

100ml / 300ml / 500ml stainless steel filter holder

#	Item	Material	Size	Order number
#	100ml, 47mm stainless steel filter holder, complete			00829 167103-10
	300ml, 47mm stainless steel filter holder, complete			00829 167103-30
	500ml, 47mm stainless steel filter holder, complete			00829 167103-50
1	Funnel	Stainless steel SS316	100 ml 300 ml 500 ml	00829 167103-61 00829 167103-63 00829 167103-65
2	Support screen	Stainless steel SS316		00829 167100-31
3	Support base	Stainless steel SS316		00829 167103-60
4	Stopper	Silicone	No. 16 (100/300ml) No. 18 (500ml)	00829 167110-17 00829 167110-18

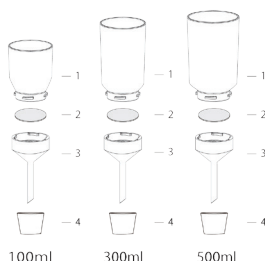

Filter Ø47mm, 300ml / 500ml magnetic PES filter holder MF 3/5

- magnetic connection facilitates fast and stable installation without clamp
- strong magnetic seal allows one-handed operation, prevents possible twisting and tearing of the membrane
- membrane guide on the base helps positioning membrane easily
- PES structure offers excellent smash and high temperature resistance (up to 180°C)
- autoclavable
- reusable
- funnel graduated in 50ml increments for easy measurement
- MF 3/5 can be used for WaterVac100 with stopper design

MF 3 / 5 magnetic PES filter holder, stopper, long stem

#	Item	Material	Size	Order number
#	300ml, 47mm magnetic PES filter holder, complete			00829 200300-01
	500ml, 47mm magnetic PES filter holder, complete			00829 200500-01
1	Lid kit	PP		00829 200300-36
2	Funnel	PES	300 ml 500 ml	00829 200300-30 00829 200500-30
3	Support base	PES	long stem	00829 200300-32
4	Stopper	Silicone	No. 8	00829 167110-16



MF 3 / 5



MISCELLANEOUS

MISCELLANEOUS

Balance.....	181
Moisture analyzer	184
Colony counter	185
Peristaltic pump	186
Vacuum pump (oil-free)	188
Vacuum pump (chemical resistant)	193
Compressor (oil-free).....	197
Air supply system	198
Gel documentation system	199
Electrophoresis.....	201
UV transilluminator	202
Water distillation apparatus	203
Plate stand & accessories	214
Lab burner & accessories.....	216
Lab jack	217
Stopwatch, counter, timer	217

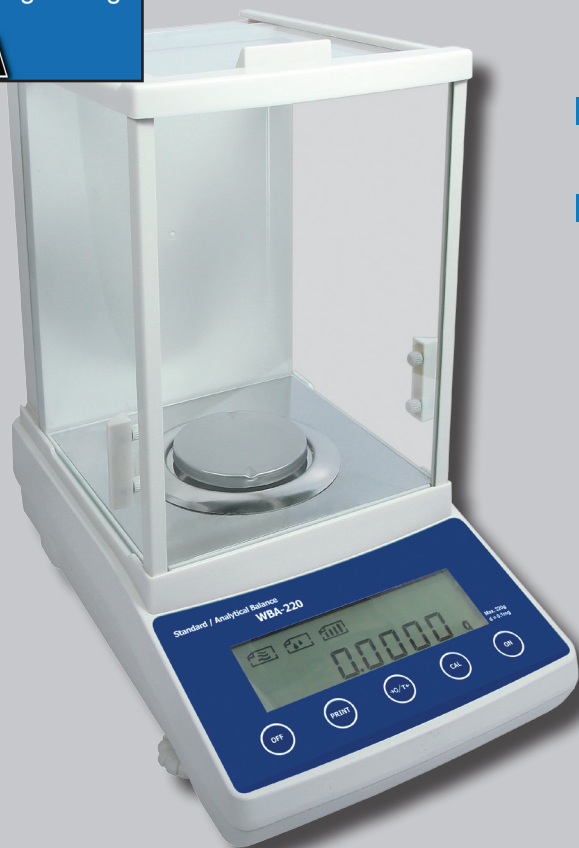

0.1 mg - 220 g

WBA-220 0.1mg - 220g analytical

Ideal for:

- analytical balancing

Features:

- various counting & weighing modes (g, ct, etc.)
- with Ø80 mm/Ø90 mm weighing plate and glass draft shield
- weighing response time adjustable
- electromagnetic base
- numeric linearity calibration
- built-in RS232C port for printer
- blue digital LCD display with backlight function
- 200g calibration weight included (only with Ext-CAL model)
- stabilization time (typical at fast) ≤ 8 seconds
- CE certified and unique serial number for tracing



200g calibration weight included WBA-220

Model	WBA-220 Ext-CAL	WBA-220A Int-CAL
Weighting range, weighting plate	0.1 mg - 220 g, Ø80 mm	0.1 mg - 220 g, Ø90 mm
Read out, reproducibility & linearity	0.1 mg	
Permissible temperature	5.0 - 35°C	
Weight modes	g / ct	g / ct / % / GN / dwt / etc.
Counting mode	counting & weighing mode available	
Calibration	external calibration, incl. 200g calibration weight	internal calibration, AUTO
Dimension & weight	190 x 240 x 265 mm, 6.3 kg	223 x 345 x 331 mm, 5.7 kg
Packaging size	290 x 420 x 490 mm, 8.3 kg	390 x 510 x 520 mm, 10.1 kg
Power supply	DC 9V with AC 230V adapter, 50/60 Hz	DC 15V with AC 230V adapter, 50/60 Hz
Order number	DH.WBA0220	DH.WBA0220A

NEW



Thermal printer, for balance WBA, RS232 connection for paper rolls (1 paper roll included)

Article	Order number
WBA-100 printer	DH.WBA100P
5x spare paper roll for WBA-100	DH.WBA0084



Thermal printer for balance WBA, RS232 connection for label paper rolls (1 label paper roll included)

Article	Order number
WBA-420 printer	DH.WBA420P
5x spare label paper roll for WBA-420	DH.WBA0771



Sample plates, 10 pieces

Diameter	Order number
Ø90mm	DH.WBA0005

Balance

high-precision lab balance, 0.001g - 320/640g, percent weighing mode

0.001 g - 320 g
- 640g

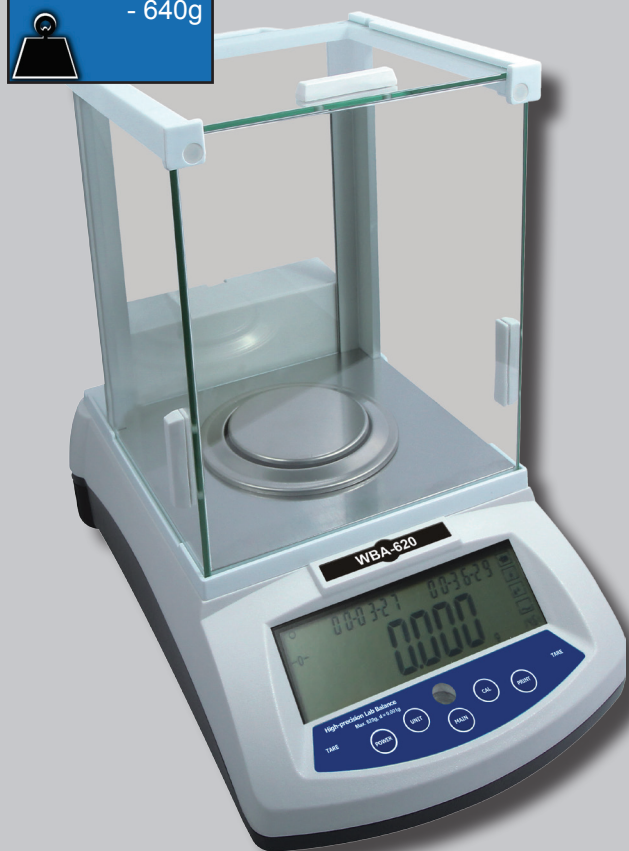

WBA-620

WBA -320 /-620 /-620A high-precision

Ideal for:

- high precision balancing

Features:

- percent (%) weighing mode available
- with Ø90 mm/Ø118 mm/Ø128 mm weighing plate and glass draft shield (included)
- weighing response time adjustable
- electromagnetic base
- numeric linearity calibration
- built-in RS232C & USB port for printer
- super-size backlight LCD display, can display present temperature
- time and date setting for recording data
- stabilization time (typical at fast) ≤ 8 seconds
- battery operation possible (6V, 1.2A)
- CE certified and unique serial number for tracing

Safety mechanism:

- four level anti-shock function adjustable
- default and auto lock present working mode



200g (WBA-320) / 500g (WBA-620)
calibration weight included

NEW

Model	WBA-320 Ext-CAL	WBA-620 Ext-CAL	WBA-620A Int-CAL
Weighting range, weighing plate	0.001 - 320 g, Ø 90 mm	0.001 - 620 g, Ø 128 mm	0.001 - 620 g, Ø 118 mm
Read out, reproducibility & linearity	0.001 g		
Permissible temperature	5.0 - 35°C		
Weight modes	% mode / g / ct / GN / dwt / etc.		
Counting mode	available counting & weighing mode		
Calibration	external calibration, 200g weight included	external calibration, 500g weight included	internal calibration, AUTO
Dimension & weight	223 x 345 x 331 mm, 3.6 kg	223 x 345 x 331 mm, 5.7 kg	
Packaging size	290 x 385 x 365 mm, 5.1 kg	390 x 510 x 520 mm, 10.1 kg	
Power supply	DC 12V with AC 230V adapter, 50/60 Hz	DC 12V with AC 230V adapter, 50/60 Hz	
Order number	DH.WBA0320	DH.WBA0620	DH.WBA0620A



Thermal printer, for balance WBA, RS232 connection
for paper rolls (1 paper roll included)

Article	Order number
WBA-100 printer	DH.WBA100P
5x spare paper roll for WBA-100	DH.WBA0084



Thermal printer for balance WBA, RS232 connection
for label paper rolls (1 label paper roll included)

Article	Order number
WBA-420 printer	DH.WBA420P
5x spare label paper roll for WBA-420	DH.WBA0771



Sample plates, 10 pieces

Diameter	Order number
Ø90mm	DH.WBA0005

Balance

standard lab balance, 0.01g - 3200g/6200g, big weighing plate, various counting & weighing modes

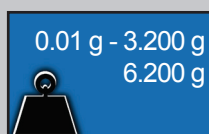

WBA 0.01g - 3200 g/6200 g standard

Ideal for:

- standard balancing purposes

Features:

- various counting & weighing modes (g, ct, GN, dwt, etc.)
- with 168 x 168 mm weighing plate and optional glass draft shield
- weighing response time adjustable
- electromagnetic base
- external calibration and numeric linearity calibration
- built-in RS232C & USB port for printer
- super-size backlight LCD display, can display present temperature
- stabilization time (typical at fast) ≤ 8 seconds
- 2 kg calibration weight included (only WBA-3200)
- CE certified and unique serial number for tracing

Safety mechanism:

- four level anti-shock adjustable function
- default and auto lock present working mode



WBA-3200



2 kg (WBA-3200) calibration weight included

Model	WBA-3200	WBA-6200
Weighting range, weighing plate	0.01 - 3200 g, 168 x 168 mm	0.01 - 6200 g, 168 x 168 mm
Read out, reproducibility & linearity	0.01 g	
Permissible temperature	5.0 - 35°C	
Weight modes	% mode/ g / ct / GN / dwt /etc.	
Counting mode	available counting & weighing mode	
Calibration	external calibration, 2 kg calibration weight included	external calibration, <u>no</u> weight included
Dimension & weight	195 x 295 x 90 mm, 2.6 kg	
Packaging size	243 x 377 x 163 x mm, 3.2 kg	
Power supply	DC 12V with AC 230V adapter, 50/60 Hz	
Order number	DH.WBA3200	DH.WBA6200

Thermal printer, for balance WBA, RS232 connection for paper rolls (1 paper roll included)

Article	Order number
WBA-100 printer	DH.WBA100P
5x spare paper roll for WBA-100	DH.WBA0084

Thermal printer for balance WBA, RS232 connection for label paper rolls (1 label paper roll included)

Article	Order number
WBA-420 printer	DH.WBA420P
5x spare label paper roll for WBA-420	DH.WBA0771

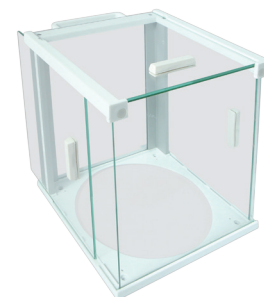

Glass draft shield for WBA-3200/6200 three slide doors (left, right, top)

Order number
DH.WBA0003

175 x 195 x h230 mm

Moisture analyzer

high-performance moisture analyzer, 0.001g - 110g, 0-100% (0.01%), ATRO 100-999% / 0-999%

0.001 g - 110 g
0-100 % : 0.01 %

WBA-110M moisture analyzer

Ideal for:

- measuring the percentage of moisture content

Features:

- Ø 90 mm weighing plate, stainless steel chamber and load cell sensor
- external calibration
- built-in RS232C & USB port for printer
- up to 15 values storable
- halogen light heating and PT 100 temperature sensor
- temperature and time selectable
- 100 g calibration weight and 10 sample plates included
- 3x display after drying: humidity (%) - reduce weight of liquid
dry mass (%) - weight of solid
ATRO (%) - 100 - 999%
- backlight LCD display
- CE certified and unique serial number for tracing

Safety mechanism:

- default and auto lock present working mode



100g calibration weight included

Model	WBA-110M
Weighting range, weighing plate	0.001 - 110 g, Ø 90 mm
Read out & reproducibility	0.1 mg
Permissible temperature	5.0 - 35°C
Temperature range & resolution	0.40 - 199°C /1°C
Moisture range / readability	0.00 - 100% / 0.01%
Dry residual	range 0.00 - 100.00%, read ability 0.01%
ATRO	100-999%, 0-999%
Dimension & weight	180 x 200 x 380 mm, 5.8 kg
Packing size	290 x 305 x 440 mm, 6.4 kg
Power supply	AC 200V, 50/60Hz
Order number	DH.WBA110M

Thermal printer, for balance WBA, RS232 connection for paper rolls (1 paper roll included)

Article	Order number
WBA-100 printer	DH.WBA100P
5x spare paper roll for WBA-100	DH.WBA0084

Thermal printer for balance WBA, RS232 connection for label paper rolls (1 label paper roll included)

Article	Order number
WBA-420 printer	DH.WBA420P
5x spare label paper roll for WBA-420	DH.WBA0771



Sample plates, 10 pieces

Diameter	Order number
Ø90mm	DH.WBA0005

Galaxy 330 with 4 display panels

Ideal for:

- total bacteria counting
- total coliform counting

Features:

- 4 displays showing present count and three previous counts
- possibility of average value
- storage for up to 100 counts
- subtraction function
- suitable for petri dishes from Ø90 to Ø150 mm and Ø60 mm
- pressure sensor allows to operate with any marking pen
- CE certified

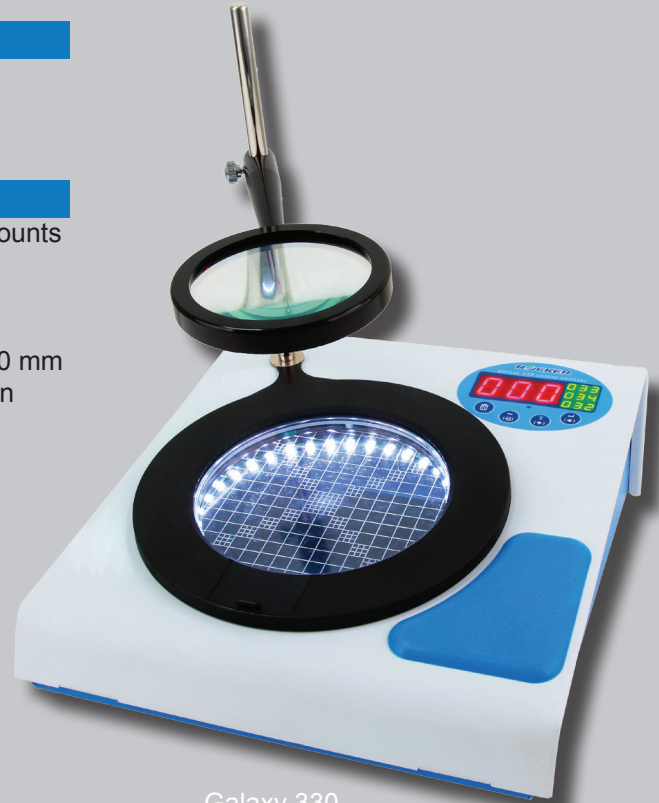

Galaxy 330

Model	Galaxy 330
Display	3-digit (0-999) LED display, 4 panels
Magnification	2 ~ 3 X
Petri dish diameter	Ø90-150 mm adjustable, Ø60 mm
Memory	up to 100 counts
Average	Yes
Zero reset	Yes
Count back	Yes
Illumination	LED (adjustable)
Pressure sensitivity	Adjustable
Acoustical counting signal	Adjustable
Output	USB
Dimension (LxWxH)	35.1 x 30.2 x 37 cm
Net weight	5.6 kg
Order number EU plug	00829 175330-02
Order number US plug	00829 175330-01

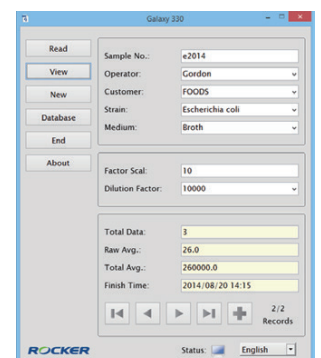

Model	Software
Purpose	Add, delete, search, print data as well as save as csv file for usage in a spreadsheet
Scope of supply	Software including USB stick and connection cable
Order number	00829 175330-12

Peristaltic pump



LabF3 with head for 1 tubing (included)

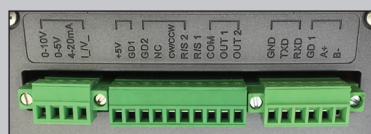

Interface

LabF3 peristaltic pump 0.00166 - 1330 ml/min

Ideal for:

- laboratory, industrial and equipment supporting
- water treatment systems
- filling product lines

Features:

- 4.3" touch screen control
- simple change of tubing head
- intelligent calibration function and online micro adjust function
- accurate angle control technology
- ABS plastic housing for high corrosion resistance
- CE certified

Controller:

- 4.3" touch screen
 - ◇ all values will be set via touch input
 - ◇ easy to understand
 - ◇ preset dispensing volume, dispensing time, pause time and copy numbers
 - ◇ storage for 60 commonly used filling modes
 - ◇ load-shedding memory function

Model	LabF3
Flow rate	0.00166 - 1330 ml/min
Speed range & resolution	0.1 - 350 rpm, 0.01 rpm
Flow rate resolution & accuracy	0.01 µl, < ±0.5%
Back suction angle	0 - 360°C
Outlet pressure	0.1 Mpa (0.86-1.0mm wall thickness tubing) 0.1 - 0.27 Mpa (1.6-2.0mm wall thickness tubing)
Motor	stepper motor
Circuit system	Shenchen-LabV-CIR
Operation system	Shenchen-LabV-EMB
Controller	4.3" touch screen with color LCD screen
Start / stop, direction signal	passive switch signal: foot pedals active switch signal: 5V, 12V and 24V
Interface	RS232, RS485 support Modbus protocol (TRU) mode
Dimension (LxWxH) & weight	216.4 x 157.3 x 230.7 mm, 4.4 kg
Condition temperature & humidity	0 - 40 °C, < 80%
IP rate	IP31
Power consumption	< 40 W
Power supply	1 Phase AC 120V, 60 Hz or AC 230V, 50/60 Hz
Order number 230V	6 350 001
Order number 120V	6 350 002

Scope of supply:

- Peristaltic pump LabF3 with power cord, Allen key and stylus (for touch screen)
- pump head YZ1515x (PSF) for 7 tubing sizes with wall thickness 1.6mm

Peristaltic pump

Easy load pump head suitable for LabF3



YZ1515



YZ2515



Model	Tubing	ID x wall (mm)	ml / rpm	Flow rates (ml/min) 1-350 rpm	Tubing max. pressure (Mpa)		Material	Usage	Order number	
					intermittent	continuous			3 rollers	6 rollers*
YZ1515x	#13	0.8x1.6	0.07	0.07 - 1330	0.27	0.17	PSF body stainless steel roller	general	for 1 tubing: 6 370 013	for 1 tubing: 6 370 014
	#14	1.6x1.6	0.27							
	#19	2.4x1.6	0.55							
	#16	3.1x1.6	0.82		0.24	0.14			for 2 tubings: 6 370 011	for 2 tubings: 6 370 012
	#25	4.8x1.6	1.7							
	#17	6.4x1.6	2.9							
YZ2515x	#18	7.9x1.6	3.8	1.7 - 1015	0.27	0.17	PPS body stainless steel roller	viscous liquids	for 1 tubing: 6 370 003	-
	#15	4.8x2.4	1.7							
	#24	6.4x2.4	2.9							

Please note: it is possible to mount multiple easy load pump heads in a row.

*The usage with 6 rollers will reduce the flow rate by half. Therefore, we do not recommend it for dispensing purposes.

Standard pump head, suitable for LabF3

Model	Tubing	ID x wall (mm)	Flow rates (ml/min) 1-600 rpm	Material	Usage	Order number
SN15-14	#14	1.6x1.6	0.024 - 144	PC body stainless steel roller	analytical instruments	6 370 020
SN15-16	#16	3.1x1.6	0.088 - 528	PC body stainless steel roller	analytical instruments	6 370 021
SN24	#24	6.4x2.4	0.25 - 1500	PC body stainless steel roller	general	6 370 022



SN15-14



SN15-16



SN24

Foot pedal switch, suitable for LabF3

Order number
6 370 050

1.80m power cord



Vacuum pump (oil-free)

ROCKER
make filtration easy

Rocker 300 / 300 DC up to -680 mmHg, 25 l/min, 50dB



Rocker 300



Rocker 300 DC

Ideal for:

- filtration for microbiology test
- air sampling
- suspended solid test
- vacuum filtration

Features:

- lubricant and oil free piston
- no air pollution
- maintenance-free
- Prote™ filter prevents liquid from being sucked into the pump and filters particles as well as moisture
- CE and CSA certified, Rocker 300 also RoHs certified and with IP 30 protection

Safety mechanism:

- thermal protection device ensures shutting down the pump when overheated and resumes working when the temperature cooled down

Model	Rocker 300		Rocker 300 DC
Max. power (W)	65	60	35
Max. current (A)	0.7	0.3	3
Max. vacuum	-680 mmHg (106 mbar)		-650 mmHg (146 mbar)
Max. flow rate	23 l/min	20 l/min	25 l/min
Moisture trap / vacuum regulator	Yes		Yes
Overflow protection	Yes		Yes
Motor ration	1750 rpm	1450 rpm	1800 rpm
Horse power	1/8 HP		1/8 HP
Noise level	50 dB		50 dB
Port thread	5/16 inch (8 mm)		5/16 inch (8 mm)
Net weight	4.1 kg		3.5 kg
Dimension (LxWxH)	26.8 x 13.5 x 20.4 cm		26.8 x 13.5x 20.4 cm
Power supply	1 Phase AC 120V, 60 Hz or AC 230V, 50/60 Hz		
Order number 120V	00829 167300-11	-	-
Order number 230V	-	00829 167300-22	-
Order number DC 12V	-	-	00829 167330-00

Vacuum pump (oil-free)

ROCKER
make filtration easy

Rocker 400 / 410 up to -735 mmHg, 37 l/min, 52dB



Rocker 400



Rocker 410

Ideal for:

- filtration for microbiology test
- air sampling
- suspended solid test
- vacuum filtration

Features:

- lubricant and oil free piston
- no air pollution
- maintenance-free
- Prote™ filter prevents liquid from being sucked into the pump and filters particles as well as moisture
- CE, CSA and RoHs certified, with IP 30 protection

Safety mechanism:

- thermal protection device ensures shutting down the pump when overheated and resumes working when the temperature cooled down

Model	Rocker 400		Rocker 410	
Max. power (W)	100	80	100	80
Max. current (A)	1.0	0.4	1.0	0.4
Max. vacuum	-680 mmHg (106 mbar)		-735 mmHg (33 mbar)	
Max. flow rate	37 l/min	34 l/min	23 l/min	20 l/min
Moisture trap / vacuum regulator	Yes		Yes	
Overflow protection	Yes		Yes	
Motor ration	1750 rpm	1450 rpm	1750 rpm	1450 rpm
Horse power	1/6 HP		1/6 HP	
Noise level	52 dB		52 dB	
Port thread	5/16 inch (8 mm)		5/16 inch (8 mm)	
Net weight	5.2 kg		5.2 kg	
Dimension (LxWxH)	31.0 x 13.5 x 20.4 cm		31.0 x 13.5 x 20.4 cm	
Power supply	1 Phase AC 120V, 60 Hz or AC 230V, 50/60 Hz			
Order number 120V	00829 167400-11	-	00829 167410-11	-
Order number 230V	-	00829 167400-22	-	00829 167410-22

Vacuum pump (oil-free)

ROCKER
make filtration easy

Rocker 800 / 810 up to -735mmHg, 100 l/min, 68dB



Rocker 800



Rocker 810

Ideal for:

- vacuum drying
- vacuum oven
- high volume degas
- high volume vacuum filtration

Features:

- lubricant and oil free piston
- no air pollution
- maintenance-free
- CE certified

Safety mechanism:

- thermal protection device ensures shutting down the pump when overheated and resumes working when the temperature cooled down

Model	Rocker 800		Rocker 810	
Max. power (W)	220	200	220	200
Max. current (A)	2.0	0.9	2.0	0.9
Max. vacuum	-670 mmHg (120 mbar)		-735 mmHg (33 mbar)	
Max. flow rate	100 l/min	84 l/min	60 l/min	50 l/min
Vacuum regulator	Yes		Yes	
Overflow protection	No		No	
Motor ration	1750 rpm	1450 rpm	1750 rpm	1450 rpm
Horse power	1/3 HP		1/3 HP	
Noise level	68 dB		68 dB	
Port thread	3/8 inch (10 mm)		3/8 inch (10 mm)	
Net weight	7.8 kg		7.8 kg	
Dimension (LxWxH)	34.5 x 17.5 x 20 cm		34.5 x 17.5 x 20 cm	
Power supply	1 Phase AC 120V, 60 Hz or AC 230V, 50/60 Hz			
Order number 120V	00829 167800-11	-	00829 167810-11	-
Order number 230V	-	00829 167800-22	-	00829 167810-22

Vacuum pump (oil-free)

ROCKER
make filtration easy

Rocker 801 / 811

up to -735 mmHg, 80 l/min, 68dB



Rocker 801



Rocker 811

Ideal for:

- vacuum drying
- vacuum oven
- high volume degas
- high volume vacuum filtration

Features:

- lubricant and oil free piston
- no air pollution
- maintenance-free
- Prote™ filter prevents liquid from being sucked into the pump and filters particles as well as moisture
- CE certified

Safety mechanism:

- thermal protection device ensures shutting down the pump when overheated and resumes working when the temperature cooled down

Model	Rocker 801		Rocker 811	
Max. power (W)	220	200	220	200
Max. current (A)	2.0	0.9	2.0	0.9
Max. vacuum	-670 mmHg (120 mbar)		-735 mmHg (33 mbar)	
Max. flow rate	80 l/min	68 l/min	48 l/min	40 l/min
Moisture trap / vacuum regulator	Yes		Yes	
Overflow protection	No		No	
Motor ration	1750 rpm	1450 rpm	1750 rpm	1450 rpm
Horse power	1/3 HP		1/3 HP	
Noise level	68 dB		68 dB	
Port thread	5/16 inch (8 mm)		5/16 inch (8 mm)	
Net weight	7.9 kg		7.9 kg	
Dimension (LxWxH)	34.5 x 17.5 x 20 cm		34.5 x 17.5 x 20 cm	
Power supply	1 Phase AC 120V, 60 Hz or AC 230V, 50/60 Hz			
Order number 120V	00829 167801-11	-	00829 167811-11	-
Order number 230V	-	00829 167801-22	-	00829 167811-22

Vacuum pump (oil-free)

ROCKER
make filtration easy

Rocker 430 -630 mmHg, 80 psi, up to 34 l/min



Rocker 430

Ideal for:

- filtration for microbiology test
- air sampling
- suspended solid test
- vacuum filtration

Features:

- lubricant and oil free piston
- no air pollution
- maintenance-free
- Prote™ filter prevents liquid from being sucked into the pump and filters particles as well as moisture
- CE and RoHs certified, with IP 30 protection

Safety mechanism:

- thermal protection device ensures shutting down the pump when overheated and resumes working when the temperature cooled down

Model	Rocker 430	
Max. power (W)	147	125
Max. current (A)	1.5	0.6
Max. vacuum	-630 mmHg (173 mbar)	
Max. pressure	80 psi	
Max. flow rate	34 l/min	28 l/min
Moisture trap / vacuum regulator	Yes	
Overflow protection	Yes	
Motor ration	1700 rpm	1450 rpm
Horse power	1/6 HP	
Noise level	52 dB	
Port thread	5/16 inch (8 mm)	
Net weight	5.5 kg	
Dimension (LxWxH)	24.7 x 23 x 26.9 cm	
Power supply	1 Phase AC 120V, 60 Hz or AC 230V, 50/60 Hz	
Order number 120V	00829 167430-11	-
Order number 230V	-	00829 167430-22

Vacuum pump (chemical resistant)

ROCKER
make filtration easy

Chemker 300 / 400 up to -670 mmHg, 20 l/min, 50dB



Chemker 300



Chemker 400

Ideal for:

- vacuum filtration
- gel electrophoresis
- solid phase extraction (SPE)
- solvent purification

Features:

- high chemical resistant due to PTFE materials
- no air pollution
- maintenance-free
- quiet operation and low vibration
- direct driven motor
- CE certified

Safety mechanism:

- thermal protection device ensures shutting down the pump when overheated and resumes working when the temperature cooled down

Model	Chemker 300		Chemker 400	
	Max. power (W)	70	30	90
Max. current (A)	0.8	0.32	1.1	0.5
Max. vacuum	-670 mmHg (120 mbar)		-670 mmHg (120 mbar)	
Max. flow rate	20 l/min	18 l/min	38 l/min	33 l/min
Motor rotation	1700 rpm	1450 rpm	1700 rpm	1450 rpm
Horse power	1/8 HP		1/6 HP	
Noise level	50 dB		50 dB	
Port thread	5/16 inch (8 mm)		5/16 inch (8 mm)	
Net weight	5.0 kg		7.0 kg	
Dimension (LxWxH)	20.3 x 11.2 x 20.9 cm		26.7 x 11.2 x 18.1 cm	
Power supply	1 Phase AC 120V, 60 Hz or AC 230V, 50/60 Hz			
Order number 120V	00829 169300-11	-	00829 169400-11	-
Order number 230V	-	00829 169300-22	-	00829 169400-22

Vacuum pump (chemical resistant)

ROCKER
make filtration easy

Chemker 410 / 411 up to -750 mmHg, 20 l/min, 50dB



Chemker 410



Chemker 411

Ideal for:

- vacuum filtration
- gel electrophoresis
- solid phase extraction (SPE)
- solvent purification
- rotary evaporator

Features:

- high chemical resistant due to PTFE materials
- no air pollution
- maintenance-free
- quiet operation and low vibration
- direct driven motor
- CE certified

Safety mechanism:

- thermal protection device ensures shutting down the pump when overheated and resumes working when the temperature cooled down

Model	Chemker 410		Chemker 411	
Max. power (W)	90	90	90	90
Max. current (A)	1.2	0.5	1.2	0.5
Max. vacuum	-750 mmHg (13 mbar)		-750 mmHg (13 mbar)	
Max. flow rate	20 l/min	18 l/min	20 l/min	18 l/min
Motor rotation	1700 rpm	1450 rpm	1700 rpm	1450 rpm
Horse power	1/6 HP		1/6 HP	
Noise level	50 dB		50 dB	
Port thread	5/16 inch (8 mm)		5/16 inch (8 mm)	
Net weight	7.0 kg		7.4 kg	
Glass vapor trap	-		yes	
Vacuum regulator	-		yes	
Dimension (LxWxH)	20.3 x 11.2 x 20.9 cm		26.7 x 11.2 x 18.1 cm	
Power supply	1 Phase AC 120V, 60 Hz or AC 230V, 50/60 Hz			
Order number 120V	00829 169410-11	-	00829 169411-11	-
Order number 230V	-	00829 169410-22	-	00829 169411-22

Hose barb

- suitable for all vacuum pumps
- made of brass

Port thread	Capacity	Order number
3/8 inch, 10 mm	1/8 PT	00829 167300-20
5/16 inch, 8 mm	1/8 PT	00829 167300-21
1/4 inch, 6 mm	1/8 PT	00829 167300-63
3/16 inch, 5 mm	1/8 PT	00829 167300-23
1/8 inch, 3 mm	1/8 PT	00829 167300-24
1/2 inch, 12 mm	1/4 SAE	00829 187100-32
3/8 inch, 10 mm	1/4 SAE	00829 187100-31
1/4 inch, 6 mm	1/4 SAE	00829 187100-34



Chemical resistant connector

- suitable for all vacuum pumps

Port thread	Capacity	Order number
5/16 inch, 8 mm	1/4 MPT	00829 169300-20



For oil free vacuum pumps - Chemker

Prote™ filter cartridge

- suitable for oil free vacuum pumps

For device...	Order number
300, 400, 410, 430	00829 167301-07
801, 811	00829 167601-07



For chemical resistant vacuum pumps - Rocker

Glass vapor trap

- suitable for chemical resistant vacuum pumps

For device...	Material	Order number
300, 400, 410	Glass	00829 169301-06



Moisture trap / Vacuum regulator

- suitable for oil free vacuum pumps

For device...	Material	Order number
300, 400, 410, 430	PC	00829 167301-06
801, 811	PC	00829 167601-06



Vapor trap / Vacuum regulator

- suitable for chemical resistant vacuum pumps

For device...	Material	Order number
300, 400, 410	Glass	00829 169311-06



Air outlet (copper muffler)

- suitable for oil free vacuum pumps

For device...	Order number
300, 400, 410, 430	00829 167300-42
800, 801, 810, 811	00829 167600-42



Pump accessories

1200 ml PES waste bottle

Specification	
Port thread (I.D. tubing)	5/16 inch (8 mm)
Graduated increment	100 ml
Overflow protection	Yes
Cap with suction fitting	Yes
Material	Container: PES Cover: PES Overflow prot.: PP
Order number	00829 197000-11



1200 ml PC waste bottle

Specification	
Port thread (I.D. tubing)	5/16 inch (8 mm)
Graduated increment	100 ml
Overflow protection	Yes
Cap with suction fitting	Yes
Material	Container: PC Cover: PES Overflow prot.: PP
Order number	00829 197000-11-PC



3000 ml PC waste bottle with grip

Specification	
Port thread (I.D. tubing)	5/16 inch (8 mm)
Graduated increment	200 ml
Overflow protection	Yes
Material	Container: PC Overflow prot.: PP
Order number	00829 167240-33



1200 ml PES waste bottle

Specification	
Port thread (I.D. tubing)	5/16 inch (8 mm)
Graduated increment	100 ml
Overflow protection	Yes
Material	Container & cover: PES Overflow prot.: PP
Order number	00829 197000-12



1000 ml / 3000 ml PC waste bottle

Specification	1000 ml	3000 ml
Port thread (I.D. tubing)	5/16 inch (8 mm)	
Graduated increment	100 ml	
Overflow protection	Yes	
Material	Container: PC Overflow prot.: PP	
Order number	00829 167200-31	00829 167200-33



2000 ml / 4000 ml HPDE waste bottle

Specification	2000 ml	4000 ml
Port thread (I.D. tubing)	1/4 inch (6.5 mm)	
Graduated increment	500 ml	
Overflow protection	No	Yes
Material	Cover: PP	
Order number	00829 167200-51	00829 167200-46



2000 ml / 4000 ml PP waste bottle

Specification	2000 ml	4000 ml
Port thread (I.D. tubing)	1/4 inch (6.5 mm)	
Graduated increment	500 ml	
Overflow protection	No	Yes
Material	Container: PP Cover: PP Overflow prot.: PP	
Order number	00829 167200-50	00829 167200-47



4000 ml PP waste bottle with drain

Specification	
Port thread (I.D. tubing)	1/4 inch (6.5 mm)
Graduated increment	500 ml
Overflow protection	Yes
Drain	Yes
Material	Container: PP Cover: PP Overflow prot.: PP Tube: rubber
Order number	00829 167200-48



1000 ml receiver flask with drain & silicone fixing sucker

Specification	
Port thread (I.D. tubing)	5/16 inch (8 mm)
Graduated increment	100 ml
Drain	Yes
Silicone fixing sucker	Yes
Stopper	No. 16 (optional)
Material	Container: Borosilicate glass Connector: PP
Order number	00829 167100-15



Fixing sucker for receiving bottles

Specification	
Suitable flask size	1000 ml
Material	Silicone
Order number	00829 167200-45



Compressor (oil-free)

ROCKER
make filtration easy

Rocker 320 / 420 100 psi, 14 l/min, 50dB



Rocker 320



Rocker 420

Ideal for:

- aeration
- pressure filtration

Features:

- no air pollution
- maintenance-free
- quiet operation and low vibration
- direct driven motor
- air outlet filter device for filtering particles, moisture and supply clean air
- CE, CSA and RoHs certified, with IP 30 protection

Safety mechanism:

- thermal protection device ensures shutting down the pump when overheated and resumes working when the temperature cooled down

Model	Rocker 320		Rocker 420	
Max. power (W)	90	85	147	125
Max. current (A)	0.9	0.4	1.5	0.6
Max. pressure (w/o moisture trap)	80 psi		80 psi	
Max. pressure (w. moisture trap)	80 psi		80 psi	
Max. flow rate	14 l/min	12 l/min	27 l/min	25 l/min
Moisture trap	yes		yes	
Motor rotation	1700 rpm	1400 rpm	1700 rpm	1400 rpm
Horse power	1/8 HP		1/6 HP	
Noise level	50 dB		52 dB	
Port thread	5/16 inch (8 mm)		5/16 inch (8 mm)	
Net weight	4.1 kg		5.2 kg	
Dimension (LxWxH)	27.2 x 13.6 x 16.5 cm		29.8 x 14.3 x 17.2 cm	
Power supply	1 Phase AC 120V, 60 Hz or AC 230V, 50/60 Hz			
Order number 120V	00829 167320-11	-	00829 167420-11	-
Order number 230V	-	00829 167320-22	-	00829 167420-22

Air supply system

ROCKER
make filtration easy

Rocker 440 40-60 psi, up to 27 l/min, 52dB



Rocker 440

Ideal for:

- fermenter
- bioreactor
- gas chromatography

Features:

- no air pollution
- maintenance-free
- quiet operation and low vibration
- direct driven motor
- air outlet filter device for filtering particles, moisture and supply clean air
- CE, CSA and RoHs certified, with IP 30 protection

Safety mechanism:

- thermal protection device ensures shutting down the pump when overheated and resumes working when the temperature cooled down

Model		Rocker 440					
Max. power (W)		147			125		
Max. current (A)		1.5			0.6		
Pressure range		40 - 60 psi					
Max. flow rate (w/o air tank)		27 l/min			25 l/min		
Max. flow rate (w. air tank)	20 psi	0-15 sec 40 l/min	15-30 sec decreasing	after 30 sec 27 l/min	0-15 sec 40 l/min	15-30 sec decreasing	after 30 sec 25 l/min
	40 psi	0-10 sec 52 l/min	10-25 sec decreasing	after 25 sec 27 l/min	0-10 sec 50 l/min	10-25 sec decreasing	after 25 sec 25 l/min
	60 psi	0-8 sec 65 l/min	8-22 sec decreasing	after 22 sec 27 l/min	0-8 sec 60 l/min	8-22 sec decreasing	after 22 sec 25 l/min
Moisture trap		yes					
Motor ration		1700 rpm			1400 rpm		
Horse power		1/6 HP					
Noise level		52 dB					
Port thread		5/16 inch (8 mm)					
Net weight		8.4 kg					
Dimension (LxWxH)		29.3 x 31.1 x 25.1 cm					
Power supply		1 Phase AC 120V, 60 Hz or AC 230V, 50/60 Hz					
Order number 120V		00829 167440-11			-		
Order number 230V		-			00829 167440-22		

Gel documentation system

portable gel documentation system with integrated camera and software

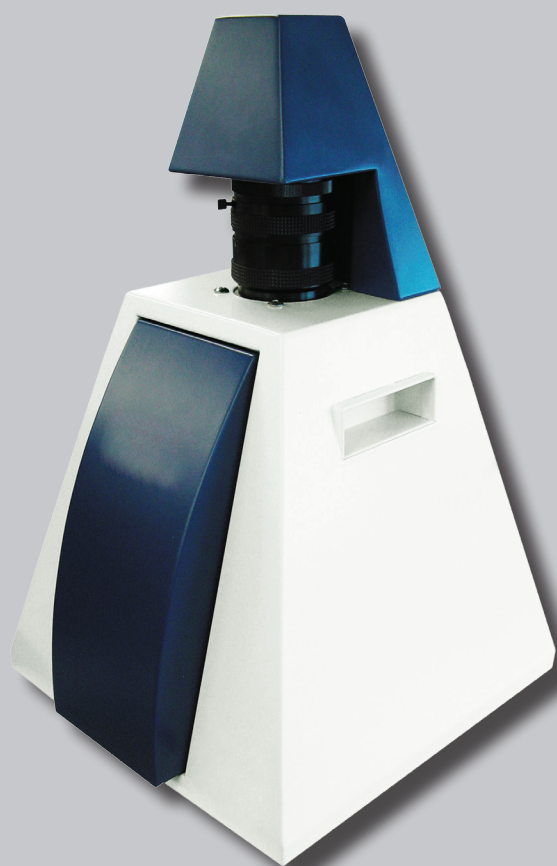

WGD-20 Gel documentation system

Ideal for:

- DNA, RNA gel imaging capture and analysis

Features:

- the most cost-effective system
- high precise and large calibre optical lens with zoom, focus and iris control
- digital CCD camera (resolution 1360x1024, 1.5 m pixel) with portable darkroom 10-bit CCD, available for 8-bit grey level image capturing
- very compact portable darkroom system for highest flexibility
- existing transilluminator can be used
- USB 2.0 interface for real-time images and data transfer
- power supply via USB
- WiseCapture II™ software: easy and fast view, capture and save gel images (included)
- TotalLab™ Quant software (WGD-20S): fully automatic, single button press complete image analysis in interesting area
- CE certified and unique serial number for tracing

Model	WGD-20	WGD-20S
CCD & pixel size	1/2" CCD, 4.65 x 4.65 um	
Lens mount & optical size	C mount, 7.6 x 6.2 mm	
Interface & Power	USB 2.0	
Iris & focal length	F1.0 fixed, 8 - 48 mm	
Operation temperature	-10°C to +50°C	
Software capability	Windows XP, Vista & 7	
DNA analysis software included	WiseCapture II™	WiseCapture II™ TotalLab™ Quant
Dimension & weight	260 x 260 x 430 mm, 9 kg	
Packing size	400 x 350 x 510, 18 kg	
Order number	DH.WGD00020	DH.WGD00024

Scope of supply:

- gel documentation system with CCD camera
- WiseCapture II™ software
- TotalLab™ Quant software (only WGD-20S)

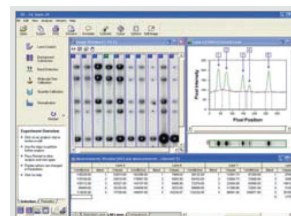

WiseCapture II™ software
easy and fast view, capture and save gel images included

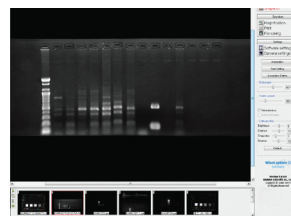

TotalLab™ Quant
automatic and manual lane detection, background subtraction, fully automatic band detection, molecular size / pI calibration, quantity calibration, normalization

more information on page 201

Accessories: Suitable UV transilluminator and software can be found on page 202

Gel documentation system

NEW

gel documentation system with integrated camera, UV transilluminator and software

WGD-G2 Gel documentation system

Ideal for:

- DNA, RNA gel imaging capture and analysis

Features:

- a high-quality optical lens with zoom, focus and iris control
- unified darkroom system with in-built sliding transilluminator (312nm, 6x 8W UV lamps) for very high safety
- white light: 3x LED lamps
- digital CCD camera (F1.0, 8 - 48mm, 1.45 megapixel, 1360x1024)
- USB 2.0 interface for real-time images and data transfer
- software: easy and fast view, capture and save gel images (included)
- CE certified and unique serial number for tracing
- optional software: TotalLab™ Quant



Model	WGD-G2
CCD & pixel size	1.45 megapixel, 1360x1024
Lens	F1.0-fixed, 8 - 48 mm, manual zoom
Interface	USB 2.0
Operation temperature	-10°C to +50°C
UV Transilluminator	312nm, 6 x 8W, 210 x 260mm
White light	3x LED lamps
Software capability	Windows 7
DNA analysis software included	Gel documentation software
Dimension & weight	360 x 380 x 700 mm, 24 kg
Packing size	430 x 490 x 830 mm, 28 kg
Power supply	1 Phase AC 120V, 60Hz or 230V, 50/60 Hz
Order number 230V	DH.WGD00300
Order number 120V	DH.WGD00301

Scope of supply:

- gel documentation system with CCD camera
- UV transilluminator 312nm (6x8W) (built-in)
- „View“ capture software

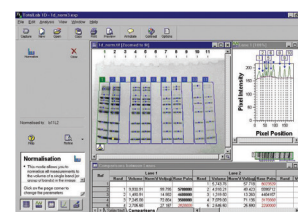

Gel dokumentation software
easy and fast view, capture and save gel images included

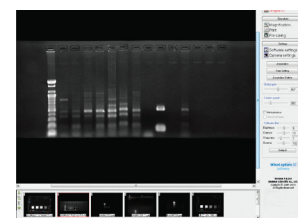

TotalLab™ Quant
automatic and manual lane detection, background subtraction, fully automatic band detection, molecular size / pl calibration, quantity calibration, normalization

more information on **201**

Accessories: Suitable UV lamps and software can be found on page 201-202

TotalLab™ Quant

TotalLab Quant is a suite of core analysis tools for quantitative image analysis applications in the Life Sciences. Tools are included for analysis of both bands and spots from a variety of samples.

Following modules are included:

- 1D electrophoresis gel and Western blot analysis
- array / dot blot / slot blot analysis
- colony counting & basic 2D spot measurement
- general feature-based image analysis

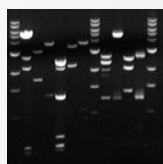
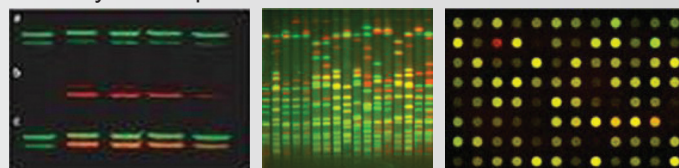

1D DNA gel

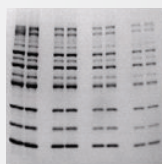

1D Protein gel

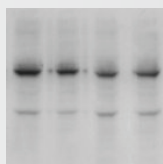

Western blot

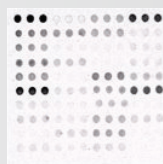

Protein array

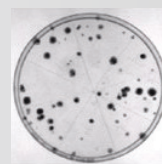

Colony counting

The user then has full control of the visualisation tools and data display - outputting only those data fields that are of importance as well as the images of choice.

Features:

- compatible with 21CFR part 11 compliance module
- automatic detection of lanes and bands
- automatic background subtraction
- image manipulation tools
- lane templates
- molecular weight calibration
- quantity calibration & normalisation
- profile deconvolution
- reports
- array analysis module
- colony counting module
- toolbox for general analysis

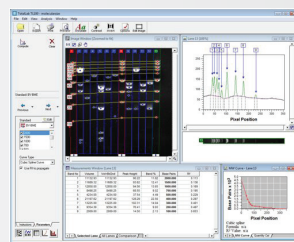
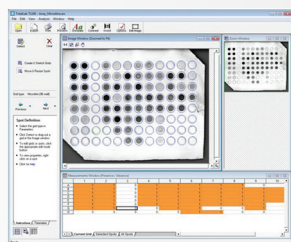

Software

TotalLab™ Quant (included WGD-20S / WGD-30S)

Order number

DH.WGD00100

Phoretix 1D

Phoretix 1D analyses gel in quantitative and qualitative ways. It can import TIF images from different sources.

Features:

- automatic detection of lanes and bands
- automatic background subtraction
- image manipulation tools
- lane templates
- molecular weight calibration
- quantity calibration & normalisation
- profile deconvolution
- Rf calibration
- band picking
- band pattern matching - single gel
- dendrogram - single gel
- reports
- array analysis module
- colony counting module
- toolbox for general analysis

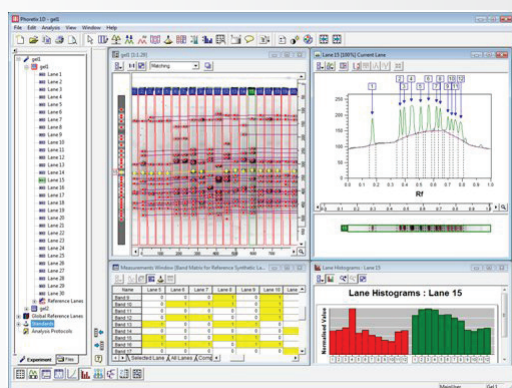

Phoretix 1D Pro

Phoretix 1D Pro includes all features of Phoretix 1D as well as a database for storing and controlling of 1D experiments, gels and lanes.

Additional features:

- band pattern matching - lanes across multiple gels
- band pattern queries
- dendrogram - lanes from multiple gels
- data archive and search facility
- classification and identification tools

Software

Phoretix 1D

Phoretix 1D Pro

Order number

DH.WGD00120

DH.WGD00121

UV transilluminator

UV transilluminator, standard and compact case-type, different wavelengths

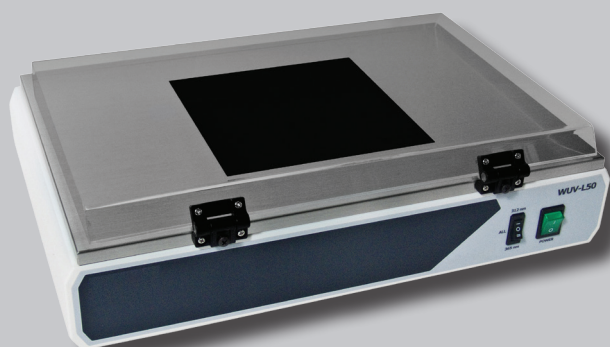

WUV-L50, standard case-type

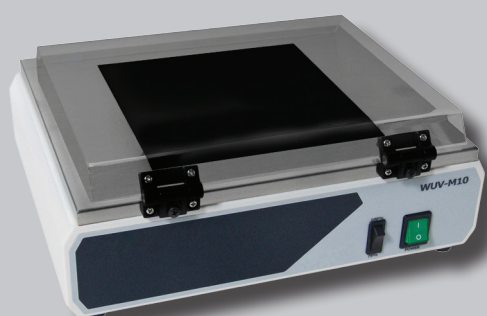

WUV-M20, compact case-type

WUV UV transilluminator

Ideal for:

- standard gel documentation and preparative work, especially for detection of very small amounts of DNA & RNA stained by EtBr

Features:

- low cost, robust, versatile, affordable & gentle excitation
- stainless steel frame and robust steel housing
- small amount of DNA & RNA stained by EtBr
- long-life electronic (low heat, no flickering)
- CE certified and unique serial number for tracing

Safety mechanism:

- hinged UV-blocking safety cover protects user from UV radiation

Controller:

- high (100%) / low (75%) intensity switch

Model	WUV-L10	WUV-L20	WUV-L50	WUV-M10	WUV-M20
Wavelength	single 365 nm	single 312 nm	dual 365 + 312 nm	single 365 nm	single 312 nm
Filter size	200 x 200 mm				
Body size type	standard case-type			compact case-type	
UV lamps	6 x 15 W			6 x 8 W	
Dimensions & weight	495 x 330 x 95 mm, 10 kg			350 x 275 x 95 mm, 8 kg	
Packing size & gross weight	520 x 380 x 220 mm, 12 kg			380 x 320 x 220 mm, 10 kg	
Power supply	1 Phase AC 120V, 60 Hz or AC 230V, 50/60 Hz				
Order number 230V	DH.WUV00010	DH.WUV00020	DH.WUV00050	DH.WUV00110	DH.WUV00120
Order number 120V	DH.WUV02010	DH.WUV02020	DH.WUV02050	DH.WUV00210	DH.WUV00220

Spare UV lamps for WUV UV transilluminator

Lamp	For devices	Article	Order number
365 nm, 15W	WUV-L10/L50	UVL365	DH.WUV01010
312 nm, 15W	WUV-L20/L50	UVL312	DH.WUV01020
365 nm, 8W	WUV-M10	UVM365	DH.WUV01110
312 nm, 8W	WUV-M20, WGD-G2	UVM312	DH.WUV02110

Water distillation apparatus

Biostill 4 | Biostill 10

Ideal for:

- all water distillation processes

Features:

- fully automatic operation
- borosilicate glass 3.3
- ideal for high purity water
- free of pyrogen and metal ions
- safety features allow unattended operation



Biostill 10



Biostill 4

Model	Biostill 4	Biostill 10
Distilled water production	4.3 l/h	10 l/h
pH		5.5 - 7
Water consumption	1 l/min	2 l/min
Conductivity at 20°C	1 µS/cm*	1.5 µS/cm*
Dimensions (W x D x H), weight	400 x 590 x 170 mm, 5.2 kg	960 x 360 x 400 mm, 23 kg
Packing size (W x D x H), gross weight	520 x 310 x 610 mm, 9.5kg	1130 x 610 x 770 mm, 30 kg
Power supply	1 Phase AC 120V, 60 Hz or AC 230V, 50/60 Hz	
Order number 230V	2 190 104	2 190 110 01

*As distillates are open to the atmosphere before measurements can be made, the value of conductivity is really much less (down to 10 times) than it is really measured. Any ultra pure water in contact with the atmosphere has a conductivity of 1-2 µS/cm and a pH of 5, due to the small amount of CO₂ (0.5 ppm) absorbed from the atmosphere.

Water purification system

NEW

pure water via reverse osmosis, 15 / 25 / 35 l/h, 0.2 – 30 $\mu\text{S}/\text{cm}$

WWP-20

Ideal for:

- production of pure water, up to 0.2-30 $\mu\text{S}/\text{cm}$

Features:

- with pretreatment system
- with RS232C interface and volumetric dispensing function with timer, level sensor included
- 2-phase-display for filter exchange
- backlight LCD display
- filter exchange message indicated by LCD display and blinking LED light
- CE certified and unique serial number for tracing

Controller:

- microprocess controller: one-touch technology



Pretreatment system

Model	WWP.RO-180	WWP.RO-280	WWP.RO-380
Flow rate	max. 15 l/h	max. 25 l/h	max. 35 l/h
Daily volume	60 l/day	100 l/day	120 l/day
Product water quality	0 to 30 $\mu\text{S}/\text{cm}^*$		
Water quality display	<ul style="list-style-type: none"> pure water: 0.2 to 250.0 $\mu\text{S}/\text{cm}$ feed water: 10 to 100 $\mu\text{S}/\text{cm}$ temperature: 0 to 99.9°C 		
Display	16 x 4 characters, digital backlight LCD display		
Controller	micro processor controller: one-touch technology		
Dimensions (W x D x H)	300 x 460 x 470 mm		
Power supply	210 - 230V, 50/60 Hz, 60W		
Order number	DH.WWP.RO180	DH.WWP.RO280	DH.WWP.RO380

*As distillates are open to the atmosphere before measurements can be made, the value of conductivity is really much less (down to 10 times) than it is really measured. Any ultra pure water in contact with the atmosphere has a conductivity of 1-2 $\mu\text{S}/\text{cm}$ and a pH of 5, due to the small amount of CO_2 (0.5 ppm) absorbed from the atmosphere.

The distillate amount/h depends in the water quality.

NEW

Water purification system

for ultra pure water, up to 1.5 l/min., up to 18.3 MΩ x cm

WWP.UP

Ideal for:

- production of ultra-pure water, up to 18.3 MΩ x cm

Features:

- with RS232C interface and volumetric dispensing function with timer
- 2-phase-display for filter exchange
- filter exchange message indicated by LCD display and blinking LED light
- backlight LCD display
- CE certified and unique serial number for tracing

Controller:

- microprocess controller: one-touch technology



Model	WWP.UP			
	Scholar	UV	Bio	Integrate
Flow rate	max. 1.5 l/Min.			
Product water quality	up to 18.3 MΩ x cm			
Water quality display	<ul style="list-style-type: none"> • ultra pure water: up to 18.3 MΩ x cm • feed water: 0 to 250 μS/cm • temperature: 0 to 99.9°C 			
Display	16 x 4 characters, digital backlight LCD display			
Filter composition	<ul style="list-style-type: none"> • 0.2 μm final capsule filter • UP Pack (DH.WW.UPS) 	<ul style="list-style-type: none"> • 0.2 μm final capsule filter • UP Pack (DH.WW.UPS) • 254/185 UV lamp 	<ul style="list-style-type: none"> • 0.2 μm final capsule filter • UP Pack (DH.WW.UPS) • MW 5000 UF filter (L) 	<ul style="list-style-type: none"> • 0.2 μm final capsule filter • UP Pack (DH.WW.UPS) • 254/185 UV lamp • MW 5000 UF filter (L)
Controller	micro processor controller: one-touch technology			
Dimensions (W x D x H)	300 x 500 x 470 mm			
Power supply	210 - 230V, 50/60 Hz			
Order number	DH.WWP.UP.S	DH.WWP.UP.U	DH.WWP.UP.B	DH.WWP.UP.I

TOC monitoring system is also available on request (TOC monitoring display range 0 - 200 ppb).

*As distillates are open to the atmosphere before measurements can be made, the value of conductivity is really much less (down to 10 times) than it is really measured. Any ultra pure water in contact with the atmosphere has a conductivity of 1-2 μS/cm and a pH of 5, due to the small amount of CO₂ (0.5 ppm) absorbed from the atmosphere.

The distillate amount/h depends in the water quality.

Water purification system

NEW

All-in-One system, reverse osmosis, up to 15l/h, pure water up to 2-30 $\mu\text{S}/\text{cm}$, ultra pure water bis 18.3 $\text{M}\Omega\text{cm}$

WWP.POWER

Ideal for:

- production of pure and ultra-pure water

Features:

- with pretreatment system
- with RS232C interface and volumetric dispensing function with timer, level sensor included
- 2-phase-display for filter exchange
- backlight LCD display
- filter exchange message indicated by LCD display and blinking LED light
- self-diagnosis for Ext- and Int-system, automatic cleaning, automatic sensor calibration
- CE certified and unique serial number for tracing

Controller:

- microprocessor controller: one-touch technology



Pretreatment system

Model	WWP.POWER			
	Scholar	UV	Bio	Integrate
Flow rate	max. 15 l/h			
Product water quality	pure water up to 0.2 - 250 $\mu\text{S}/\text{cm}$, ultra pure water up to 18.3 $\text{M}\Omega \times \text{cm}$			
Water quality display	<ul style="list-style-type: none"> • pure water: 0.2 - 250 $\mu\text{S}/\text{cm}$ • ultra pure water: up to $\leq 18.3 \text{ M}\Omega \times \text{cm}$ • feed water: 0 - 990 $\mu\text{S}/\text{cm}$ • temperature: 0 - 99.9°C 			
Display	16 x 4 characters, digital backlight LCD display			
Filter composition	<ul style="list-style-type: none"> • pretreatment system HMC-PT-3 • RO Pack • 0.2 μm final filter • UP Pack (scholar) 	<ul style="list-style-type: none"> • pretreatment system HMC-PT-3 • RO Pack • 0.2 μm final filter • UP Pack (S-UV) • 254/185 UV lamp 	<ul style="list-style-type: none"> • pretreatment system HMC-PT-3 • RO Pack • 0.2 μm final filter • UP Pack (BIO) • MW 5000 UF filter (M) 	<ul style="list-style-type: none"> • pretreatment system HMC-PT-3 • RO Pack • 0.2 μm final filter • UP Pack (INT) • 254/185 UV lamp • MW 5000 UF filter (M)
Controller	micro processor controller: one-touch technology			
Dimensions (W x D x H)	395 x 500 x 470 mm			
Power supply	210 - 230V, 50/60 Hz			
Order number	DH.WWP.POWER.S	DH.WWP.POWER.U	DH.WWP.POWER.B	DH.WWP.POWER.I

TOC monitoring system is also available on request (TOC monitoring display range 0 - 200 ppb).

With flow rate of 25l/h and 35l/h also available on request.

*As distillates are open to the atmosphere before measurements can be made, the value of conductivity is really much less (down to 10 times) than it is really measured. Any ultra pure water in contact with the atmosphere has a conductivity of 1-2 $\mu\text{S}/\text{cm}$ and a pH of 5, due to the small amount of CO_2 (0.5 ppm) absorbed from the atmosphere.

The distillate amount/h depends in the water quality.

Spare filter

Description	For device...	Filter replacement period	Order number
14" Super A/C filter	-	approx. 3 - 4 month	DH.WWP.PR14AC
10" A/C filter	-		DH.WWP.PR10AC
10" prefilter	-	approx. 20 - 40 days	DH.WWP.10PF
Pure water Pack I	DH.WWP.RO180	approx. 1 year	DH.WWP.ROM1
Pure water Pack II	DH.WWP.RO280		DH.WWP.ROM2
Pure water Pack III	DH.WWP.RO380		DH.WWP.ROM3
0.2 µm final capsule filter	-	approx. 6 - 8 month	DH.WWP.0.2CF
Ultra pure water Pack, Scholar / Bio	DH.WWP.POWER.S , DH.WWP.POWER.B,	approx. 1 year	DH.WWP.UPS
Ultra pure water Pack, Scholar-UV / Integrate	DH.WWP.POWER.U, DH.WWP.POWER.I		DH.WWP.UPU
MW 5000 UF filter (M)	-	approx. 6 - 8 month	DH.WWP.MWM
MW 5000 UF filter (L)	-	approx. 6 - 8 month	DH.WWP.MWL



14" Super A/C filter



10" Prefilter



Pure water Pack I

The above mentioned filter replacement period can change according to various factors such as feed water condition, producing volume and so on.



Final capsule filter



10" A/C Filter



Ultra Pure water Pack, Scholar / Bio



Ultra pure water Pack, Scholar-UV / Integrate



Pure water Pack II

Spare UV lamps

Description	Using time	Order number
254/185 UV lamp	approx. 2,000 h	DH.WWP.UV

Bottle, HDPE, aspiration

Capacity	Neck I.Ø	Dimensions	Order number white	Order number brown
5 l	Ø70 mm	Ø200 x 360 mm	DH.Bot3102	DH.Bot3106
10 l	Ø70 mm	Ø250 x 460 mm	DH.Bot3103	DH.Bot3107
20 l	Ø95 mm	Ø300 x 555 mm	DH.Bot3104	DH.Bot3108
50 l	Ø95 mm	Ø380 x 700 mm	DH.Bot3105	DH.Bot3109



Reactor systems

REA

NEW



Modular system

You can choose: glass vessels with glass lids or PTFE lids, agitator, vacuum pump and controller, heating mantle, chiller / cooler or heating circulator.

Wide range of vessels and comfort

- 0.1 - 100 l reaction vessels
- single or double walled glass vessels
- with or without drain valve at the bottom

Easy installation, assembly frame and components

- assembly frame for heavier work
- spare parts and optional components as modules available
- assembly frame as bench- or floor-type available
- height and length adjustable, frame removable
- 4 castors including 2 lockable castors

Controller

digital feedback controller / microprocessor controlled agitator (stirrer): LCD display, power bar graph, and status, overheat- and over current protection

Accessories

- use with k-temperature probe
- PTFE safety lid with screw joint or glass lid available
- Flexible PTFE connection for all joint parts
- with flexible safety coupling between stirring motor and shaft
- "45° DN 200" standardized flat flange system with a comprehensive range of accessories and spare parts



Reactor system | autom. lifting & tilting

jacketed reaction vessel, 5 - 100 l, digital agitator 50 - 1,000 rpm (800 rpm at 100 l)

NEW

REA-A



Ideal for:

- experiments, pilot production and production in chemistry, fine chemical engineering, pharmacy, synthesis and biomedical engineering
- dispersion, distillation, evaporation, homogenization and mixing processes at laboratories

Features:

- automatic lifting & tilting system: with induction gear motor, timing belt and pulley and limit switch for easy feeding and maintenance
- jacketed reaction vessel, ideal for -80°C to 260°C, 0.095 MPa, with drain valve
- fully adjustable assembly construction system made from stainless steel, with 4 castors including 2 lockable castors
- digital, high-torque agitator system
- storage function for rpm, timer and locking
- LCD display with power bar graph & status
- CE certified and unique serial number for tracing

Safety mechanism:

- flexible safety coupling between stirring motor and PTFE-shaft/impeller
- overheat- and over current protection

Controller:

- digital feedback controller/Microprocessor, **Jog-Shuttle control**

Model	REA-5A	REA-10A	REA-20A	REA-30A	REA-50A	REA-80A	REA-100A	
	direct control				remote control			
Vessel volume	5 l	10 l	20 l	30 l	50 l	80 l	100 l	
Jacket volume	ca. 1.2 l	ca. 2.6 l	ca. 5 l	ca. 8 l	ca. 12 l	ca. 20 l	ca. 25 l	
Vessel (O.Ø x H)	230 x 455 mm	270 x 550 mm	365 x 580 mm	365 x 710 mm	410 x 800 mm	460 x 970 mm	500 x 970 mm	
Vessel (I.Ø)	200 mm	230 mm	330 mm	330 mm	365 mm	410 mm	460 mm	
Heat hose connector	GL 25	GL 32		O.Ø 35 mm x I.Ø 18 mm flat flange & metal cap				
Drain tube size	glass tube O.Ø 34 mm x I.Ø 20 mm							
Digital stirrer (agitator)	Model	SHT-50DX			SHT-120T		SHT-140T	
	Viscosity, torque & flange	100,000 mPas, 300 Ncm, DN 150			150,000 mPas, 500 Ncm, DN200		160,000 mPas, 550 Ncm, DN200	
	Speed	50 - 1,000 rpm, resolution: display 1.0 rpm, control 1.0 rpm					50 - 800 rpm	
	Motor & rating	worm-gear DC motor (3.5:1 ratio) Input 83W, Output 75W, 1/10 HP			worm-gear DC motor (3.5:1 ratio) Input 130W, Output 120W, 1/6 HP			
Lifting speed & height	1 - 53 rpm, 15-step control, 200 - 500 mm							
Tilt angle	manual 30 degree							
Timer & alarm	99 h 59 min. (with continuous run), error status and timer end							
Shaft / impeller	Ø14 mm PTFE-encapsulated stainless steel shaft, exposed end Ø12 mm up to 50 l							
Power consumption	175 W				300 W			
Dimensions	800 x 620 x 1,900 mm		915 x 670 x 2,100 mm		1,000 x 720 x 2,400 mm	1,200 x 790 x 2,445 mm		
Power supply	1 Phase AC 230V, 50/60 Hz							
Order number with glass lid, 5 necks*	DH.Rea2531	DH.Rea2532	DH.Rea2533	DH.Rea2534	DH.Rea2535	DH.Rea2536	DH.Rea2537	
Order number with PTFE lid, 6 necks*	DH.Rea2541	DH.Rea2542	DH.Rea2543	DH.Rea2544	DH.Rea2545	DH.Rea2546	DH.Rea2547	

*Please note: Circulator and vacuum pump not included, please order separately!

Classic reactor system

NEW

jacketed reaction vessel, 5 - 100 l, digital agitator 50 - 1,000 rpm (800 rpm at 100 l)



REA-C

Ideal for:

- experiments, pilot production and production in chemistry, fine chemical engineering, pharmacy, synthesis and biomedical engineering
- dispersion, distillation, evaporation, homogenization and mixing processes at laboratories

Features:

- jacketed cylindrical reaction vessel, ideal for -80°C to 260°C, 0.095 MPa, with drain valve
- fully adjustable assembly construction system made from stainless steel, with 4 castors including 2 lockable castors
- digital, high-torque agitator system
- storage function for rpm, timer and locking
- LCD display with power bar graph & status
- CE certified and unique serial number for tracing

Safety mechanism:

- locking mode for more safety
- flexible safety coupling between stirring motor and PTFE-shaft/impeller

Model	REA-5C	REA-10C	REA-20C	REA-30C	REA-50C	REA-80C	REA-100C	
	direct control				remote control			
Vessel volume	5 l	10 l	20 l	30 l	50 l	80 l	100 l	
Jacket volume	ca. 1.2 l	ca. 2.6 l	ca. 5 l	ca. 8 l	ca. 12 l	ca. 20 l	ca. 25 l	
Vessel (O.Ø x H)	230 x 455 mm	270 x 550 mm	365 x 580 mm	365 x 710 mm	410 x 800 mm	460 x 970 mm	500 x 970 mm	
Vessel (I.Ø)	200 mm	230 mm	330 mm	330 mm	365 mm	410 mm	460 mm	
Heat hose connector	GL 25	GL 32		O.Ø 35 mm x I.Ø 18 mm flat flange & metal cap				
Drain tube size	glass tube O.Ø 34 mm x I.Ø 20 mm							
Digital stirrer (agitator)	Model	SHT-50DX			SHT-120T		SHT-140T	
	Viscosity, torque & flange	100,000 mPas, 300 Ncm, DN 150			150,000 mPas, 500 Ncm, DN 200		160,000 mPas, 550 Ncm, DN 200	
	Speed	50 - 1,000 rpm, resolution: display 1.0 rpm, control 1.0 rpm					50 - 800 rpm	
	Motor & rating	worm-gear DC motor (3.5:1 ratio) Input 83W, Output 75W, 1/10 HP			worm-gear DC motor (3.5:1 ratio) Input 130W, Output 120W, 1/6 HP			
Timer & alarm	99 h 59 min. (with continuous run), error status and timer end							
Shaft / impeller	Ø10/8 mm PTFE-encapsulated stainless steel shaft				Ø12/10 mm PTFE-encapsulated stainless steel shaft			
Power consumption	85 W				120 W			
Dimensions	45 x 45 x 130 cm		55 x 55 x 170 cm		60 x 60 x 180 cm		67 x 67 x 200 cm	
Power supply	1 Phase AC 230V, 50/60 Hz							
Order number with glass lid, 5 necks*	DH.Rea2511	DH.Rea2512	DH.Rea2513	DH.Rea2514	DH.Rea2515	DH.Rea2516	DH.Rea2517	
Order number with PTFE lid, 6 necks*	DH.Rea2521	DH.Rea2522	DH.Rea2523	DH.Rea2524	DH.Rea2525	DH.Rea2526	DH.Rea2527	

*Please note: Circulator and vacuum pump not included, please order separately!

NEW

Vacuum reactor set

reaction vessel, 0.5 - 20 l, digital agitator 50 - 1,000 rpm



REA-S

Ideal for:

- experiments, pilot production and production in chemistry, fine chemical engineering, pharmacy, synthesis and biomedical engineering
- dispersion, distillation, evaporation, homogenization and mixing processes at laboratories

Features:

- jacketed reaction vessel ideal for -80°C to 260°C, 0.095 MPa, with drain valve
- fully adjustable assembly construction system made from stainless steel, with 4 castors including 2 lockable castors, with heavy-duty stainless steel support guide for REA-S10 and REA-S20
- with heavy-duty aluminium vessel suspension support device, very easy vessel exchange
- digital, high-torque agitator system
- storage function for rpm, timer and locking
- LCD display with power bar graph & status
- CE certified and unique serial number for tracing

Safety mechanism:

- locking mode for more safety
- flexible safety coupling between stirring motor and PTFE-shaft/impeller

Model	REA-S0.5	REA-S1	REA-S2	REA-S3	REA-S5	REA-S10	REA-S20
Vessel volume	0,5 l	1 l	2 l	3 l	5 l	10 l	20 l
Jacket volume	ca. 0.2 l	ca. 0.4 l	ca. 0.8 l	ca. 1.1 l	ca. 1.2 l	ca. 2.6 l	ca. 5 l
Vessel (O.Ø x H)	130 x 140 mm	130 x 210 mm	160 x 250 mm	160 x 340 mm	230 x 455 mm	270 x 550 mm	365 x 580 mm
Vessel (I.Ø)	105 mm	105 mm	130 mm	130 mm	200 mm	230 mm	330 mm
Heat hose connector	GL 18			GL 25		GL 32	
Drain tube size	15 x 10 mm		18 x 13 mm		34 x 20 mm		
Digital stirrer (agitator)	Model	integrated control, SHT-50DX					
	Viscosity, torque & flange	100,000 mPas, 300 Ncm					
	Speed	50 - 1,000 rpm, resolution: display 1.0 rpm, control 1.0 rpm					
	Motor & rating	worm-gear DC motor (3.5:1 ratio), Input 83W, Output 75W, 1/10 HP					
Timer & alarm	99 h 59 min. (with continuous run), error status and timer end						
Shaft / impeller	Ø8/6 mm PTFE-encapsulated stainless steel shaft			Ø10/8 mm PTFE-encapsulated stainless steel shaft			
Power consumption	85 W						
Dimensions	45 x 45 x 75 cm		45 x 45 x 130 cm		50 x 50 x 150 cm		55 x 55 x 170 cm
Power supply	1 Phase AC 230V, 50/60 Hz						
Order number with glass lid, 5 necks*	DH.Rea2481	DH.Rea2482	DH.Rea2483	DH.Rea2484	DH.Rea2485	DH.Rea2486	DH.Rea2487
Order number with PTFE lid, 6 necks*	DH.Rea2491	DH.Rea2492	DH.Rea2493	DH.Rea2494	DH.Rea2495	DH.Rea2496	DH.Rea2497

*Please note: Circulator and vacuum pump not included, please order separately!

Reactor system | mantle heated

NEW

cylindrical reaction vessel, 2 - 20 l, digital agitator 50 - 1,000 rpm



REA-M

Ideal for:

- experiments, pilot production and production in chemistry, fine chemical engineering, pharmacy, synthesis and biomedical engineering
- dispersion, distillation, evaporation, homogenization and mixing processes at laboratories

Features:

- cylindrical reaction vessel, ideal for -80°C to 260°C, 0.095 MPa, with drain valve, with glass- or PTFE-lid
- digital, high-torque agitator system with storage function of rpm, timer and locking
- remote controlled heating mantle up to 450°C, with digital feedback control
- use with external direct contact-K-temperature probe (optional)
- both devices with digital backlight LCD-display
- CE certified and unique serial number for tracing

Safety mechanism:

- flexible safety coupling between stirring motor and PTFE-shaft/impeller
- overheat- and over current protection

Controller:

- digital *Jog-Shuttle-control*

Model	REA-2M	REA-4M	REA-6M	REA-10M	REA-20M
Heating mantle Watt & DN flange	550 W, DN100	800 W, DN150		1,400 W, DN150	2,000W, DN200
Vessel volume	2 l	4/5 l	6/7 l	10/12 l	20/21 l
Vessel (O.Ø x H)	130 x 240 mm	200 x 165 mm	215 x 165 mm	240 x 165 mm	250 x 215 mm
Drain tube size (O.Ø x l. Ø)	13 x 9 mm	15 x 10 mm	18 x 13 mm		
Digital stirrer (agitator)	Controller, model	direct control, SHT-50DX			
	Viscosity, torque & flange	100,000 mPas, 300 Ncm			
	Speed	50 - 1,000 rpm, resolution: display 1 rpm, control 1 rpm			
	Motor & rating	worm-gear DC motor (3.5:1 ratio), Input 83, Output 75 W, 1/10 HP			
	Timer & alarm	99 h 59 min. (with continuous run), error status and timer end			
	Display	digital backlight LCD-Display			
Controller	digital feedback control with Jog-Shuttle switch (Turn + Push)				
Shaft / impeller	Ø8/6 PTFE-encapsulated stainless steel shaft		Ø10/8 PTFE-encapsulated stainless steel shaft		
Power consumption	635 W	855 W	935 W	1485 W	2085 W
Power supply	1 Phase AC 230V, 50/60 Hz				
Order number with glass lid, 5 necks*	DH.Rea2553	DH.Rea2554	DH.Rea2555	DH.Rea2556	DH.Rea2557
Order number with PTFE lid, 5 necks*	DH.Rea2563	DH.Rea2564	DH.Rea2565	DH.Rea2566	DH.Rea2567

NEW

Reactor system | mantle heated

flat flange-round flask, 2 - 50 l, digital agitator 50 - 1,000 rpm

REA-MR

Ideal for:

- experiments, pilot production and production in chemistry, fine chemical engineering, pharmacy, synthesis and biomedical engineering
- dispersion, distillation, evaporation, homogenization and mixing processes at laboratories

Features:

- flat flange-reaction vessel, ideal for -80°C to 260°C, 0.095 MPa, with drain valve, with glass- or PTFE-lid
- digital, high-torque agitator system with storage function of rpm, timer and locking
- remote controlled heating mantle up to 450°C, with digital feedback control
- use with external direct contact-K-temperature probe (optional)
- both devices with digital backlight LCD-display
- CE certified and unique serial number for tracing

Safety mechanism:

- flexible safety coupling between stirring motor and PTFE-shaft/impeller
- overheat- and over current protection

Controller:

- digital *Jog-Shuttle-control*



Model	REA-2MR	REA-4MR	REA-6MR	REA-10MR	REA-20MR	REA-50MR	
Heating mantle Watt & DN flange	450 W, DN100	750 W, DN120	850 W, DN120	1,500 W, DN150	2,000W, DN150	4,000W, DN200	
Vessel volume	2 l	3 l	5 l	10 l	20 l	50 l	
Vessel (O.Ø x H)	165 x 215 mm	185 x 240 mm	225 x 280 mm	280 x 350 mm	350 x 430 mm	480 x 650 mm	
Drain tube size (O.Ø x l. Ø)	13 x 9 mm	15 x 10 mm	18 x 13 mm				
Digital stirrer (agitator)	Controller, model	direct control, SHT-50DX				remote control, SHT-120T	
	Viscosity, torque & flange	100,000 mPas, 300 Ncm				150,000 mPas, 500 Ncm	
	Speed	50 - 1,000 rpm, resolution: display 1 rpm, control 1 rpm					
	Motor & rating	worm-gear DC motor (3.5:1 ratio), Input 83, Output 75 W, 1/10 HP				30 / 120 W, 1/6 PS	
	Timer & alarm	99 h 59 min. (with continuous run), error status and timer end					
	Display	digital backlight LCD-Display					
	Controller	digital feedback control with Jog-Shuttle switch (Turn + Push)					
Shaft / impeller	Ø8/6 PTFE-encapsulated stainless steel shaft		Ø10/8 PTFE-encapsulated stainless steel shaft			Ø12/10 PTFE-shaft	
Power consumption	635 W	855 W	935 W	1485 W	2085 W	4120 W	
Power supply	1 Phase AC 230V, 50/60 Hz						
Order number with glass lid, 5 necks*	DH.Rea2573	DH.Rea2574	DH.Rea2575	DH.Rea2576	DH.Rea2577	DH.Rea2578	
Order number with PTFE lid, 5 necks*	DH.Rea2583	DH.Rea2584	DH.Rea2585	DH.Rea2586	DH.Rea2587	DH.Rea2588	

Miscellaneous

Plate stand with stainless steel rod

- plate with silicone rubber pad (ST110, ST120) or heavy duty safety stand (ST200, KA1177)

Type	Rod (included)	Plate	Article	Order number
Silicone rubber pad	Ø16xh800 mm with thread	20 x 35 cm	ST110	DH.WOS501510
Silicone rubber pad	Ø23xh1000 mm with thread	30 x 40 cm	ST120	DH.WOS501515
Heavy duty safety stand	Ø23xh1200 mm	39 x up to 75 cm adjustable	ST200	DH.WOS501520
Heavy duty safety stand	Ø23xh800 mm	34 x 29 cm	KA1177	DH.WOS1177



Standard plate stand, thread M10

- with 1 adjustable foot, green painted steel, delivered without rod

Plate	Order number
210 x 130 mm	7 400 012
250 x 160 mm	7 400 014
315 x 200 mm	7 400 017

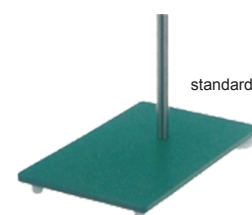

Rods for plate stands

- with thread or without thread
- made of stainless steel

Type	Rod	Article	Order number
without thread	Ø12 x h500 mm		7 400 180
without thread	Ø12 x h600 mm		7 400 181
without thread	Ø12 x h750 mm		7 400 182
without thread	Ø12 x h1000 mm		7 400 183
without thread	Ø12 x h1250 mm		7 400 184
without thread	Ø12 x h1500 mm		7 400 185
without thread	Ø16 x h800 mm	RD501	DH.WOS502001
without thread	Ø16 x h1000 mm	RD502	DH.WOS502002
without thread	Ø16 x h1200 mm	RD503	DH.WOS502003
without thread	Ø23 x h800 mm	RD531	DH.WOS502031
without thread	Ø23 x 1200 mm	RD533	DH.WOS502033
with thread M10	Ø12 x h500 mm		7 400 160
with thread M10	Ø12 x h600 mm		7 400 161
with thread M10	Ø12 x h750 mm		7 400 162
with thread M10	Ø12 x h1000 mm		7 400 163
with thread M10	Ø12 x h1250 mm		7 400 164
with thread M10	Ø12 x h1500 mm		7 400 165
with thread M8	Ø16 x h800 mm	RD511	DH.WOS502011
with thread M8	Ø16 x h1000 mm	RD512	DH.WOS502012
with thread M8	Ø16 x h1200 mm	RD513	DH.WOS502013
with thread M8	Ø23 x h800 mm	RD521	DH.WOS502021
with thread M8	Ø23 x h1000 mm	RD522	DH.WOS502022
with thread M8	Ø23 x h1200 mm	RD523	DH.WOS502023

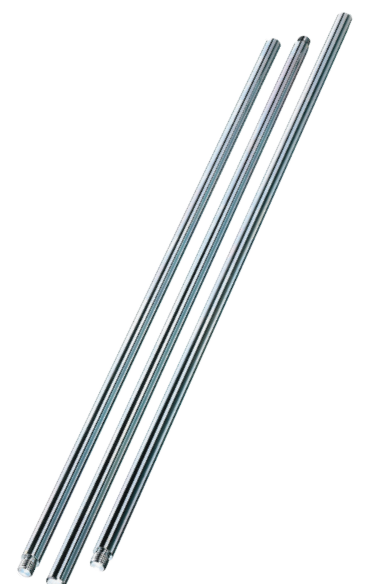

Stand rods for hotplates and magnetic stirrer with hotplate

For device(s)	Design	Measurements	Article	Order number
HP-30A, HP-30D MSH-30A, MSH-30D	without thread	Ø12.7xh450 mm	RD100	DH.WHP503011
HP-20A, HP-20D, HP-500D MSH-20A, MSH-20D MSH-50A, MSH-50D MSH-500D, SMHS	with thread	Ø12xh450 mm	RD200	DH.WHP503036



Bosshead

▪ suitable for all rods from Ø12mm - Ø23mm

Type	Material	Mounting	Order number
hook-type 90°	stainless steel	for rods up to Ø12mm	7 400 470
DIN12985, 90°, with screw	aluminium	for rods up to Ø16mm	7 400 500
DIN12985, 90°, with screw	cast iron	for rods up to Ø16mm	7 400 502
double-cross 90° & 180°	stainless steel	for rods up to Ø16mm	7 400 511
heavy-duty	cast aluminium	for rods up to Ø23mm	7 400 440

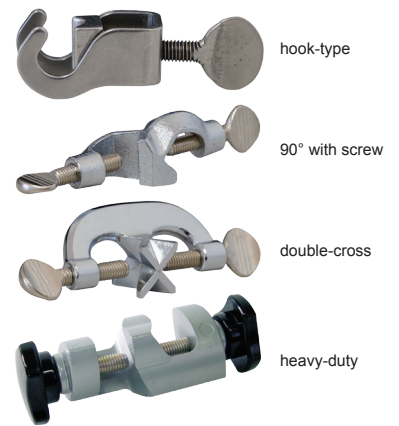

Clamp

Type	Material	Opening	Measurement	Order number
retort clamp 2 jaws PVC-coated	stainless steel	30mm		7 400 660
retort clamp 2 jaws PVC-coated	stainless steel	40mm		7 400 661
retort clamp 2 jaws PVC-coated	stainless steel	60mm		7 400 662
retort clamp 4 fingers silicone-coated	stainless steel	30-100 mm	190 x Ø12 mm	7 400 712
retort clamp 4 fingers silicone-coated	stainless steel	50-150 mm	190 x Ø12 mm	7 400 413
universal clamp 4 fingers silicone-coated cork-liner, hinge 180°	aluminium	0-80 mm	270 x Ø10 mm	7 400 720
condenser clamp 4 fingers PVC-coated	cast iron	50-100 mm	150 x Ø10 mm	7 400 730
flask clamp 2 jaws PVC-coated	chromed	12-45 mm	130 x Ø10 mm	7 400 830
burette clamp	chromed	4-20 mm	130 x Ø10mm	7 400 800
thermometer clamp with hook and bosshead	chromed	6-16 mm		7 400 810

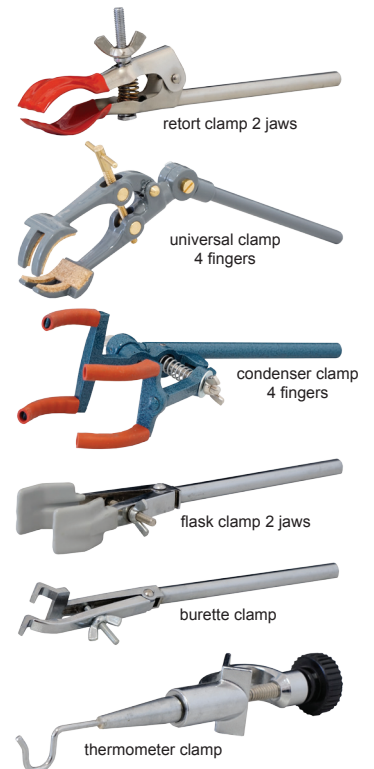

Ring

Type	Material	Ring Ø	Length	Order number
closed	stainless steel	50 mm	160 mm	7 400 900
		70 mm	200 mm	7 400 901
		100 mm	220 mm	7 400 902
		120 mm	220 mm	7 400 903
		140 mm	220 mm	7 400 904
closed with bosshead	stainless steel	50 mm	70 mm	7 400 925
		70 mm	70 mm	7 400 926
		100 mm	70 mm	7 400 927
		120 mm	70 mm	7 400 928
		140 mm	70 mm	7 400 929



Miscellaneous

Bunsen burner, with flame stabilizer and air regulation, made of nickel-plated brass

Type	Measurement	Order number Natural gas 23 mbar	Order number Propane / Butane 80 mbar	Order number Allgas 5-100 mbar
	Ø11 x 130 mm	7 401 000	7 401 010	-
with stopcock	Ø11 x 130 mm	7 401 001	7 401 011	-
	Ø13 x 150 mm	7 401 002	7 401 012	-
with stopcock & pilot flame	Ø13 x 160 mm	7 401 003	7 401 013	-
with stopcock	Ø11 x 130 mm	-	-	7 401 024
with stopcock, pilot flame and tilt stopcock	Ø13 x 175 mm	-	-	7 401 025



Meker burner, with air regulation, grid and stopcock, made of nickel-plated brass

Type	Measurement	Order number Natural gas 23 mbar	Order number Propane / Butane 80 mbar	Order number Allgas 5-100 mbar
grid head	Ø15 x 140 mm	7 401 030	7 401 040	7 401 050
grid head	Ø20 x 155 mm	7 401 031	7 401 041	7 401 051
grid head	Ø25 x 170 mm	7 401 032	7 401 042	7 401 052
grid head	Ø30 x 200 mm	7 401 033	7 401 043	7 401 053
perforated head	Ø20 x 155 mm	-	-	7 401 060
perforated head	Ø25 x 180 mm	-	-	7 401 061
perforated head	Ø30 x 185 mm	-	-	7 401 062



Safety burner, with needle valve, air regulation and pilot flame, made of nickel-plated brass

	Order number Natural gas 23 mbar	Order number Propane / Butane 80 mbar	Order number Allgas 5-100 mbar
	7 401 070	-	7 401 072



Safety burner, instant safety flame push button ignition. Used in microbiology, bacteriology and for general use for fast heat and fusion. Powered by a 1.5V battery

	Order number Natural gas 23 mbar	Order number Propane / Butane 80 mbar	Order number Allgas 5-100 mbar
	-	7 401 080	-



Digital gas burner

with LCD display, multi-lingual, joystick navigation, duration display, manual mode / floor switch

Type	Order number
Schuett Phoenix II standard controlled burning duration 1sec up to 120min, firing time display, automatic stop when not in use, overheat protection, exact economic flame adjustment, stable flame even at intense airflow, flame and ignition monitoring, angle adjustment 128 x 160 x h85mm, 100-240V, 50/60Hz, ~1kg	7 401 200
safety gas tubing for allgas	0.75m: 7 401 215
safety gas tubing for Propane / Butane, with thread connections	0.5m: 7 401 216 2.0m: 7 401 217
safety gas tubing for allgas with standard connection 1/2" for gas outlet (TAE)	1.0m: 7 401 218 2.0m: 7 401 219
adapter with pressure reducing valve for CV 360 butane cartridges	7 401 211
adapter with pressure reducing valve for C 206 butane cartridges and safety gas tubing 0.5m	7 401 212
glass splatter guard	7 401 213
flame shield, stainless steel	7 401 214



Tripod, for gas burner, made of stainless steel or tempered cast iron

Outer Ø (mm)	Height (mm)	Order number stainless steel	Order number tempered cast iron
80	150	7 401 300	-
100	180	7 401 301	7 401 311
120	210	7 401 302	7 401 312
140	210	-	7 401 313
140	220	7 401 304	-
160	230	7 401 306	-



Triangles, with quartz tubes, made of stainless steel wire or nickel-chrome wire

Length (mm)	Order number stainless steel wire	Order number nickel-chrome wire
40	7 401 320	7 401 330
50	7 401 321	7 401 331
60	7 401 322	7 401 332
70	7 401 323	7 401 333



Wire gauzes, stainless steel, flat

Dimension (mm)	Order number
135 x 135	7 401 350
155 x 155	7 401 351
175 x 175	7 401 352
195 x 195	7 401 353

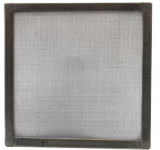

Wire gauzes, iron wire with ceramic centre

Dimension (mm)	Order number
100 x 100	7 401 360
120 x 120	7 401 361
140 x 140	7 401 362
160 x 160	7 401 363
180 x 180	7 401 364
200 x 200	7 401 365

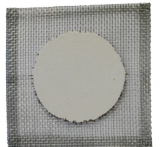

Lab-jacks

Material	Plate (mm)	Height min (mm)	Height max (mm)	Load max (kg)	Order number
stainless steel	100x100	55	120	10	7 402 000
stainless steel	160x160	60	275	15	7 402 001
stainless steel	200x200	60	275	20	7 402 002
stainless steel	240x240	60	275	30	7 402 003
stainless steel	300x300	130	470	25	7 402 004
aluminium, green	100x100	55	120	10	7 402 010
aluminium, green	160x160	60	275	15	7 402 011
aluminium, green	200x200	60	275	20	7 402 012
aluminium, green	240x240	60	275	30	7 402 013
aluminium, green	300x300	130	470	25	7 402 014

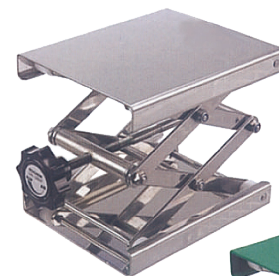

stainless steel

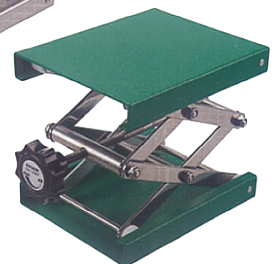

aluminium green

Stopwatches, counter and timer

Model		Order number
digital stopwatch	59min 59sec 1/100 start/stop, addition, split, reset, ABS housing, lanyard	8 484 150
counter/timer with alarm	timer up to 99min 99sec count-down 99min 99sec with magnet and clip	8 484 160
counter / timer with alarm and clock	timer up to 99min 59sec 1/100 count-down 99min 59sec 1/100 with magnet and clip	8 484 200
counter / timer with alarm and clock	timer up to 23h 59min 59sec count-down 23h 59min 59sec with magnet and clip	7 425 100
timer (mechanical)	0 - 60min	8 480 112



8 484 150



8 484 200



7 425 100



8 484 160



8 480 112

Premium Design
Premium Performance
Premium Quality

... more from
witeg

NEW

Microliter pipette
Witopet premium



Looking for the latest pipetting innovation at an attractive price? **Witopet premium** is just the right pipette for you. The ergonomic designed pipette of optimal weightiness requires extremely low pipetting forces making even prolonged pipetting as comfortable as possible. Other innovative features are the adjustable tip ejector button and the built-in volume locking. Moreover, **Witopet premium** is characterized by superior accuracy and precision. Our error ranges are better than those required by ISO 8655.

Your advantages at a glance:

- highest quality, made in France
- the best in its class performance, most competitive pricing
- extremely light weightiness, while the robustness still remains
- perfect ergonomic pipetting for highest comfort
- extremely low forces required for minimized risk of a cramp
- highest accuracy and precision, our error ranges are better than the DIN EN ISO 8655 requirements
- built-in volume locking for error-free results
- innovative tip ejector button, adjustable for right- and left-handed users
- secure tip ejection
- built-in recalibration mechanism (calibration tool inclusive)
- completely autoclavable at 121°C
- individual certificate and serial number
- DE-M marked according to the German calibration law, valid from January 2015

8 different sizes Single-Channel available from 0.2µl up to 10ml
4 different sizes Multi-Channel (8 & 12 channels) available from 0.5µl up to 300µl
more information at www.witeg.de



Consumables



Consumables

Magnet stirrer bar	28
Volumetric flask	220
Beaker	223
Erlenmeyer flask.....	224
Graduated cylinder	226
Bottles (Laboratory, B.O.D., Meplat, Culture)	228
Culture flasks.....	232
Extraction apparatus.....	233
Separatory funnels	233
Staining jars.....	235
Petri dish.....	235
Tubes (test, culture, centrifuge).....	236
Brush	241
Parafilm	241
Cleaning concentrate.....	241
Crucibles.....	242
Weighing accessories.....	243

Consumables

Volumetric flask with socket, class A



- made of Duran® tubing
- tolerance according to DIN EN ISO 1042
- DE-M marked according to the German calibration law
- standard and special sizes available
- inclusive batch certificate

Capacity	Tolerance	Socket	Order number		
ml	ml	ST	brown graduated with PE-stopper	blue graduated with PE-stopper	brown graduated with ST-hollow glass stopper
5	±0,025	7/16	3 664 000	3 664 000 BL	3 668 000
5	±0,040	10/19	3 664 015	3 664 015 BL	3 668 015
10	±0,025	7/16	3 664 001	3 664 001 BL	3 668 001
10	±0,040	10/19	3 664 012	3 664 012 BL	3 668 012
10*	±0,060	14/23	3 664 00114	3 664 00114 BL	3 668 00114
10*	±0,060	12/21	-	3 664 01212 BL	-
15*	±0,040	10/19	3 664 016	3 664 016 BL	3 668 016
20*	±0,040	7/16	3 664 021	3 664 021 BL	3 668 021
20	±0,040	10/19	3 664 002	3 664 002 BL	3 668 002
20	±0,060	12/21	3 664 013	3 664 013 BL	3 668 013
20*	±0,060	14/23	3 664 00214	3 664 00214 BL	3 668 00214
25	±0,040	10/19	3 664 003	3 664 003 BL	3 668 003
25	±0,060	12/21	3 664 014	3 664 014 BL	3 668 014
25*	±0,060	14/23	3 664 00314	3 664 00314 BL	3 668 00314
50	±0,060	12/21	3 664 005	3 664 005 BL	3 668 005
50	±0,100	14/23	3 664 006	3 664 006 BL	3 668 006
75*	±0,060	12/21	3 664 0075	-	3 668 0075
100	±0,100	12/21	3 664 010	3 664 010 BL	3 668 010
100	±0,100	14/23	3 664 011	3 664 011 BL	3 668 011
100*	±0,150	19/26	3 664 135	-	3 668 135
150*	±0,100	14/23	3 664 150	-	3 668 150
192,2*	±0,150	14/23	3 664 192	3 664 192 BL	3 668 192
200	±0,150	14/23	3 664 020	3 664 020 BL	3 668 020
250	±0,150	14/23	3 664 025	3 664 025 BL	3 668 025
300*	±0,150	14/23	3 664 030	-	3 668 030
350*	±0,150	19/26	3 664 035	-	3 668 035
368,3*	±0,150	19/26	-	3 664 368 BL	-
400*	±0,250	19/26	3 664 040	-	3 668 040
500*	±0,250	14/23	3 664 049	-	3 668 049
500	±0,250	19/26	3 664 050	3 664 050 BL	3 668 050
600*	±0,400	24/29	3 664 060	-	3 668 060
800*	±0,400	24/29	3 664 080	-	3 668 080
900*	±0,400	24/29	3 664 090	-	3 668 090
1000	±0,400	24/29	3 664 100	3 664 100 BL	3 668 100
1000	±0,600	29/32	3 664 101	3 664 101 BL	3 668 101
2000	±0,600	29/32	3 664 200	3 664 200 BL	3 668 200
3000*	±0,800	29/32	3 664 300	3 664 300 BL	3 668 300
5000*	±1,200	29/32	3 664 499	-	3 668 499
5000	±1,200	34/35	3 664 500	3 664 500 BL	3 668 500

* special size in addition to the ISO 1042 range, with conformity certificate



NEW

All volumetric flasks with ground joint neck can be ordered with spout.

Just add „A“ at the end of the order number.

Example: „3 664 005 A“ or „3 664 100 BL A“

NEW

All brown graduated volumetric flasks with ST-hollow glass

stoppers can be ordered with blue graduation.

Just add „BL“ at the end of the order number.

Example: „3 668 014 BL“ or „3 668 500 BL“



Volumetric flask with socket amber-stained, class A

- made of borosilicate glass 3.3
- tolerance according to DIN EN ISO 1042
- DE-M marked according to the German calibration law
- standard and special sizes available
- inclusive batch certificate



Capacity	Tolerance	Socket	Order number	
ml	ml	ST	white graduated with ST-hollow glass stopper	white graduated with PE-stopper
2	±0.040	10/19	3 670 022	3 670 022 P
5	±0.025	7/16	3 670 000	3 670 000 P
5	±0.040	10/19	3 670 015	3 670 015 P
10	±0.025	7/16	3 670 001	3 670 001 P
10	±0.040	10/19	3 670 012	3 670 012 P
10*	±0.060	14/23	3 670 00114	3 670 00114 P
15*	±0.040	10/19	3 670 016	3 670 016 P
15*	±0.060	12/21	3 670 0016	3 670 0016 P
20*	±0.040	7/16	3 670 013 7	3 670 013 7 P
20	±0.040	10/19	3 670 002	3 670 002 P
20	±0.060	12/21	3 670 013	3 670 013 P
20*	±0.060	14/23	3 670 017	3 670 017 P
25	±0.040	10/19	3 670 003	3 670 003 P
25	±0.060	12/21	3 670 014	3 670 014 P
25*	±0.060	14/23	3 670 018	3 670 018 P
50	±0.060	12/21	3 670 005	3 670 005 P
50	±0.100	14/23	3 670 006	3 670 006 P
100	±0.100	12/21	3 670 010	3 670 010 P
100	±0.100	14/23	3 670 011	3 670 011 P
125*	±0.100	14/23	3 670 125	3 670 125 P
150*	±0.100	14/23	3 670 150	3 670 150 P
200	±0.150	14/23	3 670 020	3 670 020 P
250	±0.150	14/23	3 670 025	3 670 025 P
250*	±0.400	29/32	3 670 025 29	3 670 025 29 P
300*	±0.150	14/23	3 670 030	3 670 030 P
500*	±0.250	14/23	3 670 049	3 670 049 P
500	±0.250	19/26	3 670 050	3 670 050 P
500*	±0.400	29/32	3 670 051	3 670 051 P
1000	±0.400	24/29	3 670 100	3 670 100 P
1000	±0.600	29/32	3 670 101	3 670 101 P
2000	±0.600	29/32	3 670 200	3 670 200 P
5000	±1.200	34/35	3 670 500	3 670 500 P

* special size in addition to the ISO 1042 range, with conformity certificate



Volumetric flask with screw cap, class A

- made from Duran® tubing
- tolerance according to DIN EN ISO 1042
- DE-M marked according to the German calibration law
- inclusive batch certificate



Capacity	Tolerance	Screw thread	Order number	
ml	ml	GL	brown graduated with screw cap	
5	±0,040	14	3 642 000	
10	±0,040	14	3 642 001	
20	±0,040	14	3 642 002	
25	±0,040	14	3 642 003	
50	±0,060	18	3 642 005	
100	±0,100	18	3 642 010	
200	±0,150	18	3 642 020	
250	±0,150	18	3 642 025	
500	±0,250	25	3 642 050	
1000	±0,400	32	3 642 100	
2000	±0,600	32	3 642 200	
5000	±1,200	32	3 642 500	



Consumables

Volumetric flask trapezoidal with socket class A



- made of Duran® tubing
- tolerance according to DIN EN ISO 1042
- DE-M marked according to the German calibration law
- standard and special sizes available
- inclusive batch certificate

Capacity ml	Tolerance ml	Socket ST	Order number	
			brown graduated with PE-stopper	blue graduated with PE-stopper
1	±0,025	7/16	3 669 000	3 669 000 BL
1	±0,040	10/19	3 669 00010	3 669 00010 BL
2	±0,025	7/16	3 669 001	3 669 001 BL
3*	±0,025	7/16	3 669 002	3 669 002 BL
3*	±0,040	10/19	-	3 669 00210 BL
4*	±0,025	7/16	3 669 0024	-
4*	±0,040	10/19	3 669 035	3 669 035 BL
5	±0,025	7/19	3 669 003	3 669 003 BL
5	±0,040	10/19	3 669 015	3 669 015 BL
10	±0,025	7/16	3 669 005	3 669 005 BL
10	±0,040	10/19	3 669 010	3 669 010 BL
20	±0,040	10/19	3 669 020	3 669 020 BL
25	±0,040	10/19	3 669 025	3 669 025 BL
25	±0,060	12/21	3 669 014	3 669 014 BL
50	±0,060	12/21	3 669 050	3 669 050 BL
50	±0,100	14/23	3 669 100	3 669 100 BL
100*	±0,100	12/21	3 669 200	3 669 200 BL
100*	±0,100	14/23	3 669 500	3 669 500 BL

* special size in addition to the ISO 1042 range, with conformity certificate



Volumetric flask with socket USP



- made of Duran® tubing
- tolerance according to ASTM E 288, produced according to DIN EN ISO 1024
- DE-M marked according to the German calibration law
- standard and special sizes available
- inclusive batch certificate

USP

Capacity ml	Tolerance USP ml	Socket ST	Order number			
			blue graduated with PE-stopper	blue graduated with ST-hollow glass stopper	brown graduated with PE-stopper	brown graduated with ST-hollow glass stopper
5	±0,02	10/19	3 664 015 BL USP	3 668 015 BL USP	3 664 015 USP	3 668 015 USP
10	±0,02	10/19	3 664 012 BL USP	3 668 012 BL USP	3 664 012 USP	3 668 012 USP
20*	±0,03	10/19	3 664 002 BL USP	3 668 002 BL USP	3 664 002 USP	3 668 002 USP
25	±0,03	10/19	3 664 003 BL USP	3 668 003 BL USP	3 664 003 USP	3 668 003 USP
25	±0,08	12/21	3 664 014 BL USP	3 668 014 BL USP	3 664 014 USP	3 668 014 USP
50	±0,05	12/21	3 664 005 BL USP	3 668 005 BL USP	3 664 005 USP	3 668 005 USP
100	±0,08	12/21	3 664 010 BL USP	3 668 010 BL USP	3 664 010 USP	3 668 010 USP
200	±0,10	14/23	3 664 020 BL USP	3 668 020 BL USP	3 664 020 USP	3 668 020 USP
250	±0,12	14/23	3 664 025 BL USP	3 668 025 BL USP	3 664 025 USP	3 668 025 USP
500	±0,20	19/26	3 664 050 BL USP	3 668 050 BL USP	3 664 050 USP	3 668 050 USP
1000	±0,30	24/29	3 664 100 BL USP	3 668 100 BL USP	3 664 100 USP	3 668 100 USP
2000	±0,50	29/32	3 664 200 BL USP	3 668 200 BL USP	3 664 200 USP	3 668 200 USP

* special size in addition to the ASTM E 288 range

amber stained version with white graduation on request



Beaker low form with spout

- made of Duran® tubing, borosilicate glass 3.3
- according to DIN 12331, ISO 3819
- with graduation (5ml and 10ml only at maximal capacity)

Capacity ml	Outer Ø mm	Height mm	Order number		
			Duran® Duran logo	Borosilicate 3.3 witeg logo	Borosilicate 3.3 neutral
5	22	30	5 500 005	5 500 005 B	5 500 005 S
10	26	35	5 500 010	5 500 010 B	5 500 010 S
25	32	48	5 500 025	5 500 025 B	5 500 025 S
50	39	55	5 500 050	5 500 050 B	5 500 050 S
100	51	71	5 500 100	5 500 100 B	5 500 100 S
150	55	81	5 500 150	5 500 150 B	5 500 150 S
250	69	95	5 500 250	5 500 250 B	5 500 250 S
400	82	100	5 500 400	5 500 400 B	5 500 400 S
600	92	115	5 500 600	5 500 600 B	5 500 600 S
800	98	136	5 500 800	-	5 500 800 S
1000	106	145	5 500 001	-	5 500 001 S
2000	132	185	5 500 002	-	5 500 002 S
3000	153	210	5 500 003	-	5 500 003 S
5000	170	270	5 500 051	-	5 500 051 S
10000	217	350	5 500 110	-	5 500 110 S

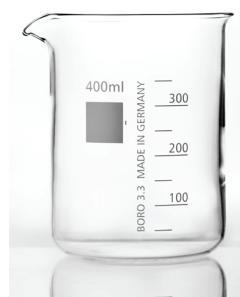

Set of beakers low form with spout

Content	Order number
Midi: 2x 50ml, 2x 100ml, 2x 150ml, 4x 250ml	5 500 525
Maxi: 2x 400ml, 4x 600ml, 4x 1000ml	5 500 599

Beaker tall form with spout

- made of Duran® tubing, borosilicate glass 3.3
- according to DIN 12331, ISO 3819
- with graduation

Capacity ml	Outer Ø mm	Height mm	Order number		
			Duran® Duran logo	Borosilicate 3.3 witeg logo	Borosilicate 3.3 neutral
50	38	66	5 502 050	5 502 050 B	5 502 050 S
100	48	80	5 502 100	5 502 100 B	5 502 100 S
150	53	96	5 502 150	5 502 150 B	5 502 150 S
250	61	117	5 502 250	5 502 250 B	5 502 250 S
400	70	130	5 502 400	-	5 502 400 S
600	82	143	5 502 600	-	5 502 600 S
800	89	171	5 502 800	-	5 502 800 S
1000	95	185	5 502 001	-	5 502 001 S
2000	118	236	5 502 002	-	5 502 002 S
3000	135	280	5 502 003	-	5 502 003 S

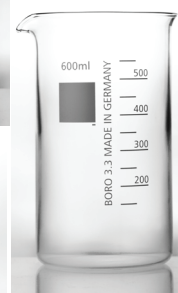

Beaker tall form

- made of Duran® tubing
- according to DIN 12331, ISO 3819
- with graduation

Capacity ml	Outer Ø mm	Height mm	Order number
			Duran® Duran logo
50	38	66	5 504 050
100	47	80	5 504 100
150	53	96	5 504 150
250	61	117	5 504 250
400	70	130	5 504 400
600	82	143	5 504 600
800	89	171	5 504 800
1000	95	185	5 504 001

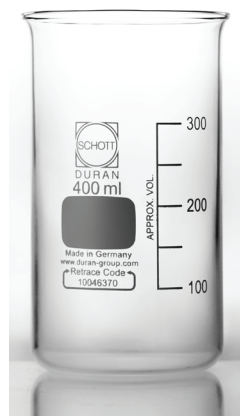

Consumables

Erlenmeyer flask with socket (conical flask)

- made of borosilicate glass 3.3
- with graduation
- clear glass, amber stained or economy
- according to DIN 12387

delivered without stopper!

Capacity	Socket	Outer Ø	Height			Order number
ml	ST	mm	mm	clear glass	amber stained	clear glass economy
5*	14/23	30	45	0 619 005	0 619 005 BR	0 619 005 E
10*		33	60	0 619 010	0 619 010 BR	0 619 010 E
25		42	70	0 619 025	0 619 025 BR	0 619 025 E
50		51	80	0 619 050	0 619 050 BR	0 619 050 E
100		64	100	0 619 100	0 619 100 BR	0 619 100 E
25	19/26	42	70	0 620 025	0 620 025 BR	0 620 025 E
50		51	80	0 620 050	0 620 050 BR	0 620 050 E
100		64	100	0 620 100	0 620 100 BR	0 620 100 E
200*		79	130	0 620 200	0 620 200 BR	-
250*		85	140	0 620 250	0 620 250 BR	0 620 250 E
50*	24/29	51	80	0 621 050	0 621 050 BR	0 621 050 E
100		64	100	0 621 100	0 621 100 BR	0 621 100 E
200*		79	130	0 621 200	0 621 200 BR	0 621 200 E
250*		85	140	0 621 250	0 621 250 BR	0 621 250 E
300*		87	150	0 621 300	0 621 300 BR	0 621 300 E
500*	29/32	105	170	0 621 500	0 621 500 BR	0 621 500 E
1000*		131	220	0 621 001	0 621 001 BR	0 621 001 E
50		51	80	0 622 050	0 622 050 BR	0 622 050 E
100		64	100	0 622 100	0 622 100 BR	0 622 100 E
200*		79	130	0 622 200	0 622 200 BR	0 622 200 E
250	45/40	85	140	0 622 250	0 622 250 BR	0 622 250 E
300*		87	150	0 622 300	0 622 300 BR	0 622 300 E
500		105	170	0 622 500	0 622 500 BR	0 622 500 E
1000		131	220	0 622 001	0 622 001 BR	0 622 001 E
2000*		166	280	0 622 002	-	-
200*	45/40	79	130	0 624 200	0 624 200 BR	-
250		85	140	0 624 250	0 624 250 BR	0 624 250 E
300*		87	150	0 624 300	0 624 300 BR	0 624 300 E
500		105	170	0 624 500	0 624 500 BR	0 624 500 E
1000		131	220	0 624 001	0 624 001 BR	0 624 001 E
2000*	45/40	166	280	0 624 002	0 624 002 BR	0 624 002 E
3000		187	310	0 624 003	0 624 003 BR	-
5000		220	365	0 624 005	0 624 005 BR	-

* special size in addition to DIN 12387

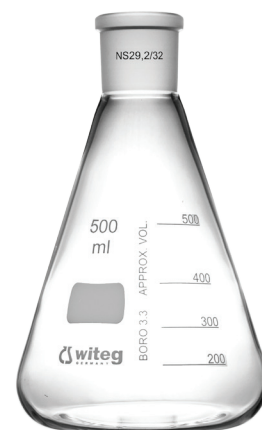

Stopper - hexagonal plate

- according to DIN 12254 / DIN 12252



For socket	Order number		
ST	PE-stopper	Borosilicate 3.3 ST-hollow glass stopper	Borosilicate 3.3 ST-hollow glass stopper amber stained
14/23	0 306 014	0 302 014	0 303 014
19/26	0 306 019	0 302 019	0 303 019
24/29	0 306 024	0 302 024	0 303 024
29/32	0 306 029	0 302 029	0 303 029
45/40	0 306 045	0 302 045	0 303 045

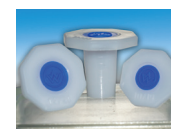

Erlenmeyer flask with screw cap

- made of borosilicate glass 3.3
- with graduation



Capacity	Thread	Max. Ø	Height	Order number
ml	GL	mm	mm	
25	18	42	70	5 507 001
50	25	51	85	5 507 002
100	25	64	105	5 507 003
250	32	85	140	5 507 004
500	32	105	175	5 507 005
1000	32	131	220	5 507 006
2000	45	166	280	5 507 007
3000	45	187	310	5 507 008
5000	45	220	365	5 507 009

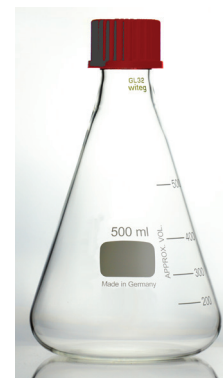

Erlenmeyer flask with safety pouring ring

- made of borosilicate glass 3.3
- with graduation, pouring ring made of PP (up to 140° heat-resistant), changeable



Capacity	Neck Ø	Max. Ø	Height	Order number
ml	mm	mm	mm	DURAN®-tubing DURAN® icon
50	22	51	85	5 507 505
100	22	64	105	5 507 510
200	34	79	131	5 507 520
250	34	85	140	5 507 525
300	34	87	156	5 507 530
500	34	105	175	5 507 550



Erlenmeyer flask narrow neck with rim

- made of Duran® tubing / borosilicate glass 3.3
- with graduation
- according to DIN 12387, ISO 1773



Capacity	Neck Ø	Max. Ø	Height	Order number		
ml	mm	mm	mm	DURAN®-tubing DURAN® logo	Borosilicate 3.3 witeg logo	Borosilicate 3.3 neutral
25	22	42	70	5 506 025	-	5 506 025 S
50	22	51	85	5 506 050	5 506 050 B	5 506 050 S
100	22	64	105	5 506 100	5 506 100 B	5 506 100 S
200	34	79	131	5 506 200	-	5 506 200 S
250	34	85	140	5 506 250	5 506 250 B	5 506 250 S
300	34	87	156	5 506 300	-	5 506 300 S
500	34	105	175	5 506 500	5 506 500 B	5 506 500 S
1000	42	131	220	5 506 001	5 506 001 B	5 506 001 S
2000	50	166	280	5 506 002	-	5 506 002 S
3000	50	187	310	5 506 003	-	5 506 003 S
5000	48	220	365	5 506 005	-	5 506 005 S

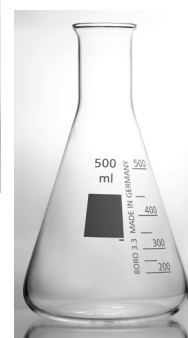

Erlenmeyer flask wide neck with rim

- made of Duran® tubing / borosilicate glass 3.3
- with graduation
- according to DIN 12387, ISO 1773



Capacity	Neck Ø	Max. Ø	Height	Order number		
ml	mm	mm	mm	DURAN®-tubing DURAN® logo	Borosilicate 3.3 witeg logo	Borosilicate 3.3 neutral
25	31	43	70	5 508 025	-	5 508 025 S
50	34	51	85	5 508 050	5 508 050 B	5 508 050 S
100	34	64	105	5 508 100	5 508 100 B	5 508 100 S
200	50	79	131	5 508 200	5 508 200 B	5 508 200 S
250	50	85	140	5 508 250	5 508 250 B	5 508 250 S
300	50	87	156	5 508 300	-	5 508 300 S
500	50	105	175	5 508 500	-	5 508 500 S
1000	50	131	220	5 508 001	-	5 508 001 S
2000	70	153	275	5 508 002	-	5 508 002 S

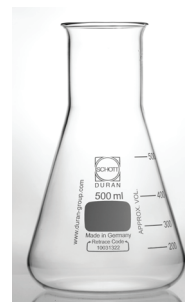

Consumables



Graduated cylinder - Class A - tall form - with spout or socket

- made of borosilicate glass 3.3 / DURAN components
- tolerance according to DIN ISO 4788
- DE-M marked according to the German calibration law
- inclusive batch certificate



Capacity	Division	Tolerance	Order number		Socket	Order number	
ml	ml	ml	brown graduated with spout	blue graduated with spout	ST	brown graduated with PE-stopper	blue graduated with PE-stopper
5	0,1	±0,05	3 715 000	3 715 000 BL	10/19	3 754 000	3 754 000 BL
10	0,2	±0,10	3 715 001	3 715 001 BL	10/19	3 754 001	3 754 001 BL
25	0,5	±0,25	3 715 003	3 715 003 BL	14/23	3 754 003	3 754 003 BL
50	1,0	±0,50	3 715 005	3 715 005 BL	19/26	3 754 005	3 754 005 BL
100	1,0	±0,50	3 715 010	3 715 010 BL	24/29	3 754 010	3 754 010 BL
250	2,0	±1,00	3 715 025	3 715 025 BL	29/32	3 754 025	3 754 025 BL
500	5,0	±2,50	3 715 050	3 715 050 BL	34/35	3 754 050	3 754 050 BL
1000	10,0	±5,00	3 715 100	3 715 100 BL	45/40	3 754 100	3 754 100 BL
2000	20,0	±10,00	3 715 200	3 715 200 BL	45/40	3 754 200	3 754 200 BL

Graduated cylinder - Class B - tall form - with spout or socket (mixing cylinders)

- made of borosilicate glass 3.3 / DURAN components
- tolerance according to DIN ISO 4788



Capacity	Division	Tolerance	Order number		Socket	Order number	
ml	ml	ml	brown graduated with spout	blue graduated with spout	ST	brown graduated with PE-stopper	blue graduated with PE-stopper
5	0,1	±0,1	3 705 000	3 705 000 BL	10/19	3 752 000	3 752 000 BL
10	0,2	±0,2	3 705 001	3 705 001 BL	10/19	3 752 001	3 752 001 BL
25	0,5	±0,5	3 705 003	3 705 003 BL	14/23	3 752 003	3 752 003 BL
50	1,0	±1	3 705 005	3 705 005 BL	19/26	3 752 005	3 752 005 BL
100	1,0	±1	3 705 010	3 705 010 BL	24/29	3 752 010	3 752 010 BL
250	2,0	±2	3 705 025	3 705 025 BL	29/32	3 752 025	3 752 025 BL
500	5,0	±5	3 705 050	3 705 050 BL	34/35	3 752 050	3 752 050 BL
1000	10,0	±10	3 705 100	3 705 100 BL	45/40	3 752 100	3 752 100 BL
2000	20,0	±20	3 705 200	3 705 200 BL	45/40	3 752 200	3 752 200 BL

Graduated cylinder - USP - tall form - with spout

- made of borosilicate glass 3.3 / DURAN components
- tolerance according to ASTM E 1272
- produced according to DIN ISO 4788
- DE-M marked according to the German calibration law
- inclusive batch certificate

NEW



Capacity	Division	Tolerance	Order number	
ml	ml	USP ml	blue graduated with spout	brown graduated with spout
5	0,1	±0,05	3 715 000 BL USP	3 715 000 USP
10	0,2	±0,10	3 715 001 BL USP	3 715 001 USP
25	0,5	±0,17	3 715 003 BL USP	3 715 003 USP
50	1,0	±0,25	3 715 005 BL USP	3 715 005 USP
100	1,0	±0,50	3 715 010 BL USP	3 715 010 USP
250	2,0	±1,00	3 715 025 BL USP	3 715 025 USP
500	5,0	±2,00	3 715 050 BL USP	3 715 050 USP
1000	10,0	±3,00	3 715 100 BL USP	3 715 100 USP
2000	20,0	±6,00	3 715 200 BL USP	3 715 200 USP



Brown graduated cylinder - Class B - low form - with spout

- made of borosilicate glass 3.3 / DURAN components
- tolerance according to DIN ISO 4788



Capacity	Division	Tolerance	Order number
ml	ml	ml	
5	0,5	±0,20	3 707 000
10	1,0	±0,30	3 707 001
25	1,0	±0,50	3 707 003
50	2,0	±1,00	3 707 005
100	2,0	±1,00	3 707 010
250	5,0	±2,00	3 707 025
500	10,0	±5,00	3 707 050
1000	20,0	±10,00	3 707 100
2000	50,0	±20,00	3 707 200



Brown graduated cylinder - Class B - tall form - with screw cap

- made of borosilicate glass 3.3 / DURAN components
- tolerance according to DIN ISO 4788



Capacity	Division	Tolerance	Thread	Order number
ml	ml	ml	GL	
10	0,2	± 0,2	14	3 751 001
25	0,5	± 0,5	18	3 751 003
50	1,0	± 1	25	3 751 005
100	1,0	± 1	32	3 751 010
250	2,0	± 2	45	3 751 025
500	5,0	± 5	45	3 751 050
1000	10,0	± 10	45	3 751 100
2000	20,0	± 20	45	3 751 200

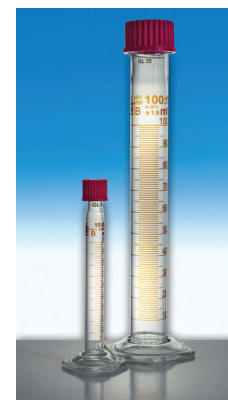

Brown graduated cylinder - Class B - tall form - with plastic base

- made of borosilicate glass 3.3 / DURAN components
- tolerance according to DIN ISO 4788



Capacity	Division	Tolerance	Order number			
ml	ml	ml	with spout	Ground joint neck and PE-Stopper	thread and screw cap (GL)	
5	0,1	±0,1	3 700 000	-	-	-
10	0,2	±0,2	3 700 001	10/19	3 750 001	14
25	0,5	±0,5	3 700 003	14/23	3 750 003	18
50	1,0	±1	3 700 005	19/26	3 750 005	25
100	1,0	±1	3 700 010	24/29	3 750 010	32
250	2,0	±2	3 700 025	29/32	3 750 025	45
500	5,0	±5	3 700 050	34/35	3 750 050	45
1000	10,0	±10	3 700 100	45/40	3 750 100	45
2000	20,0	±20	3 700 200	45/40	3 750 200	45



Consumables

Laboratory bottles - round - screw cap and pouring ring (PP) - graduated

- made of Duran® tubing / borosilicate glass 3.3

Capacity ml	Thread GL	Diameter mm	Height mm	Order number		
				Duran®	witeg logo*	neutral
25	25	36	74	5 526 025	-	-
50	32	46	91	5 526 050	-	-
100	45	56	105	5 526 100	5 526 100 B	5 526 100 S
250	45	70	143	5 526 250	5 526 250 B	5 526 250 S
500	45	86	181	5 526 500	5 526 500 B	5 526 500 S
1000	45	101	230	5 526 001	5 526 001 B	5 526 001 S
2000	45	136	265	5 526 002	5 526 002 B	5 526 002 S
5000	45	182	335	5 526 005	5 526 005 B	5 526 005 S
10000	45	227	415	5 526 010	5 526 010 B	5 526 010 S
15000	45	268	450	5 526 015	-	-
20000	45	288	510	5 526 020	5 526 020 B	5 526 020 S

* with I.D. code



Laboratory bottles - round - color coded - screw cap and pouring ring (PP) - graduated

- made of borosilicate glass (witeg logo)
- with I.D. code

Capacity ml	Thread GL	Diameter mm	Height mm	Order number			
				blue	yellow	green	red
100	45	56	105	5 526 100 BL	5 526 100 GE	5 526 100 GR	5 526 100 RO
250	45	70	143	5 526 250 BL	5 526 250 GE	5 526 250 GR	5 526 250 RO
500	45	86	181	5 526 500 BL	5 526 500 GE	5 526 500 GR	5 526 500 RO
1000	45	101	230	5 526 001 BL	5 526 001 GE	5 526 001 GR	5 526 001 RO
2000	45	136	265	5 526 002 BL	5 526 002 GE	5 526 002 GR	5 526 002 RO



Laboratory bottles - round - screw thread - graduated

- made of Duran® tubing / borosilicate glass 3.3
- clear glass or amber stained
- suitable screw caps: see 229

Capacity ml	Thread GL	Diameter mm	Height mm	Order number				
				Duran®		witeg logo*		
				clear glass	amber stained	clear glass	amber stained	
25	25	36	70	5 527 025	5 528 025	5 527 025 B	5 528 025 B	
50	32	46	87	5 527 050	5 528 050	5 527 050 B	5 528 050 B	
100	45	56	100	5 527 100	5 528 100	5 527 100 B	5 528 100 B	
250		70	138	5 527 250	5 528 250	5 527 250 B	5 528 250 B	
500		86	176	5 527 500	5 528 500	5 527 500 B	5 528 500 B	
1000		101	225	5 527 001	5 528 001	5 527 001 B	5 528 001 B	
2000		136	260	5 527 002	5 528 002	5 527 002 B	5 528 002 B	
5000		182	330	5 527 005	5 528 005	5 527 005 B	5 528 005 B	
10000		227	410	5 527 010	5 528 010	5 527 010 B	5 528 010 B	
15000		268	445	5 527 015	5 528 015	5 527 015 B	5 528 015 B	
20000		288	505	5 527 020	5 528 020	5 527 020 B	5 528 020 B	
500		80	101	152	5 527 600	5 528 600	5 527 600 B	5 528 600 B
1000	101		222	5 527 601	5 528 601	5 527 601 B	5 528 601 B	
2000	136		252	5 527 602	5 528 602	5 527 602 B	5 528 602 B	
5000	182		314	5 527 605	5 528 605	5 527 605 B	5 528 605 B	
10000	227		389	5 527 610	5 528 610	5 527 610 B	5 528 610 B	
15000	268		465	5 527 615	5 528 615	5 527 615 B	5 528 615 B	
20000	228		484	5 527 620	5 528 620	5 527 620 B	5 528 620 B	
1000	100		101	225	5 527 701	5 528 701	5 527 701 B	5 528 701 B
2000			136	255	5 527 702	5 528 702	5 527 702 B	5 528 702 B
5000			182	317	5 527 705	5 528 705	5 527 705 B	5 528 705 B
10000		227	393	5 527 710	5 528 710	5 527 710 B	5 528 710 B	
15000		268	465	5 527 715	5 528 715	5 527 715 B	5 528 715 B	
20000		228	488	5 527 720	5 528 720	5 527 720 B	5 528 720 B	

* with I.D. code



Reagent bottles - round - screw cap - made of soda glass

- narrow or wide neck
- with screw cap (PP)
- clear glass or amber glass

Capacity ml	Order number			
	narrow neck		wide neck	
	clear glass	amber glass	clear glass	amber glass
25	-	-	5 894 025	5 895 025
30	5 888 030	5 889 030	5 894 030	5 895 030
50	5 888 050	5 889 050	5 894 050	5 895 050
75	-	-	-	5 895 075
100	5 888 100	5 889 100	5 894 100	5 895 100
125	-	-	5 894 125	5 895 125
150	-	5 889 150	5 894 150	5 895 150
200	-	5 889 200	5 894 200	5 895 200
250	5 888 250	5 889 250	5 894 250	5 895 250
300	-	-	5 894 300	5 895 300
500	5 888 500	5 889 500	5 894 500	5 895 500
1000	5 888 001	5 889 001	5 894 001	5 895 001
2000	-	-	-	5 895 002



Laboratory bottles - square - screw thread - graduated

- with screw cap and pouring ring (PP) (only clear glass version)
- clear glass or amber stained
- made of Duran® tubing

Capacity ml	Thread GL	Diameter mm	Height mm	Order number	
				clear glass	amber stained*
100	32	50	109	5 523 311	-
100	45	50	109	-	5 523 331
250	45	64	143	5 523 312	5 523 332
500	45	78	181	5 523 313	5 523 333
1000	45	94	222	5 523 314	5 523 334

* delivered without cap and pouring ring



Screw caps for bottles with thread

- made of PBTP or PP
- top closed or with bore

Thread GL	Bore	Material	Color	Seal	Order number
25	-	PBTP	red	PTFE liner	0 175 025*
32	-	PBTP	red	PTFE liner	0 175 032*
45	-	PBTP	red	PTFE liner	0 175 045*
50	-	PP	neutral	PTFE liner	0 175 050**
80	-	PP	neutral	PTFE liner	0 175 080**
100	-	PP	neutral	PTFE liner	0 175 099**
25	-	PP	blue	lip seal	0 175 125**
32	-	PP	blue	lip seal	0 175 132**
45	-	PP	blue	lip seal	0 175 145**
45	-	PP	yellow	-	5 526 066**
45	-	PP	green	-	5 526 077**
45	-	PP	red	-	5 526 088**
45	-	PP	neutral	-	5 526 099**
GLS 80	-	PP	blue	lip seal	5 527 680**
GLS 100	-	PP	blue	lip seal	5 527 690**
25	Ø15mm	PBTP	red	-	0 176 025*
32	Ø20mm	PBTP	red	-	0 176 032*
45	Ø34mm	PBTP	red	-	0 176 045*
50	Ø38mm	PP	neutral	-	0 176 050**
80	Ø68mm	PP	neutral	-	0 176 080**
100	Ø85mm	PP	neutral	-	0 176 100**



Pouring rings for bottles

- made of PP or ETFE
- different colors
- autoclavable



Thread GL	Color	Material	Order number
32	blue	PP	0 175 201**
45	blue	PP	0 175 202**
45	yellow	PP	5 526 166**
45	green	PP	5 526 177**
45	red	PP	5 526 188**
45	white	PP	5 526 199**
32	red	ETFE	0 175 301*
45	red	ETFE	0 175 302*

*autoclavable up to 180°C

** autoclavable up to 140°C

Consumables

Reagent bottles - round - stopper - made of soda glass

- conical shoulder
- narrow or wide neck
- with glass or PE stopper
- clear glass or amber stained

Capacity ml	Socket ST	Neck	Order number			
			Glass stopper		PE stopper	
			clear glass	amber stained	clear glass	amber glass
50	14/15	narrow	5 868 050	5 869 050	5 870 050	5 871 050
100	14/23	narrow	5 868 100	5 869 100	5 870 100	5 871 100
250	19/26	narrow	5 868 250	5 869 250	5 870 250	5 871 250
500	24/29	narrow	5 868 500	5 869 500	5 870 500	5 871 500
1000	29/32	narrow	5 868 001	5 869 001	5 870 001	5 871 001
2000	29/32	narrow	5 868 002	5 869 002	5 870 002	5 871 002
50	24/20	wide	5 873 050	5 874 050	5 875 050	5 876 050
100	29/22	wide	5 873 100	5 874 100	5 875 100	5 876 100
250	34/24	wide	5 873 250	5 874 250	5 875 250	5 876 250
500	45/27	wide	5 873 500	5 874 500	5 875 500	5 876 500
1000	60/46	wide	5 873 001	5 874 001	5 875 001	5 876 001



Bottles - square - screw thread - narrow neck - made of soda glass

- with or without PE-coating **NEW**
- clear glass or amber stained
- suitable tamper-proof caps: 5 897 032, 5 897 045

Capacity ml	Thread GL	Diameter mm	Height mm	Order number		
				clear glass	clear glass PE-coating*	amber glass*
100	32	49	119	5 896 100	5 897 400	5 897 100
250	32	64	155	5 896 250	5 897 450	5 897 250
500	32	77	186	5 896 500	5 897 600	5 897 500
1000	45	97	223	5 896 001	5 897 701	5 897 001

* with pouring ring

Bottles - square - screw thread - wide neck - made of soda glass

- with or without PE-coating
- clear glass or amber stained
- suitable tamper-proof caps: 5 899 032, 5 899 045, 5 899 054, 5 899 060

Capacity ml	Thread GL	Diameter mm	Height mm	Order number		
				clear glass	clear glass PE-coating	amber glass
100	32	49	111	5 898 100	5 899 110	5 899 100
250	45	64	146	5 898 250	5 899 260	5 899 250
500	54	76	173	5 898 500	5 899 510	5 899 500
1000	60	98	213	5 898 001	5 899 011	5 899 001



Tamper-evident caps for square bottles

- made of PP
- blue

Thread GL	Suitable for	Order number	
		narrow neck	wide neck
32	narrow neck: 100, 250, 500ml wide neck: 100ml	5 897 032	5 899 032
45	narrow neck: 1000ml wide neck: 250ml	5 897 045	5 899 045
54	wide neck: 500ml	-	5 899 054
60	wide neck: 1000ml	-	5 899 060



B.O.D. bottles - Karlsruher bottles

- with funnel neck
- made of borosilicate glass

Capacity	Socket	Order number
ml	ST	
50	14/23	2 436 050
100	14/23	2 436 100
300	19/26	2 436 300

Suitable ST hollow glass stopper with extra long stem made of borosilicate glass

Socket	Order number
ST	
14/23	2 436 000
19/26	2 436 001



Winkler bottles for B.O.D. determination

- accurately adjusted
- with glass stopper and label
- made of clear glass

Capacity	Diameter	Height	Order number
ml	mm	mm	
100 - 150	53	103	2 911 100
250 - 300	70	130	2 911 250
500 - 600	87	170	2 911 500



Culture bottles (Meplat bottles)

- with screw thread and screw cap
- made of soda glass
- clear glass or amber stained

Capacity	Order number	
	clear glass	amber glass
50	5 890 050	5 891 050
100	5 890 100	5 891 100
125	5 890 125	5 891 125
150	-	5 891 150
200	-	5 891 200
250	5 890 250	5 891 250
500	-	5 891 500
1000	-	5 891 001



Culture flasks - different types

- made of borosilicate glass

Type	Capacity	Outer	Height	Neck Ø	Order number
	ml	mm	mm	mm	
Fernbach, bulgy shape	450	117	100		5 576 000
Roux, centric	1200	260	56	32	5 580 000
Roux, with screw cap GL 45	1200	260	56		5 581 800
Roux, conical neck, eccentric	1200				5 594 001

NEW

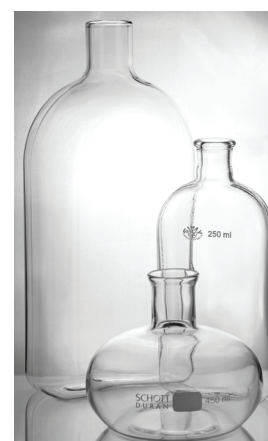

Consumables

Culture flasks (BIOGEN)

- Erlenmeyer shaped
- straight neck for metal caps, Ø 38mm
- made of borosilicate glass

Capacity	Flask Ø	Height	Order number
ml	mm	mm	
50	51	85	5 560 050
100	64	112	5 560 100
200	79	136	5 560 200
250	85	145	5 560 250
300	87	161	5 560 300
500	105	183	5 560 500
1000	131	232	5 560 001
2000	166	305	5 560 002
3000	187	310	5 560 003
5000	220	365	5 560 005

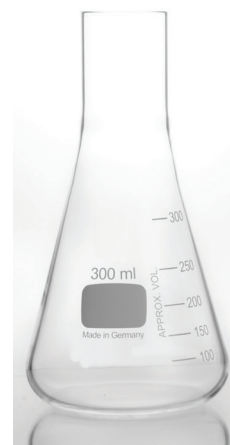

Culture bottles (BIOGEN)

- straight neck for metal caps, Ø 38mm
- made from Duran® tubing



Capacity	Flask Ø	Height	Order number
ml	mm	mm	
100	50	125	5 562 100
300	71	170	5 562 300
500	83	208	5 562 500
1000	105	240	5 562 001



Culture flasks (Fernbach)

- Fernbach type (regular or quad battled)
- straight neck for metal caps, Ø 38mm
- made of borosilicate glass

Capacity	Flask Ø	Height	Type	Order number
ml	mm	mm		
1800	200	155	regular	5 568 050
1800	200	155	quad battled	5 568 100



Caps and stopper for culture flasks with neck Ø 38mm

- for neck Ø 38mm
- metal caps made of stainless steel or aluminium
- cap stopper made of plated anodised coloured aluminium with internal spring in nickel-chromed steel

Type	Material	Color	for neck Ø	Order number
			mm	
Metal cap	stainless steel	grey	38	5 570 001
	aluminium	grey	38	5 570 002
Cap stopper	plated anodised aluminium with internal spring	silver	37 - 39	5 570 011
		blue	37 - 39	5 570 012
		red	37 - 39	5 570 013



Extraction apparatus - complete

- Soxhlet extraction
- with flask, extractor and condenser
- made of borosilicate glass

Extractor capacity	Flask capacity	Flask socket	Condenser length	Condenser cone	Order number
ml	ml	ST	mm	ST	
30	100	29/32	250	29/32	2 230 030
70	100	29/32	250	34/35	2 230 070
100*	250	29/32	250	45/40	2 230 100
150*	250	29/32	250	45/40	2 230 150
200*	250	29/32	250	45/40	2 230 200
250**	500	29/32	250	45/40	2 230 250
300**	500	29/32	250	60/46	2 230 300
500***	1000	29/32	250	60/46	2 230 500
1000	2000	29/32	250	71/51	2 230 001
2000	2000	29/32	300	45/40	2 230 002

* suitable for 6-places heating mantle with flask capacity 250/300ml, see page 48

** suitable for 3-/6-places heating mantle with flask capacity 500ml, see page 48

*** suitable for 3-places heating mantle with flask capacity 1000ml, see page 48



Separatory funnels - Squibb - stopper - ungraduated

- ST-PE stopper on top of funnel
- clear glass or amber stained
- made of borosilicate glass

Capacity	Stopcock	Socket	Bore of plug	Order number	
				clear glass	amber stained
ml		ST	mm		
50	solid ST-glass	19/26	2,5	2 647 050	2 647 050 BR
100		19/26	2,5	2 647 100	2 647 100 BR
250		29/32	2,5	2 647 250	2 647 250 BR
500		29/32	2,5	2 647 500	2 647 500 BR
1000		29/32	4,0	2 647 001	2 647 001 BR
2000		29/32	6,3	2 647 002	2 647 002 BR
50	ST-PTFE	19/26	2,5	2 658 050	-
100		19/26	2,5	2 658 100	-
125		19/26	2,5	2 658 125	-
250		29/32	2,5	2 658 250	-
500		29/32	2,5	2 658 500	-
1000		29/32	4,0	2 658 001	-
2000	29/32	6,3	2 658 002	-	



Separatory funnels - Squibb - stopper - graduated

- ST-PE stopper on top of funnel
- made of borosilicate glass

Capacity	Stopcock	Socket	Bore of plug	Order number
				clear glass
ml		ST	mm	
50	solid ST-glass	19/26	2,5	2 648 050
100		19/26	2,5	2 648 100
250		29/32	2,5	2 648 250
500		29/32	2,5	2 648 500
1000		29/32	4,0	2 648 001
2000		29/32	6,3	2 648 002
50	ST-PTFE	19/26	2,5	2 659 050
100		19/26	2,5	2 659 100
250		29/32	2,5	2 659 250
500		29/32	2,5	2 659 500
1000		29/32	4,0	2 659 001
2000		29/32	6,3	2 659 002

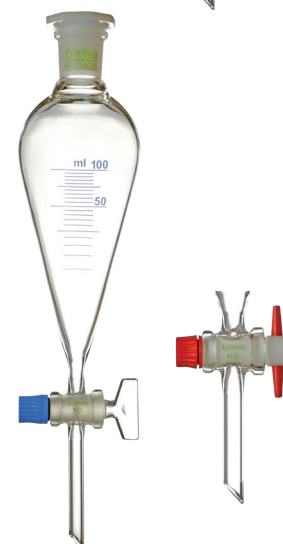

Consumables

Separatory funnels - DIN ISO 4800 conical shape - stopper - ungraduated

- ST-PE stopper on top of funnel
- clear glass or amber stained
- made of borosilicate glass

Capacity ml	Stopcock	Socket ST	Bore of plug mm	Order number	
				clear glass	amber stained
50	solid ST-glass	19/26	2,5	2 671 050	2 671 050 BR
100		19/26	2,5	2 671 100	2 671 100 BR
250		29/32	4,0	2 671 250	2 671 250 BR
500		29/32	4,0	2 671 500	2 671 500 BR
1000		29/32	6,3	2 671 001	2 671 001 BR
2000		29/32	6,3	2 671 002	2 671 002 BR
50	ST-PTFE	19/26	2,5	2 673 050	-
100		19/26	2,5	2 673 100	-
250		29/32	4,0	2 673 250	-
500		29/32	4,0	2 673 500	-
1000		29/32	6,3	2 673 001	-
2000		29/32	6,3	2 673 002	-
50	Witaflo needle valve	19/26	3,0	2 675 050	-
100		19/26	3,0	2 675 100	-
250		29/32	3,0	2 675 250	-
500		29/32	6,0	2 675 500	-
1000		29/32	6,0	2 675 001	-
2000		29/32	6,0	2 675 002	-



Separatory funnels - DIN ISO 4800 conical shape - stopper - graduated

- ST-PE stopper on top of funnel
- made of borosilicate glass

Capacity ml	Stopcock	Socket ST	Bore of plug mm	Order number
				clear glass
50	solid ST-glass	19/26	2,5	2 672 050
100		19/26	2,5	2 672 100
250		29/32	4,0	2 672 250
500		29/32	4,0	2 672 500
1000		29/32	6,3	2 672 001
2000		29/32	6,3	2 672 002
50	ST-PTFE	19/26	2,5	2 674 050
100		19/26	2,5	2 674 100
250		29/32	4,0	2 674 250
500		29/32	4,0	2 674 500
1000		29/32	6,3	2 674 001
2000		29/32	6,3	2 674 002
50	Witaflo needle valve	19/26	3,0	2 676 050
100		19/26	3,0	2 676 100
250		29/32	3,0	2 676 250
500		29/32	6,0	2 676 500
1000		29/32	6,0	2 676 001
2000		29/32	6,0	2 676 002



Separatory funnels - conical shape - screw thread - graduated

- screw thread and cap on top of funnel
- suitable for shaking apparatus
- made of borosilicate glass

NEW

Capacity ml	Stopcock	Thread GL	Bore of plug mm	Order number
				clear glass
50	economy needle valve	25	3,0	2 677 005
100		25	3,0	2 677 010
250		32	3,0	2 677 025
500		32	6,0	2 677 050
1000		32	6,0	2 677 100
2000		45	6,0	2 677 200



Staining jar complete

- with glass box, cover, slide frame and wire holder
- for 10 slides 76x26mm

Description	Order number	
	Soda glass	Borosilicate 3.3
Complete	4 640 000	4 640 000 B
Spare tray (slide frame)	4 640 001	4 640 001 B
Spare wire holder	4 640 002	4 640 002 B
Spare glass box and cover	4 640 003	4 640 003 B



Staining jar acc. to Hellendahl

- with glass box and cover
- standard and with enlargement
- for 16 slides 76x26mm

Description	Order number	
	Soda glass	Borosilicate 3.3
Standard	4 631 001	4 631 001 B
With enlargement	4 630 000	4 630 000 B



Staining jar acc. to Coplin

- with glass box and cover (glass or PP)
- for 10 slides 76x26mm

Description	Dimension	Order number	
		Soda glass	Borosilicate 3.3
Standard with glass cover	115 x 68 mm	4 650 000	4 650 000 B
Standard with PP screw cap	113 x 68 mm	4 651 000	4 651 000 B
Low form with PP screw cap	98 x 68 mm	4 652 000	4 652 000 B



Staining jar acc. to Schiefferdecker

- with glass box and cover
- for 10 slides 76x26mm

Description	Order number	
	Soda glass	Borosilicate 3.3
Complete	4 660 000	4 660 000 B



Description	Order number
Screw cap PP 55mm	4 652 100

Petri dish

- made of glass
- for highest requirements, free from bubbles and imperfections
- bottom and lid (inside / outside) absolutely plane

Height mm	Outer Ø mm	Order number		Order number	
		Pack	Soda glass	Pack	Borosilicate 3.3
12	40		5 830 001		-
12	50	18	5 830 012		-
15	60	18	5 830 002		-
15	80	18	5 830 003	24	5 830 003 B
15	100	18	5 830 004	36	5 830 004 B
20	100	18	5 830 005	36	5 830 005 B
20	120	18	5 830 006		-
25	150	18	5 830 007	36	5 830 007 B
30	180	9	5 830 008		-
30	200	10	5 830 009		-
50	200	10	5 830 010		-

Petri dish bacteriological

- made of clear PS
- packed in PE bags
- machine sterile or gamma radiated

Outer Ø mm	Machine sterile	Gamma radiation	with vents	Quantity in bag	Order number
55	X			15	5 488 001
55	X		X	15	5 488 002
55		X		15	5 488 003
55		X	X	15	5 488 004
90	X			20	5 488 011
90	X		X	33	5 488 012
90		X		20	5 488 013
90		X	X	33	5 488 014
100	X			11	5 488 031
100		X		11	5 488 032

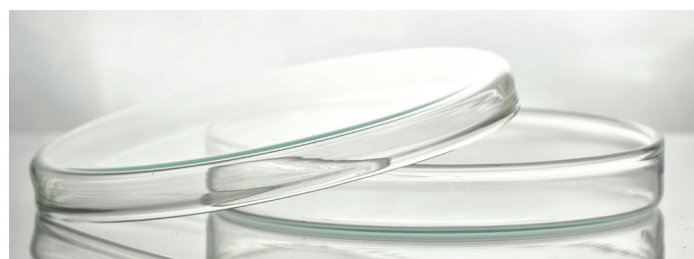

Consumables

Test tubes FIOLAX

- made of FIOLAX borosilicate glass 3.3
- with rim
- round bottom



pack = 100 pcs.

Length	Outer Ø	Order number
mm	mm	pack
70	8	4 902 001
100	10	4 902 002
100	12	4 902 003
100	16	4 902 004
130	14	4 902 005
160	16	4 902 006
180	18	4 902 007
180	20	4 902 008
200	25	4 902 009
200	30	4 902 010



Disposable culture tubes

- made of AR-glass
- plain top
- round bottom



pack = 250 pcs.

Length	Outer Ø	Order number
mm	mm	pack
70	10	4 925 001
75	12	4 925 002
100	12	4 925 003
100	16	4 925 004
125	16	4 925 005
130	13	4 925 008
160	16	4 925 006
180	18	4 925 007



Culture tubes plain top

- made of borosilicate glass 3.3
- plain top
- round bottom



pack = 100 pcs.

Length	Outer Ø	Wall	Order number
mm	mm	mm	pack
75	12	0.8-1.0	4 903 001
100	12	0.8-1.0	4 903 002
130	16	1.0-1.2	4 903 003
160	16	1.0-1.2	4 903 004
180	18	1.0-1.2	4 903 005
150	20	1.0-1.2	4 903 006
150	25	1.0-1.2	4 903 008
200	25	1.0-1.2	4 903 009
200	30	1.0-1.4	4 903 010
100	10	0.8-1.0	4 903 013
130	14	0.8-1.0	4 903 014
180	18	1.0-1.2	4 903 020



Test tubes with heavy wall (~1mm)

- made of AR-glass
- plain top
- round bottom



pack = 100 pcs.

Length	Outer Ø	Order number
mm	mm	pack
40	8	4 904 002
70	10	4 904 003
75	12	4 904 004
85	15	4 904 006
100	10	4 904 007
100	12	4 904 008
100	14	4 904 009
100	16	4 904 010
130	14	4 904 012
160	16	4 904 014
180	18	4 904 015



Culture tubes with rim

- made of borosilicate glass 3.3
- DIN12395
- round bottom



pack = 100 pcs.

Length	Outer Ø	Wall	Order number
mm	mm	mm	pack
70*	8	0.8-1.0	4 903 100
75	12	0.8-1.0	4 903 101
100	12	0.8-1.0	4 903 102
130	16	1.0-1.2	4 903 103
160	16	1.0-1.2	4 903 104
180	18	1.0-1.2	4 903 105
150	20	1.0-1.2	4 903 106
150*	25	1.0-1.2	4 903 108
200	25	1.0-1.2	4 903 109
200	30	1.0-1.4	4 903 110
100	10	0.8-1.0	4 903 113
130	14	0.8-1.0	4 903 114
180	18	1.0-1.2	4 903 120

* not according to DIN 12395



Test tube with spout and graduation

- made of borosilicate glass 3.3
- with rim and spout
- round bottom



Capacity	Division	Length	Outer Ø	Order number
ml	ml	mm	mm	
10	0.1	150	12	4 906 001
20	0.2	210	14	4 906 002
25	0.2	180	18	4 906 003
30	0.5	180	20	4 906 004



Test tubes

pack = 1000 pcs.

- made of clear PS or translucent PP

Volume ml	Ø x H mm	Material	Bottom	Order number pack
4	11 x 70	PS	round	5 449 001
4	12 x 55	PS	round	5 449 002
5	12 x 75	PS	round	5 449 003
5	12 x 75	PP	round	5 449 004
4,5	12 x 75	PS	conical	5 449 005
12	16 x 100	PS	round	5 449 006
12	16 x 100	PP	round	5 449 007
12	17 x 103	PS	conical	5 449 009
12	18 x 115	PS	conical	5 449 010
12	18 x 115	PS	round	5 449 011



Centrifuge tubes - conical bottom

- with and without rim
- with and without graduation

pack = 100 pcs.



Capacity ml	Dimensions mm	Wall thickness mm	Made of	Rim	Graduation	Order number pack
~15	112 x 17	0,8 - 1,0	AR-glass	-		4 860 001
~15	112 x 17	0,8 - 1,0	AR-glass	yes		4 860 004
~15	112 x 17	0,8 - 1,0	Borosilicate	yes		4 860 005
~10	98 x 17	0,8 - 1,0	AR-glass	-	-	4 865 001
~10	98 x 17	0,8 - 1,0	AR-glass	yes		4 865 002
~15	112 x 17	0,8 - 1,0	AR-glass	-	10ml:0.1	4 870 001
~15	112 x 17	0,8 - 1,0	AR-glass	yes	mark at 15ml	4 870 004
~15	112 x 17	0,8 - 1,0	AR-glass	-	15ml:0.1	4 875 001
~15	112 x 17	0,8 - 1,0	AR-glass	yes		4 875 004
~15	112 x 17	0,8 - 1,0	Borosilicate	yes		4 875 005

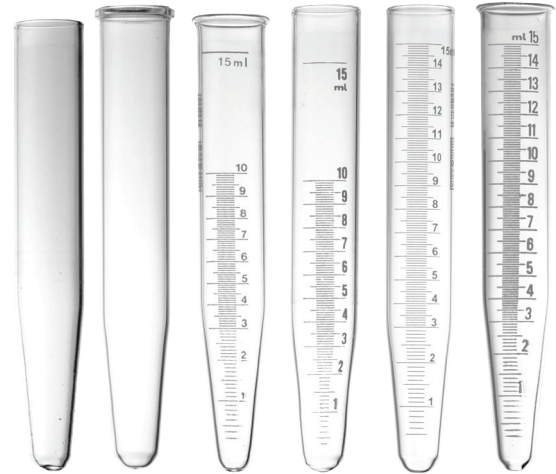

Centrifuge tubes - conical bottom 60° - heavy wall

- made of borosilicate glass 3.3

Capacity ml	Length mm	Outer Ø mm	Order number
15*	100	16	4 945 001
25	100	24	4 945 002
50	100	34	4 945 003
80	100	44	4 945 004
85	115	40	4 945 005

* conical bottom 30°



Centrifuge tubes graduated - heavy wall

- made of borosilicate glass 3.3



Capacity ml	Length mm	Outer Ø mm	Bottom	Graduation	Order number
15*	100	16	round	10ml:0.1	4 940 102
25*	100	24		20ml:0.1	4 940 103
50*	100	34		45ml:0.1	4 940 104
100*	100	44		85ml:0.1	4 940 105
250*	147	56		200ml:5	4 940 107
15	98	16	conical	10ml:0.1	4 945 101
25	98	24		20ml:0.1	4 945 102
50	98	34		45ml:0.1	4 945 103
100	98	44		85ml:0.1	4 945 104

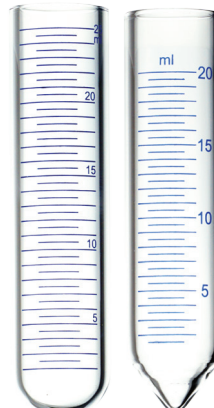

* according to DIN 58970 (Part 2)

Consumables

Centrifuge tubes - with screw cap - heavy wall

- made of borosilicate glass 3.3

Capacity	Length	Outer Ø	Bottom	Order number
ml	mm	mm		
15	98	16	round	4 945 201
25	98	24		4 945 202
50	98	34		4 945 203
80	98	44		4 945 204
15	98	16	conical	4 945 301
25	98	24		4 945 302
50	98	34		4 945 303
80	98	44		4 945 304



Centrifuge tubes graduated - with screw cap - heavy wall

- made of borosilicate glass 3.3

Capacity	Length	Outer Ø	Bottom	Order number
ml	mm	mm		
15	98	16	round	4 945 401
25	98	24		4 945 402
50	98	34		4 945 403
80	98	44		4 945 404
15	98	16	conical	4 945 501
25	98	24		4 945 502
50	98	34		4 945 503
80	98	44		4 945 504



Centrifuge tubes - BIOGEN

- made of borosilicate glass 3.3, heavy wall
- with screw cap

Volume	Length	Outer Ø	Division	Thread	Bottom	Order number
ml	mm	mm	ml	GL		
12	137	17	1	18	conical	4 946 001
15	140	17	1	18	conical	4 946 002
40	145	28	0-10 : 0.5 10-40 : 1.0	25	conical	4 946 003
50	140	28	0-10 : 0.5 10-50 : 1.0	25	shallow cone	4 946 101
10	97	20	-	18	round	4 947 001
35	100	28	-	18	round	4 947 002
50	140	28	-	25	round	4 947 003
140	152	60	0-3 : 0.5 3-10 : 1.0 10-20 : 2.0 20-50 : 3.0 50-125 : 5.0	-	conical	4 947 101
140	152	60	-	32	conical	4 947 201
590	175	95	-	32	conical	4 947 202
760	175	95	-	45	shallow cone	4 947 301
140	150	60	0-3 : 0.5 3-10 : 1.0 10-20 : 2.0 20-50 : 3.0 50-125 : 5.0	32	conical	4 947 401
200	173	60	0-3 : 0.5 3-10 : 1.0 10-20 : 2.0 20-50 : 3.0 50-125 : 5.0	32	conical	4 947 402



Centrifuge tubes

- made of PP
- autoclavable up to 121°C

Capacity	Length	Outer Ø	Bottom	Order number
ml	mm	mm		
7	100	12	round	7 271 001
16	100	18		7 271 002
31	95	24		7 271 004
48	100	30		7 271 005
75	100	35		7 271 006
110	120	40		7 271 007
10	108	16	conical	7 272 001
15	120	18	conical	7 272 002



Centrifuge tubes graduated

- conical bottom
- made of PP or PMP
- autoclavable up to 121°C (PP) or 170°C (PMP)

Capacity	Length	Outer Ø	Material	Order number
ml	mm	mm		
10	110	16	PP	7 273 001
15	118	18		7 273 002
10	110	16	PMP	7 273 101
15	118	18		7 273 102



Reaction vessels

- made of PP or PE
- with and without affixed lid (perforated)
- transparent

dustfree pack = 1000 pcs.

Volume	Lid	Material	Order number
ml			pack
0,25	Yes	PE	5 420 025
0,4		PE	5 420 000
0,7		PP	5 419 000
1,5		PP	5 417 000
1,9		PP	5 417 019
2,2		PP	5 417 022
1,5	-	PP	5 418 000
2,2	-	PP	5 418 022



Cryovials

- made of PP
- sterilized by radiation
- for deep freezing -20°C up to 196°C
- screw cap with seal joint
- white marking area

pack = 100 pcs.

Volume	Bottom	Order number
ml		pack
1,2	conical	5 485 001
2	round - self standing	5 485 002
4	round - self standing	5 485 003
5	round	5 485 004
2	round	5 485 005



Centrifuge tube ASTM D91 D96; 8 in.



- cylindrical with conical bottom
- borosilicate glass 3.3
- graduated
- marks at 50, 75 and 100ml

Volume	Division	Order number
ml		
100	0-0.5 : 0.05	4 955 010
	0.5-2 : 0.1	
	2-3 : 0.2	
	3-5 : 0.5	
	5-10 : 1	
	10-25 : 5	
	25-100 : 25	



Centrifuge tube ASTM D96



- pear shape with cylindrical bottom
- borosilicate glass 3.3
- graduated
- marks at 50 and 100ml

Volume	Division	Order number
ml		
100	0-1.5 : 0.1	4 956 010
	1.5-3 : 0.5	
	3-5 : 0.5	
	5-10 : 1.0	
	10-25 : 5	
	25-100 : 25	



Centrifuge tube ASTM D96; 6 in.



- cylindrical with conical bottom
- borosilicate glass 3.3
- graduated
- marks at 50 and 100ml

Volume	Division	Order number
ml		
100	0-0.5 : 0.05	4 957 010
	0.5-2 : 0.1	
	2-3 : 0.2	
	3-5 : 0.5	
	5-10 : 1	
	10-25 : 5	

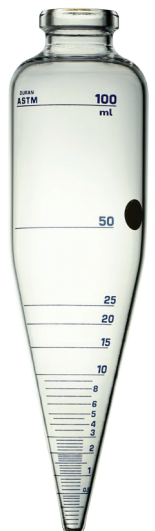

Consumables

Racks for test tubes, culture tubes and reaction vessels

- made of PP
- different colors available
- autoclavable up to 121°C
- detachable

Holes	Hole Ø mm	Dimensions mm	Order number			
			● white	● blue	● yellow	● red
100	micro tubes 1.5/2.0ml	262 x 108 x 45	7 073 102	7 073 102 BL	7 073 102 G	7 073 102 R
90	13	247 x 104 x 60	7 073 103	7 073 103 BL	7 073 103 G	7 073 103 R
60	16	247 x 104 x 70	7 073 104	7 073 104 BL	7 073 104 G	7 073 104 R
40	20	247 x 104 x 70	7 073 105	7 073 105 BL	7 073 105 G	7 073 105 R
40	25	297 x 124 x 85	7 073 106	7 073 106 BL	7 073 106 G	7 073 106 R
24	30	301 x 111 x 85	7 073 107	7 073 107 BL	7 073 107 G	7 073 107 R

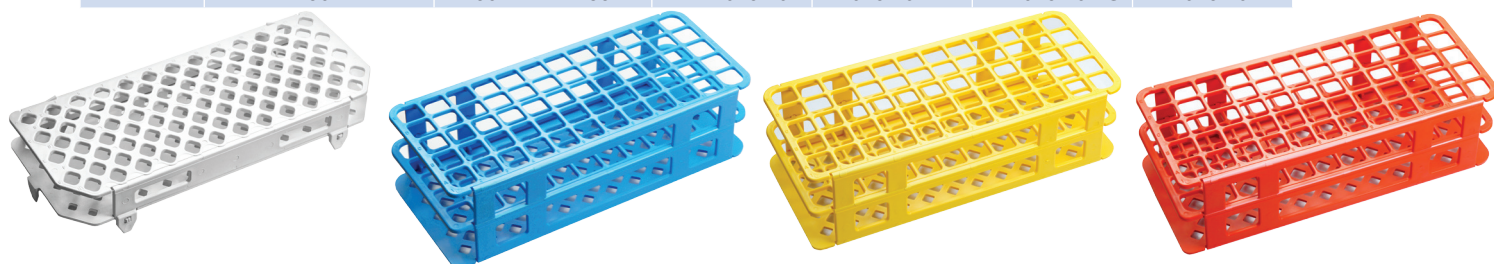

Racks for test tubes and culture tubes

- made of polished wood



Holes	Depth of holes mm	Deck height mm	Decks	Dimensions	Order number
				mm	
1 x 6	18	80	1	210 x 70 x 120	9 000 001
2 x 6				210 x 70 x 120	9 000 002
1 x 6			2	200 x 65 x 120	9 010 001
2 x 6				220 x 75 x 120	9 010 002
2 x 3				120 x 70 x 190	9 020 001
2 x 6				210 x 70 x 190	9 020 002
3 x 8	30	160	1	290 x 90 x 190	9 020 004
1 x 6				290 x 65 x 200	9 030 001
2 x 6			290 x 90 x 200	9 030 002	
2 x 3	18	80	1	120 x 70 x 190	9 040 001
2 x 6				210 x 90 x 190	9 040 002
2 x 12			2	370 x 90 x 190	9 040 004
4 x 12				370 x 190 x 150	9 040 006

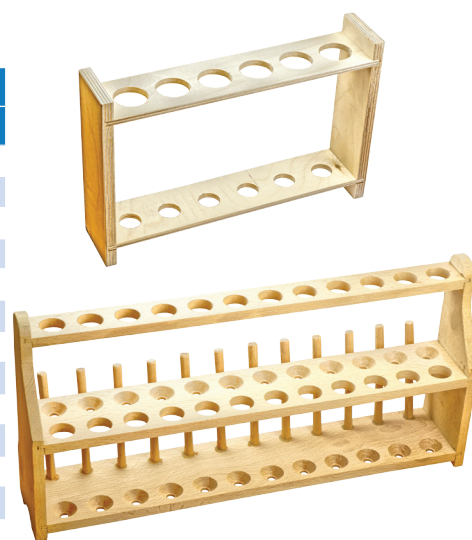

Tray for reaction vessels

- made of PP
- 20 places for 1.5ml vessels
- numeration from 1-20

Order number

5 416 000

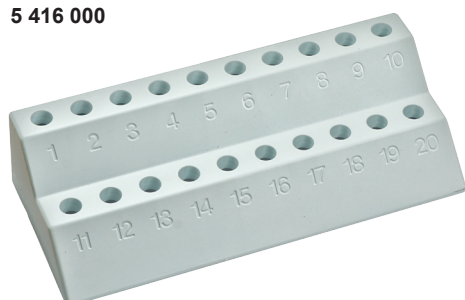

Racks for test tubes

- made of PP

Holes	Hole Ø	Dimensions mm	Order number
	mm		
10	19	250 x 50 x 75	7 068 001
24	21	375 x 65 x 85	7 068 002
12	21	190 x 60 x 80	7 069 002



Brushes

- for all laboratory purposes

For	Ø mm	Order number
pipettes	5	9 335 001
syringes	10	9 335 002
test tubes, wool tip	15	9 335 003
test tubes, wool tip	30	9 335 004
flasks and bottles	45	9 335 005
flasks and bottles	60	9 335 006
beakers	60	9 335 007
beakers	75	9 335 008
beakers	90	9 335 009
burettes	30	9 335 010
sieves	65	9 335 011

Set of 10 brushes

- various diameters from 10 - 80 mm

Order number

7 414 880



Parafilm „M“

- roll in dispenser box

Length m	Width mm	Order number
75	50	7 148 001
75	100	7 148 002
38	100	7 148 003



Witonex - cleaning concentrate

- detergent for all purposes
- ideal for glass, porcelain, plastic, rubber or metal
- ideal for medical, chemical and technical laboratories
- scentless and not harmful for skin or clothes
- highly concentrated (must be used diluted)
- trace free when used according to instructions

Type	Packed in	Content kg	Order number
WITONEX-30 standard	bottle	1	5 200 001
	canister	5	5 200 005
	canister	10	5 200 010
WITONEX-B-26 foam reduced	bottle	1	5 220 001
	canister	5	5 220 005
	canister	10	5 220 010



Consumables

Crucible - porcelain

- made of porcelain
- glazed
- crucible and lid (must be ordered separately)

low form

Top Ø	Height	Capacity	Order number	
			Crucible	Lid
30	19	5	8 518 002	8 518 102
35	22	10	8 518 003	8 518 103
40	25	17	8 518 004	8 518 104
45	28	21	8 518 005	8 518 105
50	32	34	8 518 006	8 518 106
70	44	91	8 518 007	8 518 107
83	55	180	8 518 009	8 518 109



medium form

Top Ø	Height	Capacity	Order number	
			Crucible	Lid
25	20	5	8 519 001	8 519 101
30	25	10	8 519 002	8 519 102
35	28	12	8 519 003	8 519 103
40	32	20	8 519 004	8 519 104
45	36	30	8 519 005	8 519 105
50	40	45	8 519 006	8 519 106
52	43	60	8 519 007	8 519 107
60	48	80	8 519 008	8 519 108
63	55	110	8 519 009	8 519 109
70	56	120	8 519 010	8 519 110
82	65	230	8 519 011	8 519 111
89	75	300	8 519 012	8 519 112



tall form

Top Ø	Height	Capacity	Order number	
			Crucible	Lid
26	34	11	8 520 003	8 520 103
30	38	15	8 520 004	8 520 104
35	44	26	8 520 005	8 520 105
40	50	35	8 520 006	8 520 106
45	56	50	8 520 007	8 520 107
50	62	72	8 520 008	8 520 108
60	75	130	8 520 009	8 520 109



Crucible - quartz-glass

- made of quartz-glass
- complete (crucible and lid)



low form

Top Ø	Height	Capacity	Order number
30	20	6	8 630 001
40	26	15	8 630 002
50	33	29	8 630 003
60	40	50	8 630 004
70	56	150	8 630 005

medium form

Top Ø	Height	Capacity	Order number
35	28	15	8 631 001
40	32	20	8 631 002
45	36	33	8 631 003
40	50	40	8 631 004
50	63	75	8 631 005

tall form

Top Ø	Height	Capacity	Order number
40	40	30	8 633 001
45	45	40	8 633 002
50	50	50	8 633 003
60	60	90	8 633 004
65	65	100	8 633 005



Weighing bottle tall form

- made of borosilicate glass 3.3
- with graduation and measures
- ST cover with knob



Capacity	Outer Ø	Height	Order number
ml	mm	mm	
10	25	40	2 870 005
15	30	40	2 870 006
20	30	50	2 870 007
30	35	50	2 870 008
40	40	50	2 870 009
45	40	60	2 870 010
45	40	65	2 870 011
45	35	70	2 870 012
70	40	80	2 870 013
120	50	80	2 870 014

Weighing bottle low form

- made of borosilicate glass 3.3
- with graduation and measures
- ST cover with knob



Capacity	Outer Ø	Height	Order number
ml	mm	mm	
6	25	25	2 872 001
7	30	30	2 872 003
10	35	30	2 872 004
15	40	30	2 872 002
30	50	30	2 872 005
45	60	30	2 872 006
80	80	30	2 872 008
35	40	40	2 872 009

Weighing bottle

- made of Polypropylene (PP)
- autoclavable, re-usable
- airtight

Capacity	Outer Ø	Height	Tare	Order number
ml	mm	mm		
23	30	48	8	7 064 001
20	40	29	8	7 064 002
60	40	69	14	7 064 003
30	49	29	10	7 064 004
50	59	34	18	7 064 005
190	59	88	28	7 064 006
360	70	118	40	7 064 007



Weighing funnel

- glass pointed
- for weighing of chemicals



Capacity	Outer Ø	Length	Order number
ml	mm	mm	
1	12	35	2 880 000
3	22	65	2 880 001
6	28	70	2 880 002
10	32	80	2 880 003
30	40	110	2 880 004
60	50	135	2 880 005
170	65	200	2 880 006



Glass scoop

- round with ground edges
- made of borosilicate glass 3.3



Length	Order number
mm	
82	2 880 101
95	2 880 102
137	2 880 103



Plane weighing glass

- acc. to Heidbrink



Order number
2 873 902



Coming soon

Autoclave (bench-top)

Home of Innovations

We hold frequent meetings and discuss with the customer about the needs within the laboratory branch.

As a result of these discussions we constantly improve existing devices and additionally announce new devices for the near future:

Bench-top autoclave

- ideal for dental, clinical, medical and biological areas
- 21.5 liter
- class B cycle
- pre- & post-vacuum drying
- HEPA filter
- 121°C - 134°C
- 2.4 bar
- CE certified



Published and created by:

witeg Labortechnik GmbH

Managing Directors: Gabriele Antlinger / Mario Swiegot

Companies Register: HRB 570317 Mannheim

VAT Identification Number: DE 160326716

Legal note:

Copyright 2017 by witeg Labortechnik GmbH, 97877 Wertheim, Germany

All rights reserved, especially the rights regarding pictures, graphics and texts (completely or partially) for any kind of copying (EN 2.23).

If you want to use pictures, graphics or texts from this catalogue please get into contact with us.

Due to constant technical improvements the actual product appearance might differ from the shown images.

ISO 9001 Certified
ISO 13485 Certified Products
CE-Marked Products
CE-MDD Marked Products
Validation (IQ & OQ) Service

www.witeg.de



witeg Labortechnik GmbH

Am Bildacker 16

D-97877 Wertheim

Phone:

+49 (0)9342 / 9301-0

Fax:

+49 (0)9342 / 9301-77

Internet:

www.witeg.de

E-Mail:

info@witeg.de

